

OPERATOR'S MANUAL

**MODEL 9424
QUAD-CHANNEL
DIGITAL OSCILLOSCOPE**

Serial Number _____

May 1991

TABLE OF CONTENTS

1 General Information

Initial Inspection	1
Warranty	1
Product Assistance	1
Maintenance Agreements	1
Document Discrepancies	2
Service Procedure	2
Return Procedure	2

2 Product Description

Introduction	3
Architecture	3
ADCs and Memories	3
Trigger	5
Automatic Calibration	5
Display	5
Manual/Remote Control	6
Specifications	6

3 Installation

Safety Information	13
Operating Voltage	13
Power On	13

4 Display Layout

Real Time Clock Field (I)	16
Menu Field (II)	16
Icon Field (III)	16
Trigger Delay Field (IV)	16
Time and Frequency Field (V)	16
Abridged Trigger Configuration Field (VI)	16
Abridged Front-Panel Status Field (VII)	17
Displayed Trace Field (VIII)	17
Message Field (IX)	18
Trigger Level Indicator Fields (X)	18

5 Manual Operation

Vertical Controls	19
Time-Base Controls	22
Probes	25
Bandwidth Limit	25
Trigger controls (Standard)	25
Displaying Traces	32
Display Control and Expansion	32
Standard Waveform Processing	36
Screen Adjustments	38
Cursors	39
Pulse Parameters	43
Remote Control and Interruption	49
Automatic Setup	49
Menu Field (II) Controls	49
Panel Status Menu	50
Memory Status Menu	52
Saving and Recall of Front-Panel Setups	59
Auxiliary Setups (6)	62
X versus Y Display	68
Persistence Display	71
Store Menu	73
Special Modes	75

6 The SMART Trigger

Introduction	77
Applications	77
Manipulating the SMART Trigger	85
Single-Source Trigger Modes	88
Multi-Source Trigger Modes	97

7 Pass/Fail Testing

Pass/Fail Display	114
Pass/Fail Setup	117
Test Parameters List	121

8	Extended Pulse Parameters	
	Extended Parameters Display	123
	Extended Parameters Setup	126
	Extended Parameters List	127
9	The Rear Panel	
	Mains Voltage Selection (67)	129
	Fuse Protection	129
	Power Switch (66)	129
	Accessory Power Connectors (73)	129
	GPIB and RS-232-C Port Selection (70)	130
	RS-232-C Connector (68)	130
	Accessory Control (69)	131
	BNC Connector (62)	131
	External CK Input (62)	131
	Sampling CK Output (63)	131
	Trigger Out (64)	131
	Trigger Veto (65)	131
	External Trigger (65)	132
	Reset (71)	132
10	Getting Started	
	Waveform Acquisition	133
	Saving and Recalling Front-Panel Setups	145
	Storing and Recalling Waveforms	146
	Waveform Expansion	147
	Waveform Processing	153
11	Getting More from your Oscilloscope	
	Rapid Response of the Front-Panel Controls	157
	Accurate Amplitude Measurements	157
	Accurate Time Measurements	159
	Auto-Calibration	161
12	Waveform Processing Option (WP01)	
	Processing Capabilities	163
	Summed Average	164
	Continuous Average	167
	Arithmetic	168
	Extrema	170
	Functions	171
	Enhanced Resolution	172

13 FFT Option (WP02)

Fourier Transform	183
FFT Power Average	186
Processing Facilities	187
Cursors	187
FFT Interruption (Abort)	188
FFT Algorithms	188
Examples of FFT Processing	191
FFT Glossary	194
Error Messages	198
References	199

14 Memory Card Option (MC01)

Memory Card Features	201
Memory Card Operation	202
File Naming	205
Memory Card Structure	206

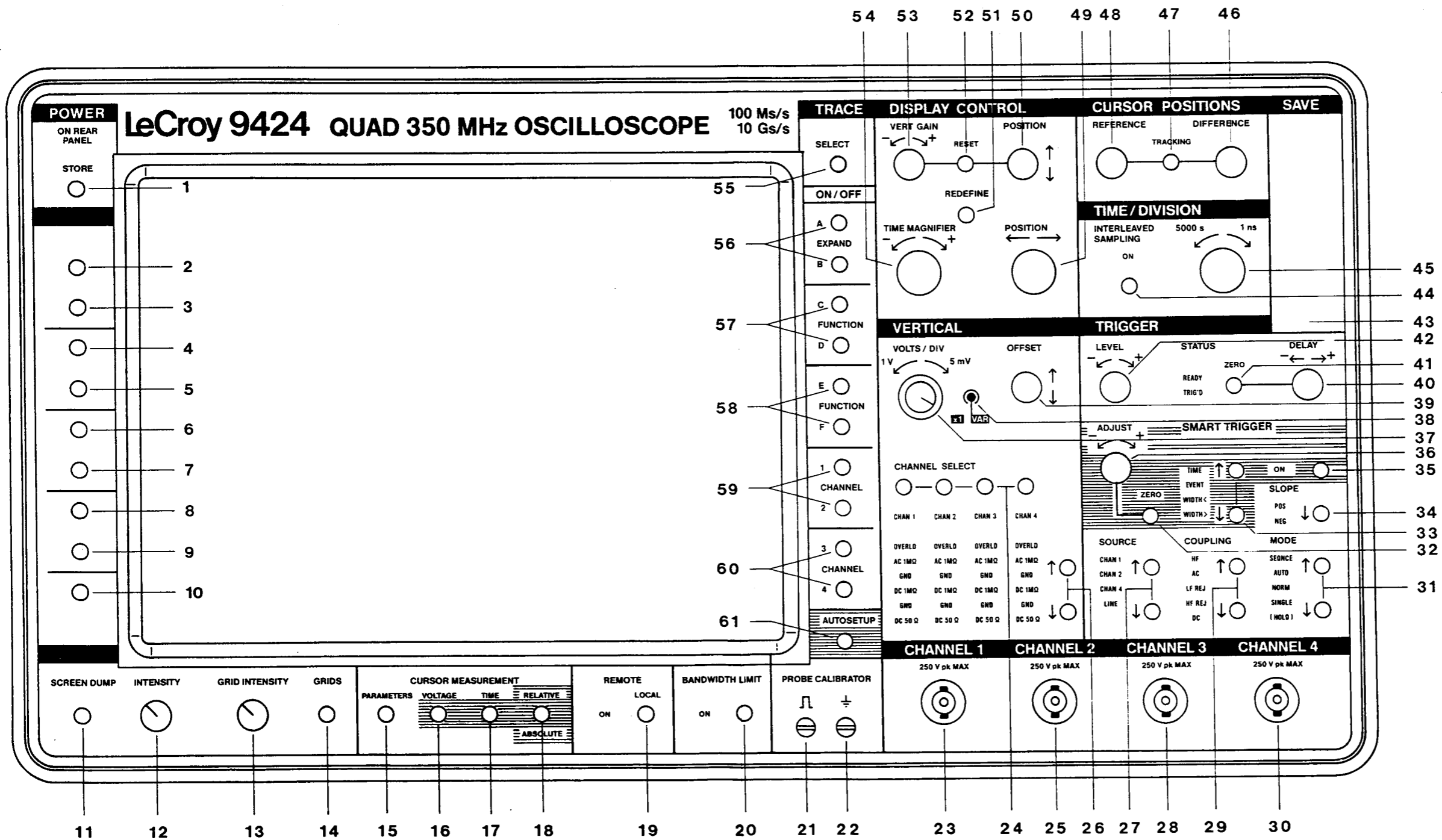

Figure 1: 9424 Front Panel

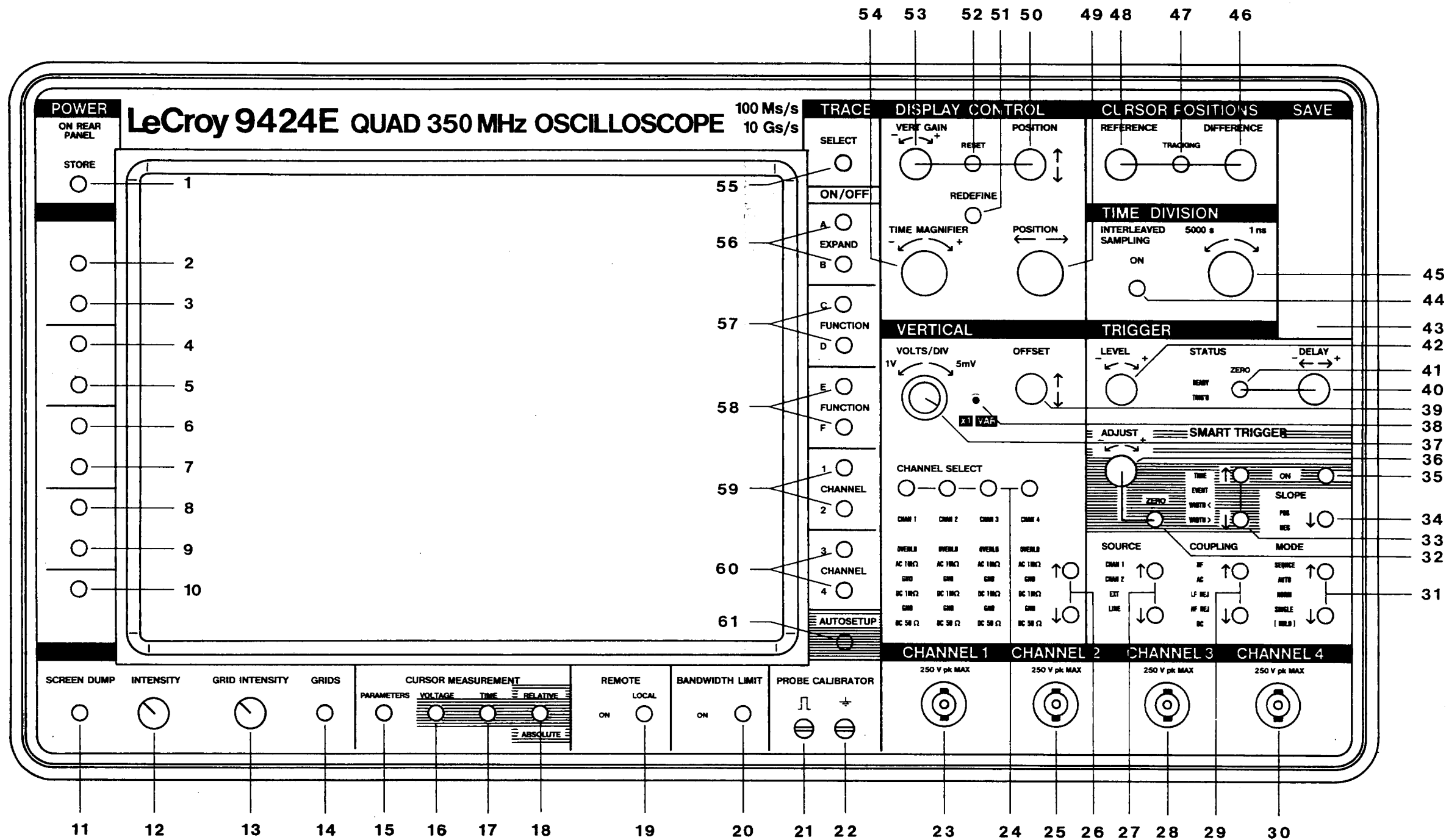

Figure 2: 9424E Front Panel

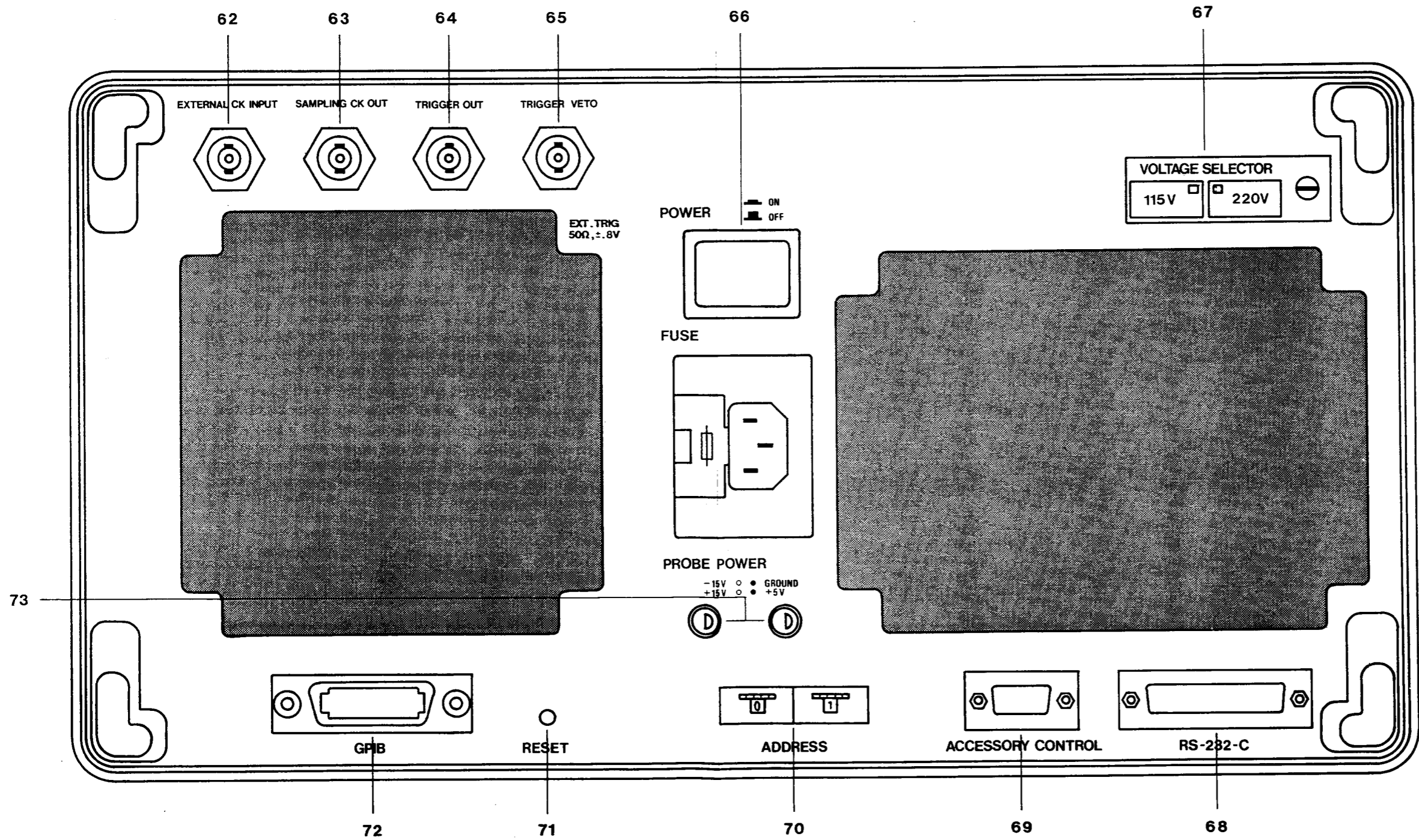

Figure 3: 9424 Rear Panel

INITIAL INSPECTION

It is recommended that the shipment be thoroughly inspected immediately upon delivery to the purchaser. All material in the container should be checked against the enclosed Packing List. LeCroy cannot accept responsibility for shortages in comparison with the Packing List unless notified promptly. If the shipment is damaged in any way, please contact the Customer Service Department or local field office immediately.

WARRANTY

LeCroy warrants its oscilloscope products to operate within specifications under normal use for a period of two years from the date of shipment. Spares, replacement parts and repairs are warranted for 90 days. The instrument's firmware is thoroughly tested and thought to be functional, but is supplied "as is" with no warranty of any kind covering detailed performance. Products not manufactured by LeCroy are covered solely by the warranty of the original equipment manufacturer.

In exercising this warranty, LeCroy will repair or, at its option, replace any product returned to the Customer Service Department or an authorized service facility within the warranty period, provided that the warrantor's examination discloses that the product is defective due to workmanship or materials and that the defect has not been caused by misuse, neglect, accident or abnormal conditions or operation.

The purchaser is responsible for transportation and insurance charges for the return of products to the servicing facility. LeCroy will return all in-warranty products with transportation prepaid.

This warranty is in lieu of all other warranties, expressed or implied, including but not limited to any implied warranty of merchantability, fitness, or adequacy for any particular purpose or use. LeCroy shall not be liable for any special, incidental, or consequential damages, whether in contract or otherwise.

PRODUCT ASSISTANCE

Answers to questions concerning installation, calibration, and use of LeCroy equipment are available from the Customer Service Department, 700 Chestnut Ridge Road, Chestnut Ridge, New York 10977-6499, U.S.A., tel. (914)578-6059, and 2, rue Pré-de-la-Fontaine, 1217 Meyrin 1, Geneva, Switzerland, tel. (41)22/719 21 11, or your local field engineering office.

MAINTENANCE AGREEMENTS

LeCroy offers a selection of customer support services. Maintenance agreements provide extended warranty and allow the customer to budget maintenance costs after the initial two year warranty has expired. Other services such as installation, training, enhancements and on-site repair are available through specific Supplemental Support Agreements.

DOCUMENTATION DISCREPANCIES

LeCroy is committed to providing state-of-the-art instrumentation and is continually refining and improving the performance of its products. While physical modifications can be implemented quite rapidly, the corrected documentation frequently requires more time to produce. Consequently, this manual may not agree in every detail with the accompanying product. There may be small discrepancies in the values of components for the purposes of pulse shape, timing, offset, etc., and, occasionally, minor logic changes. Where any such inconsistencies exist, please be assured that the unit is correct and incorporates the most up-to-date circuitry. In a similar way the firmware may undergo revision when the instrument is serviced. Should this be the case, manual updates will be made available as necessary.

SERVICE PROCEDURE

Products requiring maintenance should be returned to the Customer Service Department or authorized service facility. LeCroy will repair or replace any product under warranty at no charge. The purchaser is only responsible for transportation charges.

For all LeCroy products in need of repair after the warranty period, the customer must provide a Purchase Order Number before repairs can be initiated. The customer will be billed for parts and labor for the repair, as well as for shipping.

RETURN PROCEDURE

To determine your nearest authorized service facility, contact the Customer Service Department or your field office. All products returned for repair should be identified by the model and serial numbers and include a description of the defect or failure, name and phone number of the user, and, in the case of products returned to the factory, a Return Authorization Number (RAN). The RAN may be obtained by contacting the Customer Service Department in New York, tel. (914)578-6097, in Geneva, tel. (41)22/719 21 11, or your nearest sales office.

Return shipments should be made prepaid. LeCroy will not accept C.O.D. or Collect Return Shipments. Air-freight is generally recommended. Wherever possible, the original shipping carton should be used. If a substitute carton is used, it should be rigid and be packed such that the product is surrounded with a minimum of four inches of excelsior or similar shock-absorbing material. In addressing the shipment, it is important that the Return Authorization Number be displayed on the outside of the container to ensure its prompt routing to the proper department within LeCroy.

INTRODUCTION

The LeCroy 9424 is a wide-bandwidth digital oscilloscope suited to a variety of multi-channel engineering design and test applications. It is used to capture, analyze, display and archive electrical waveforms in fields such as analog and digital engineering, automated test and measurement, telecommunications and electronics research.

ARCHITECTURE

The 9424 features four 100 megasample/second 8-bit Flash ADC systems, with 50K non-volatile memories for waveform acquisition and storage, and four 50K memories for waveform processing, expansion and temporary storage. High-speed internal data transfer and processing are performed using a multi-processor system. The central processor is a powerful Motorola 68020 microprocessor which performs computations and controls the oscilloscope's operation.

All front-panel knobs and buttons are constantly monitored by the internal processor, and front-panel setups are rapidly reconfigured via the unit's internal 16-bit bus. Data are quickly processed according to the selected front-panel setups, and are transferred to the display memory for direct waveform display or stored in the reference memories.

The 68020 controls the unit's GPIB (IEEE-488) remote control port, as well as the RS-232-C port which is used to directly interface the oscilloscope to a digital plotter, printer, remote terminal or other slow-speed device.

ADCs AND MEMORIES

Each of the oscilloscope's four identical input channels is equipped with a 100 megasample/second, 8-bit ADC and a 50 kiloword acquisition memory (see Figure 1). This quad ADC architecture ensures absolute amplitude and phase correlation, maximum ADC performance for all single- and multi-channel acquisition modes, large record lengths and excellent time resolution.

Four 50K acquisition memories simplify transient capture by providing long waveform records that capture waveforms even when trigger timing or signal speed is uncertain. In addition, a special expansion facility magnifies waveforms by up to 1000 times the selected time-base speed.

Repetitive signals can be acquired and stored at a Random Interleaved Sampling (RIS) rate of 10 gigasamples/second. RIS is a high-precision digitizing technique that enables measurement of repetitive signals to a bandwidth of 350 MHz, with an effective sampling interval of 100 psec and measurement resolution of 5 psec.

The 9424 assures precision measurements over its entire range of operation.

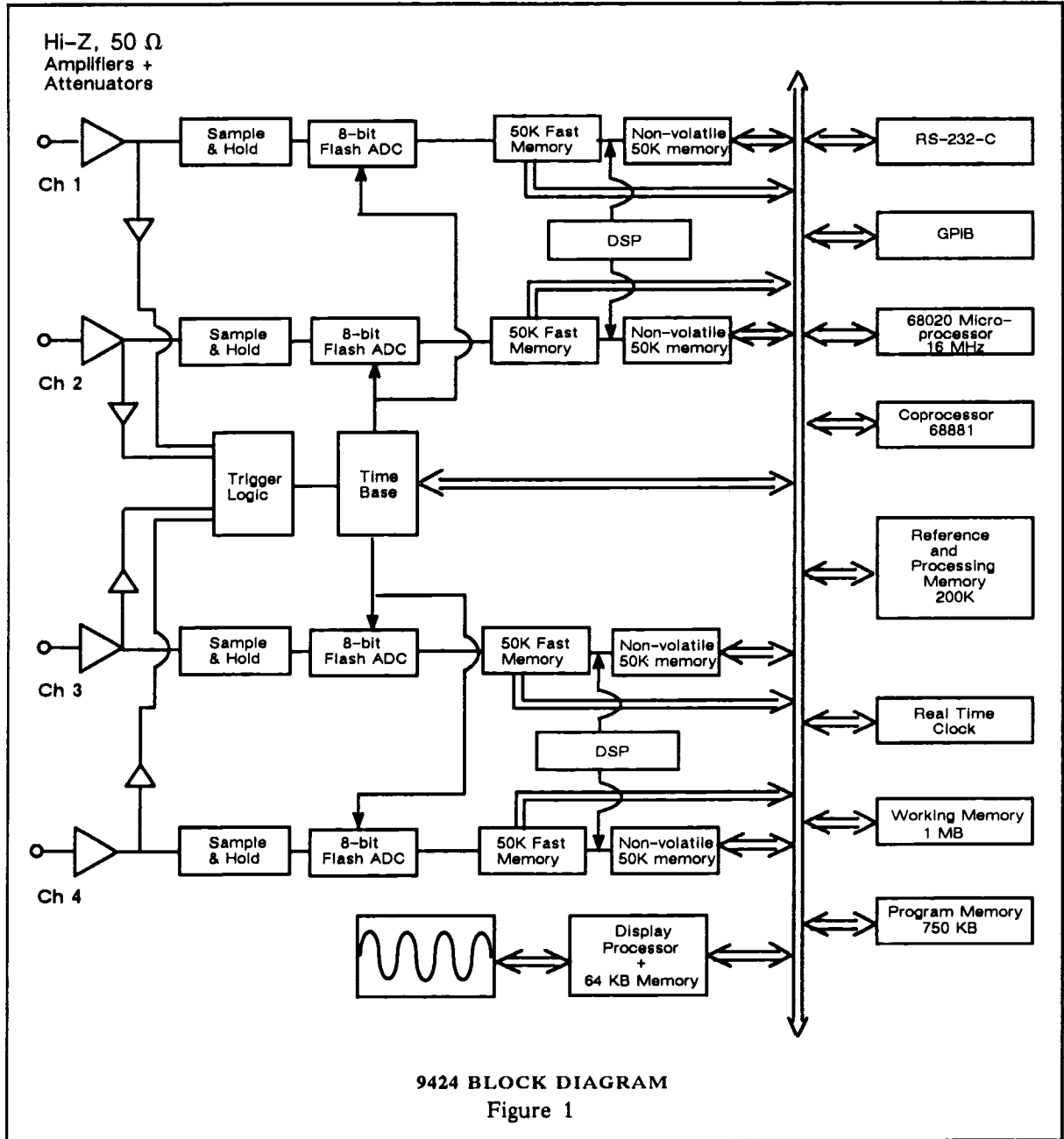

TRIGGER

The 9424's digitally-controlled trigger system offers an extensive range of trigger capabilities. Front-panel and menu controls let the user choose the appropriate trigger function for the signal.

In the standard trigger mode the front-panel controls are used to select and set parameters such as pre- and post-trigger recording, sequence and roll modes, in addition to the Auto, Normal and Single (Hold) modes. The trigger source can be line, Channel 1, 2 or 4 (Channel 4 is replaced by EXT on the 9424E). The coupling is selected from HF, AC, LF REJECT, HF REJECT and DC, and the slope from positive and negative.

The SMART trigger facility provides a complete range of sophisticated and versatile trigger features. The following trigger classes and operational modes are available:

Trigger Classes	Operational Modes
Single-source trigger Pattern trigger	Hold-off by time Hold-off by number of events Pulse width > Pulse width < (FASTGLITCH) Interval width > Interval width <
State Qualified trigger Time/Event Qualified trigger	Wait for a given time Wait for a given event count
TV trigger on Channel 3	Trigger on a given line in a chosen field

AUTOMATIC CALIBRATION

The oscilloscope has an automatic calibration facility that ensures overall vertical accuracy of $\pm 2\%$ of full scale ($\pm 3\%$ for 5mV/div sensitivity) and a time-base interpolator accuracy of ± 20 psec RMS for the unit's crystal-controlled time base.

The time base is calibrated whenever the time-base control is adjusted to a new Time/div setting; vertical gain and offset calibration take place each time the Volts/div or offset are modified. All channels are calibrated each time the Bandwidth Limit button is pressed. In addition, periodic calibration is performed to ensure long term stability at the current setting.

DISPLAY

The large 12.5 × 17.5 cm (5 × 7 inches) screen displays waveforms with enhanced resolution and serves as an interactive, user-friendly interface via a set of pushbuttons located immediately to the left and right of the CRT.

The oscilloscope displays up to four waveforms, while simultaneously reporting the parameters controlling signal acquisition. The screen also presents internal status and measurement results, as well as operational, measurement, and waveform analysis menus.

A hard copy of the screen is available via the unit's front-panel screen dump button. Plotting is done in parallel with normal oscilloscope operation.

MANUAL/REMOTE CONTROL

The front-panel layout and operation will be very familiar to users of analog oscilloscopes. The "analog" feel is emphasized by rapid instrument response and the fact that waveforms are presented instantly on the high-resolution screen.

The oscilloscope has also been designed for remote control operation in automated testing and computer-aided measurement applications. The entire measurement process, including cursor and pulse parameter settings, dynamic modification of front-panel settings, and display organization, can be controlled via the rear-panel GPIB (IEEE-488) and RS-232-C ports.

The 9424 can store up to seven front-panel setups which may be recalled either manually or by remote control, thus ensuring rapid front-panel configuration. When the power is switched off, the current front-panel setting is automatically stored for subsequent recall at the next power on.

SPECIFICATIONS

Vertical Analog Section

Bandwidth (-3 dB):

@ 50 Ω : DC to 350 MHz.

@ 1 M Ω AC: < 10 Hz to 250 MHz typical at the probe tip.

@ 1 M Ω DC: DC to 250 MHz typical at the probe tip.

Input impedance: 1 M Ω // 30 pF and 50 Ω \pm 1%.

Channels: Four independent channels; standard BNC connector inputs.

Sensitivity range: 5 mV/div to 2.5 V/div, continuously variable up to 2.5 times the fixed setting. Fixed settings range from 5 mV/div to 1 V/div in a 1, 2, 5 sequence.

Vertical expansion: up to 5 times (with averaging, up to 10 times or 500 μ V/div sensitivity).

Scale factors: Probe attenuation factors of $\times 1$, $\times 10$, $\times 100$, $\times 1000$ or $\times 10000$ may be selected and remotely programmed.

Offset: ± 12 times the fixed sensitivity setting in 0.02 division increments up to ± 10 V max.; ± 24 div @ 10 mV/div; ± 48 div @ 5 mV/div.

	<p>DC accuracy: $\leq \pm 2\%$.</p> <p>Bandwidth limiter: 80 MHz (- 3 dB) typical.</p> <p>Max input voltage: 250 V (DC + peak AC) at 1 MΩ, ± 5 V DC (500 mW) or 5 V RMS at 50 Ω.</p>
Vertical Digital Section	<p>ADCs: One per channel, 8-bit Flash.</p> <p>Conversion rate: Up to 100 megasamples/sec for transients, up to 10 gigasamples/sec for repetitive signals, simultaneously on four channels.</p> <p>Aperture uncertainty: ± 10 psec.</p> <p>Acquisition memories, Channels 1, 2, 3 and 4: Non-volatile memories (battery backed for a minimum of 2 years) of 50 kilowords per channel can be segmented into 2, 5, 10, 20, 50, 100 or 200 blocks.</p> <p>Reference and Function memories, C, D, E and F: 50K, 16-bit word memories which can store one acquired or processed waveform, or up to 200 waveform segments.</p>
Peak and Glitch Detection	<p>Minimum and maximum peaks, as fast as 0.002% of the record length (minimum 2.5 nsec), are captured and displayed with 100% probability.</p> <p>Using LeCroy's FASTGLITCH trigger technique (see the trigger section below), glitches faster than 2.5 nsec can be detected on all time-base settings.</p>
Horizontal Section	
Time Base	<p>Range: 1 nsec/div to 5000 sec/div.</p> <p>Clock accuracy: $\leq \pm 0.01\%$.</p> <p>Interpolator resolution: 5 psec.</p> <p>Sampling clock output: BNC connector on rear panel.</p> <p>External clock in: BNC connector on rear panel.</p>
Acquisition Modes	<p>Random Interleaved Sampling (RIS) for repetitive signals from 1 nsec/div to 20 μsec/div.</p> <p>Single shot for transient signals and repetitive signals from 50 nsec/div to 200 msec/div.</p> <p>Roll for slowly-changing signals from 500 msec/div to 5000 sec/div.</p> <p>Sequence mode divides the acquisition memory into 2, 5, 10, 20, 50, 100 or 200 segments.</p> <p>Horizontal expansion: Multi zoom mode allows different signals or different sections of the same signal to be expanded up to 1000 times.</p>

Trigger

Pre-trigger recording: Adjustable in 0.2% increments to 100% of full scale (grid width).

Post-trigger delay: Adjustable in 0.02 division increments up to 10,000 divisions.

Rate: Up to 500 MHz using HF trigger coupling.

Timing: Trigger timing (date and time) is listed in the memory status menu. The timing of subsequent triggers in sequence mode is measured with 0.1 sec absolute resolution, or nanosecond resolution relative to the time of the first trigger.

Trigger output: BNC connector on rear panel.

Trigger veto: BNC connector on rear panel.

Standard Trigger

Sources: Chan1, Chan2, Chan4, and Line. Chan 1, Chan2 and Chan4 have independent trigger circuits allowing slope, coupling and level to be set individually for each source. (Chan3 is used for the TV trigger).

◆ *Note: On the 9424E oscilloscope with External trigger option, Channel 4 is replaced by EXT. In this case, all references to Channel 4 should be interpreted as referring to EXT.*

Slope: Positive, negative.

Coupling: HF, AC, LF REJ, HF REJ, DC.

Modes

Auto: Automatically re-arms after each sweep. If no trigger occurs, one is generated at an appropriate rate.

Normal: Re-arms after each sweep. If no trigger occurs after a reasonable length of time, the warning message "No or Slow Trigger" is displayed.

Single (hold): Holds display after a trigger occurs. Re-arms only when the "single" button is pressed again.

Sequence: Stores multiple events in segmented acquisition memories.

SMART Trigger

Single-source trigger operational modes

Hold-off by time: 25 nsec to 20 sec.

Hold-off by events: 0 to 1,000,000,000 events.

Width-based trigger modes

Pulse width < (FASTGLITCH): Triggers on opposite slopes of pulses narrower than a value in the range 2.5 nsec to 20 sec.

Pulse width >: Triggers on opposite slopes of pulses wider than a value in the range 2.5 nsec to 20 sec.

Interval width <: Triggers on similar slopes of signals narrower than a value in the range 10 nsec to 20 sec.

Interval width >: Triggers on similar slopes of signals wider than a value in the range 25 nsec to 20 sec.

Multi-source trigger operational modes

Pattern: Triggers on the logical AND of Chan1, Chan2 and Chan4, where each source can be defined as high (H), low (L) or don't care (X). The trigger can be selected at the beginning (entered) or at the end (exited) of the specified pattern.

Bi-level: This is a special condition of pattern trigger which allows the oscilloscope to trigger on any signal that exceeds a certain preset high or low trigger level. The signal must be connected simultaneously to two channels. The third trigger channel must be set to don't care (X).

State qualified: Allows the oscilloscope to trigger on any source (Chan1, Chan2 or Chan4), while requiring that a certain pattern of the other two channels is present or absent. In addition a delay by time or by number of events can be selected from the moment the pattern is valid.

Time/Event qualified: Allows the oscilloscope to trigger on any source (Chan1, Chan2 or Chan4) as soon as a certain pattern of the three channels is entered or exited. From the moment of validity, a delay can be defined in terms of time or number of events.

- ◆ *Note: On the 9424E oscilloscope with External trigger option, Channel 4 is replaced by EXT. In this case all references to Channel 4 should be interpreted as referring to EXT.*

TV trigger operational modes

Allows stable triggering on TV signals that comply with PAL, SECAM or NTSC standards. Selection of both line and field number is possible. Active on Channel 3 only.

Any line: Triggers at the beginning of the front porch of a composite video signal applied to Channel 3.

Line mode: Triggers at the beginning of the front porch of a chosen line of a composite video signal applied to Channel 3.

Field choice: The user can select which field the chosen line should be in. The field can be specified in the range 1 to the total number of fields. This total number of fields can take one of the values 1, 2, 4 or 8. The hardware circuits can distinguish between the odd and even fields for the standard forms of TV signals.

Knowledge of the time interval between triggers allows the oscilloscope to make a "relative" distinction between fields 1, 3, 5, and 7 (or 2, 4, 6, and 8). This is the exclusive "FIELDLOCK" feature. It should be noted that this final field identification is not absolute.

The 9424 offers direct support for the two most common system characteristics 625/50/2:1 and 525/60/2:1. It also supports an extended class with arbitrary line count, 50 or 60 fields/sec, and arbitrary interlace factor.

Display

CRT: 12.5 × 17.5 cm (5 × 7 inches); magnetic deflection; vector type.

Resolution: 4096 × 4096 points.

Real-time clock: Date, hours, minutes, seconds.

Grid: Internally generated; separate intensity control for grid and waveforms. Single, dual, quad, XY and pulse parameter measurement grid modes.

XY mode: Plots any two sources (Chan1, 2, 3 and 4, Expand A and B, Functions C, D, E and F) against one another. Operates on live waveforms with cursor readout.

Hard copy: Single- or multi-pen digital plotters as well as IBM, HP QuietJet, ThinkJet, LaserJet and EPSON printers can be used to make hard copies of the display. Screen dumps are activated by a front-panel button or via remote control. Plotters supported are: the HP 7400 and 7500 series, Philips PM 8151, Graphtek FP 5301, and compatible models. Plotting can be done in parallel with normal operation.

Graphics: All waveforms and display information are presented using vector (linear) graphics. Expanded waveforms use LeCroy's DOT-LINEAR graphics that highlight actual data points and interpolate linearly between them.

Menus: Waveform storage; acquisition parameters; memory status; save/recall front-panel configurations; SMART trigger; RS-232-C configuration; hardcopy setup and real-time clock setup; waveform parameters; averaging, and arithmetic.

Cursors

Relative time: Two cursors provide time measurements with a resolution of $\pm 0.2\%$ of full scale for unexpanded traces; up to $\pm 10\%$ of the data point sampling interval for expanded traces. The corresponding frequency information is also provided.

Relative voltage: Two horizontal bars measure voltage differences up to $\pm 0.2\%$ of full scale for each trace in single grid mode.

Absolute time: A cross-hair marker measures time relative to the trigger as well as absolute voltage versus signal ground.

Absolute voltage: A reference bar measures absolute voltage with respect to ground.

Pulse parameters: Two cross-hair cursors are used to define a region of interest for which pulse parameters will be calculated automatically.

Auto-setup

Pressing the auto-setup button automatically scales the time-base, trigger and sensitivity settings to display a wide range of repetitive input signals.

Type of signals detected: Repetitive signals with amplitudes between 2 mV and 8 V, frequency above 50 Hz and a duty cycle greater than 0.1%.

Auto-setup time: Approximately 1 sec.

Waveform Processing

Waveform processing routines are called and set up via menus. These include arithmetic functions (add, subtract and invert), and summation averaging (up to 1000 signals).

Pulse parameters: Based on ANSI/IEEE Std 181-1977 "Standard on Pulse Measurement and Analysis by Objective Techniques". The terminology is derived from IEEE Std 194-1977 "Standard Pulse Terms and Definitions".

Automatic measurements determine:

Maximum	Period
Minimum	Pulse width
Mean	Risetime
Standard deviation	Falltime
RMS	Delay

Sources: Channel 1, Channel 2, Channel 3, Channel 4, Functions C, D, E or F, Expand A or B. Cursors define the measurement zone. With more than 1 pulse present in the measurement zone, averaged results for period, width, risetime and falltime are given.

2 Product Description

Optional Processing	Extra processing power can be added by installing LeCroy's waveform processing options. Option WP01 provides waveform characterization in high resolution mode up to 11 bits, and extended mathematical analysis (integration, differentiation, etc.), as well as averaging and extrema mode for the accumulation of maximum and minimum values. Option WP02 performs spectral analysis (FFT processing).
Remote Control	Front-panel controls, including variable gain, offset, position controls and cursors, as well as all internal functions are programmable. RS-232-C port: For computer/terminal control or plotter connection. Asynchronous up to 19200 baud. GPIB port: (IEEE-488). Configured as talker/listener for computer control and fast data transfer. Address switches on rear panel. Local/remote: Remote control can be interrupted for local (manual) control at any time (except when in remote control with the lock-out state selected) by pushing a button on the front panel.
Probes	Model: Four P9020 ($\times 10$, 10 M Ω // 3.33 pF) probes supplied. Probe calibration: 1 kHz square wave, 1 V p-p. Probe power: Two rear-panel power outlets for use with active probes provide ± 15 V, + 5 V DC.
Self Tests	Auto-calibration ensures : DC accuracy: $\pm 3\%$ full scale at 5mV/div $\pm 2\%$ full scale > 5mV/div Time accuracy: 20 psec RMS.
General	Temperature: 5 to 40° C (41 to 104° F) rated; 0 to 50° C (32 to 122° F) operating. Humidity: < 80%. Power required: 110 or 220 V AC, 45 to 440 Hz, 275 W. Battery backup: Lithium batteries maintain front-panel settings and waveform data for two years. Enclosure: (HWD) 21 x 37 x 50 cm (8½ x 14½ x 20 inches). Weight: 15 kg (33 lb) net, 20 kg (44 lb) shipping. Warranty: two years.

Arabic numerals relate to the numbering scheme used to refer to the front- and rear-panel controls and connectors in Figures A and B.

SAFETY INFORMATION

The oscilloscope has been designed to operate from a single-phase power source with one of the current-carrying conductors (neutral conductor) at ground (earth) potential. However, operation from power sources in which both current-carrying conductors are live with respect to ground (such as phase-to-phase on a tri-phase system) is also possible, as the oscilloscope is equipped with over-current protection for both mains conductors. None of the current-carrying conductors may exceed 250 V RMS with respect to ground potential. The oscilloscope is provided with a three-wire electrical cord containing a three-terminal polarized plug for mains voltage and safety ground connection. The plug's ground terminal is connected directly to the frame of the unit. For adequate protection against electrical hazard, this plug *must* be inserted into a mating outlet containing a safety ground contact.

The oscilloscope has not been designed to make direct measurements on the human body. Users who connect a LeCroy oscilloscope directly to a person do so at their own risk.

OPERATING VOLTAGE

The oscilloscope operates from a 115 V (90 to 132 V) or 220 V (180 to 250 V) nominal power source at 45 to 440 Hz. Prior to powering up the unit, make certain that the mains voltage for your area corresponds to the mains voltage value set on the oscilloscope. The currently set voltage is indicated by a green peg beside 115 V or 220 V on the **Voltage Selector** plate (67). If the indicated mains voltage differs from that used in your area, refer to Section 7, "The Rear Panel".

CAUTION

If a LeCroy oscilloscope set for 115 V is plugged into a 220 V power source, severe damage can occur. Before powering up the unit, ensure that the correct mains voltage has been set.

POWER ON

Check the items listed above. Connect the oscilloscope to the mains power using the mains cable supplied. The instrument may now be switched on by pressing the **Power** switch (66), located on the rear panel.

3 *Installation*

After the instrument is switched on, auto-calibration is performed and a test of the oscilloscope's ADCs and memories is carried out. The full testing procedure takes approximately 15 seconds, after which time a display will appear on the screen. The intensity controls ((12) and (13)) may be adjusted to suit the user.

In the following sections, Roman numerals in parentheses refer to the display field numbering scheme in Figure 2. Arabic numerals relate to the numbering scheme used to refer to the front- and rear-panel controls and connectors in Figures A, B and C.

The CRT area is divided between the centrally located grid and ten other fields (see Figure 2). Traces from the acquisition, reference or processing memories are displayed on the grid. A multi-grid system is also available by pressing button (14).

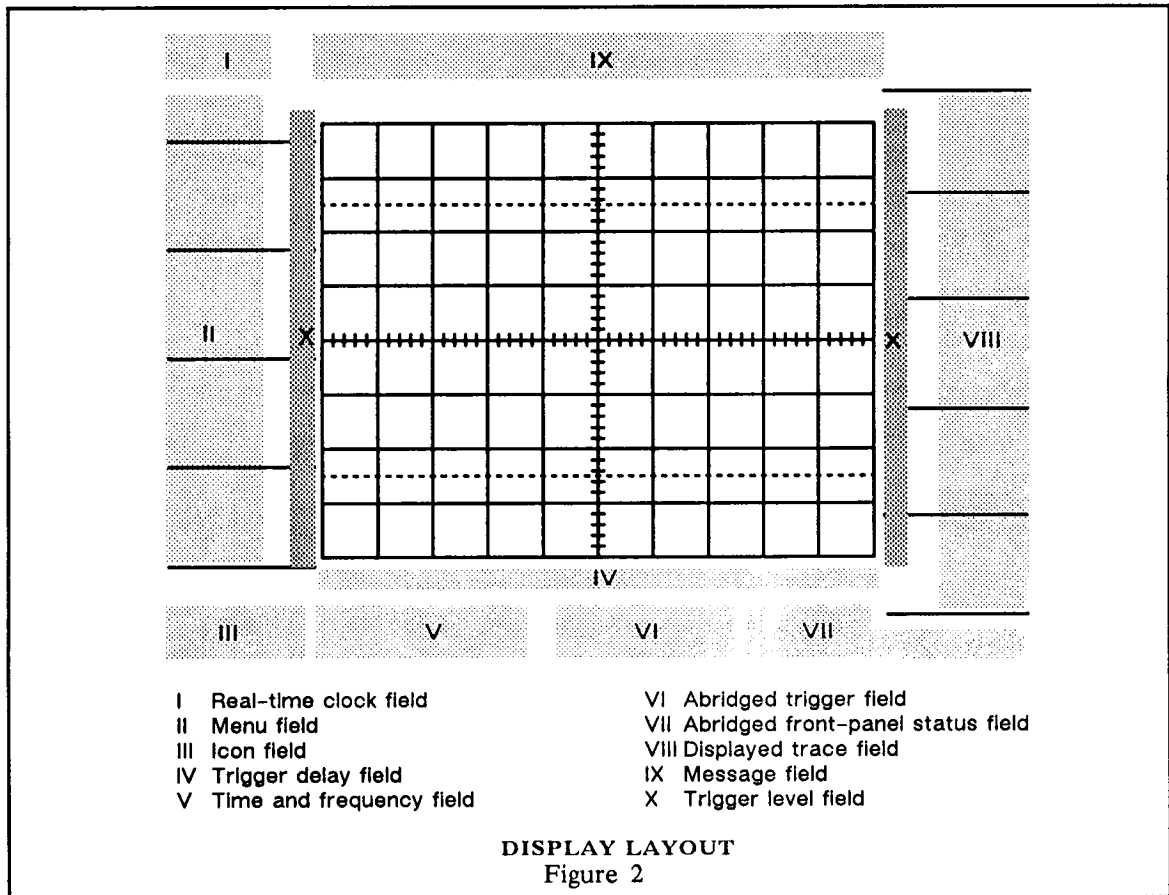

The ten fields are used to display such information as interactive menu queries and responses, current acquisition parameters, relative and absolute time and voltage measurements, as well as messages to assist the user.

REAL-TIME CLOCK FIELD (I)

This field displays the current date and time.

MENU FIELD (II)

This field is divided into nine sub-fields associated with menu keys (2) through (10). Each field may display the name of a menu or perform an operation when the associated menu key is pressed. The lowest field and related **Return** button (10) are used to restore the higher menu level.

ICON FIELD (III)

This field indicates when the oscilloscope is in the process of making a screen dump. The icon disappears when the screen dump is finished.

TRIGGER DELAY FIELD (IV)

This field indicates one of the two trigger delay modes. In the pretrigger mode, an upward-pointing arrow appears below the bottom line of the trace display grid. It is adjustable from 0 to 10 divisions, corresponding to a 0 to 100% pretrigger setting.

In the post-trigger mode, this arrow is replaced by a leftward-pointing arrow next to the post-trigger indication (in decimal fractions of a second) at the bottom of the grid. The maximum post-trigger setting corresponds to 10000 screen divisions.

TIME AND FREQUENCY FIELD (V)

When the absolute time cursor (cross-hair marker) is activated by using buttons (17) and (18), this field displays the time difference between the cross-hair marker and the point of triggering (common for all displayed traces).

When the relative time cursors (arrowhead cursors) are activated by using buttons (17) and (18), two readings are indicated. The upper reading indicates the time interval between the Reference and Difference arrowhead cursors, while the lower reading indicates the frequency corresponding to $1/(\text{time interval})$.

ABRIDGED TRIGGER CONFIGURATION FIELD (VI)

In the standard trigger mode, this field includes the trigger source, the trigger level and trigger coupling. A simple diagram, as shown in Figure 3, gives a visual overview of the trigger conditions.

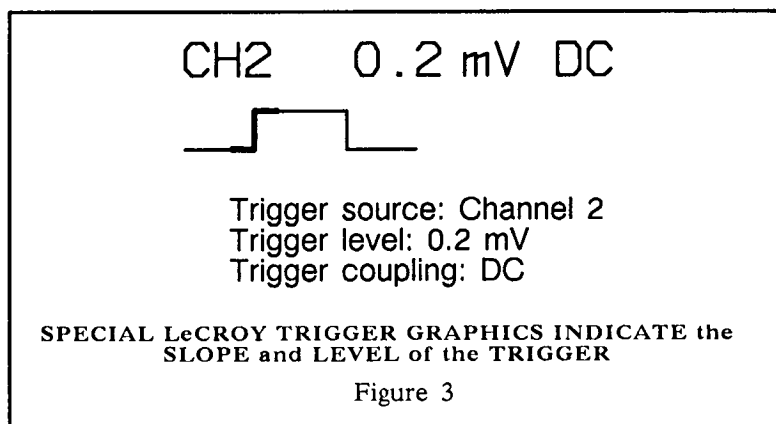

In the SMART trigger mode, the trigger source, level and coupling are listed. A diagram of the trigger configuration is given, as well as information on the logic states of Channel 1, Channel 2 and Channel 4. The hold-off by time or number of events, the pulse or interval width, and the trigger delay are also specified.

**ABRIDGED
 FRONT-PANEL
 STATUS FIELD (VII)**

This is a short-form display of the data acquisition parameters, and is updated whenever the oscilloscope's front-panel controls are manipulated. This field indicates the vertical sensitivity of Channels 1, 2, 3 and 4, the input couplings and the time base.

**DISPLAYED
 TRACE FIELD (VIII)**

The Displayed Trace field is associated with buttons (56)–(59). The data displayed in this field are the identity of the displayed trace, and the time-base and sensitivity settings for the acquired signal, as well as an indication of the position of the VAR sensitivity vernier (38). The symbol ">" appears when the vernier is not in the detent position (i.e. not in the fully clockwise position). Whenever Measurement Cursors (16) and (17) are activated, absolute or relative waveform voltage data are displayed in this field.

In XY mode, at the right-hand side of the trace identifier, the trace assigned to the X axis is labelled "X", and the trace assigned to the Y axis is labelled "Y".

A frame around one of the upper six signal sources in the Displayed Trace field indicates which of the traces is to be acted upon during manipulation of the various display controls ((49) through (54)). When **Multi Zoom** expansion is ON, there are two or more frames in the Displayed Trace field. A solid frame surrounds the currently selected expand function. The other expansion functions are surrounded by dashed frames.

MESSAGE FIELD (IX)

Messages appearing in this field indicate the oscilloscope's current acquisition status, or report improper manipulation of the front-panel controls. Figure 4 illustrates a typical message displayed in the Message field.

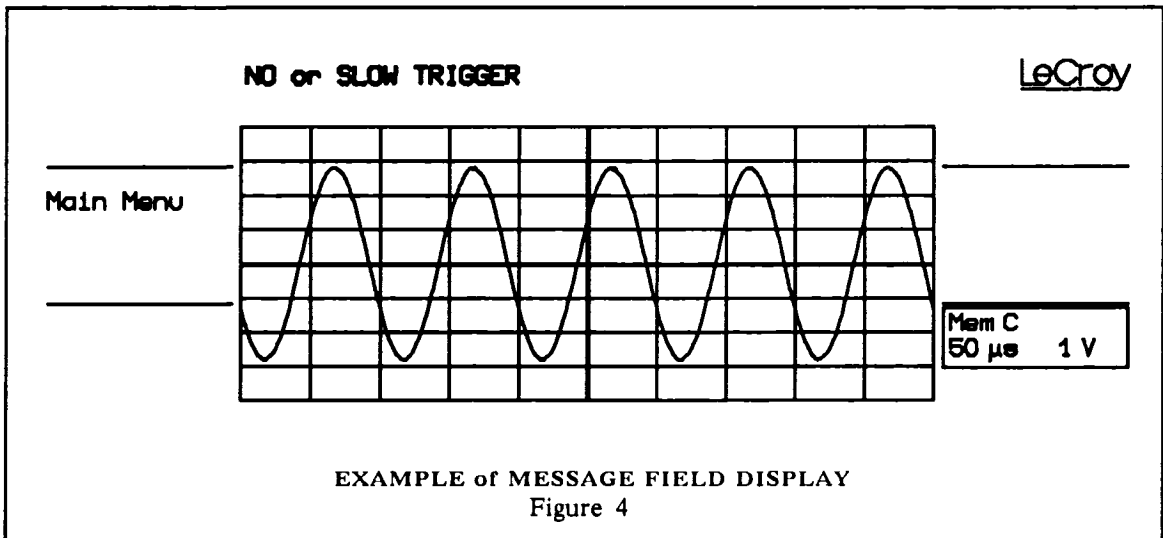

TRIGGER LEVEL INDICATOR FIELDS (X)

Two indicators (\blacktriangleright and \blacktriangleleft) on each side of the grid give a visual indication of the trigger level.

Note: In the following sections, roman numerals in parentheses refer to the display field numbering scheme in Figure 2. Arabic numerals in parentheses relate to the numbering scheme used to refer to front- and rear-panel controls and connectors in Figures A, B and C.

VERTICAL CONTROLS

INPUT CONNECTORS ((23), (25), (28), (30)) – BNC type connectors are used for **Channel 1**, **Channel 2**, **Channel 3** and **Channel 4**. The maximum permissible input voltage is 250 V (DC + peak AC \leq 10 kHz).

CHANNEL SELECT buttons (24) – To select a channel for individual adjustment of coupling, vertical sensitivity and offset, use buttons (24). The channel indicator LED lights up when a channel has been selected.

SIGNAL COUPLING and **INPUT IMPEDANCE** buttons (26) – Select the method used to couple the signal to the vertical amplifier input.

Possible selections: **AC**, **GND**, **DC** with 1 M Ω impedance
DC with 50 Ω impedance.

In the **AC** position, signals are coupled capacitively, thus blocking the input signal's DC component and limiting the signal frequencies below 10 Hz.

In the **DC** position, all signal frequency components are allowed to pass through, and 1 M Ω or 50 Ω may be chosen as the input impedance. The user should note that with 1 M Ω input impedance the bandwidth is limited to approximately 250 MHz.

The maximum dissipation into 50 Ω is 0.5 W, and inputs will automatically be disconnected whenever this occurs. A warning LED (**Overld**) lights up indicating when an overload condition has been detected. The input coupling LED is simultaneously switched to **GND**. The overload condition is reset by removing the signal from the input and selecting the 50 Ω input impedance again.

VOLTS/DIV knob (37) – Selects the vertical sensitivity factor in a 1–2–5 sequence. The sensitivity range is 5 mV to 1 V/div at both 1 M Ω and 50 Ω input impedances when the **VAR** vernier (38) is in the detent position, i.e. turned fully clockwise.

The **Volts/Div** (Figure 5) settings for each channel are permanently displayed, along with the signal input coupling and the time-base setting, in the Abridged Front Panel Status Field (VII) (Figure 2). The **Volts/Div** setting may be modified manually or via remote control, and is immediately updated.

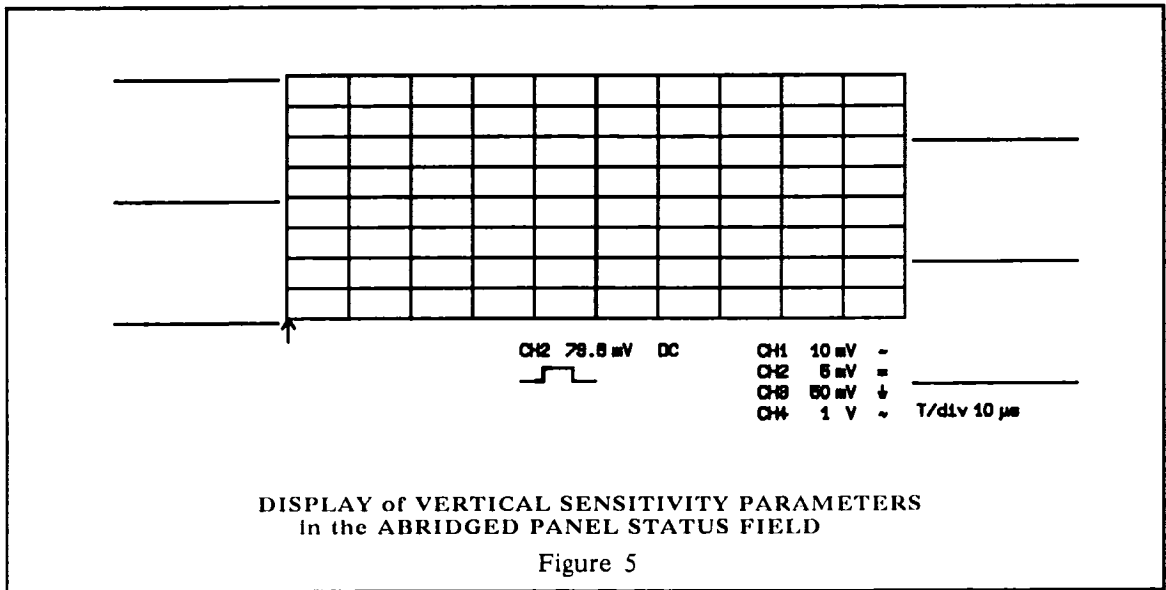

Figure 5

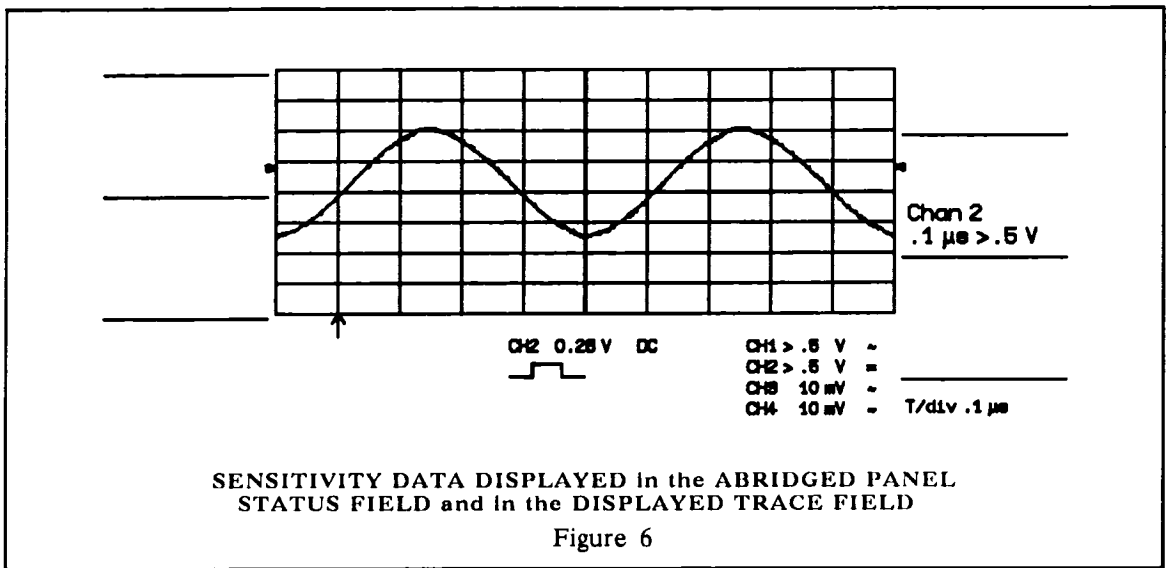

Figure 6

Whereas the acquisition control settings displayed in the Abridged Front-panel Status field (VII) are updated immediately upon manual or remote modification of the **Volts/Div** or **Time/Div** settings, the control settings in the Displayed Trace field (VIII), corresponding to the conditions under which the waveform was stored, are only updated with every waveform acquisition (see Figure 6).

VAR knob (38) – Verniers provide continuously variable sensitivity within the **Volts/Div** settings and extend the maximum vertical sensitivity to up to 2.5 V/div. Variable sensitivity settings are indicated by the symbol “>” in the lower portion of the Abridged Front-panel Status field (Figure 6) and the calibrated value appears in the **Total V/div** field of the Panel Status menu. (Minimum sensitivity is achieved by rotating the vernier counter-clockwise.)

VERTICAL OFFSET knob (39) – This knob vertically positions the displayed trace. At most of the voltage settings the maximum offset is ± 12 times the fixed sensitivity setting and is manually adjustable (or programmable) in 0.02 division increments. The maximum ranges depend on the fixed sensitivity setting as follows:

Fixed Sensitivity	Offset Range	Voltage
1 V	± 10 times	$\pm 10V$
0.5 V to 20 mV	± 12 times	$\pm 6 V$ to $\pm 240 mV$
10 mV	± 24 times	$\pm 240 mV$
5 mV	± 48 times	$\pm 240 mV$

A pair of upward- or downward-pointing, double-shaft arrows indicates when the trace has been positioned outside the grid, as shown in Figure 7.

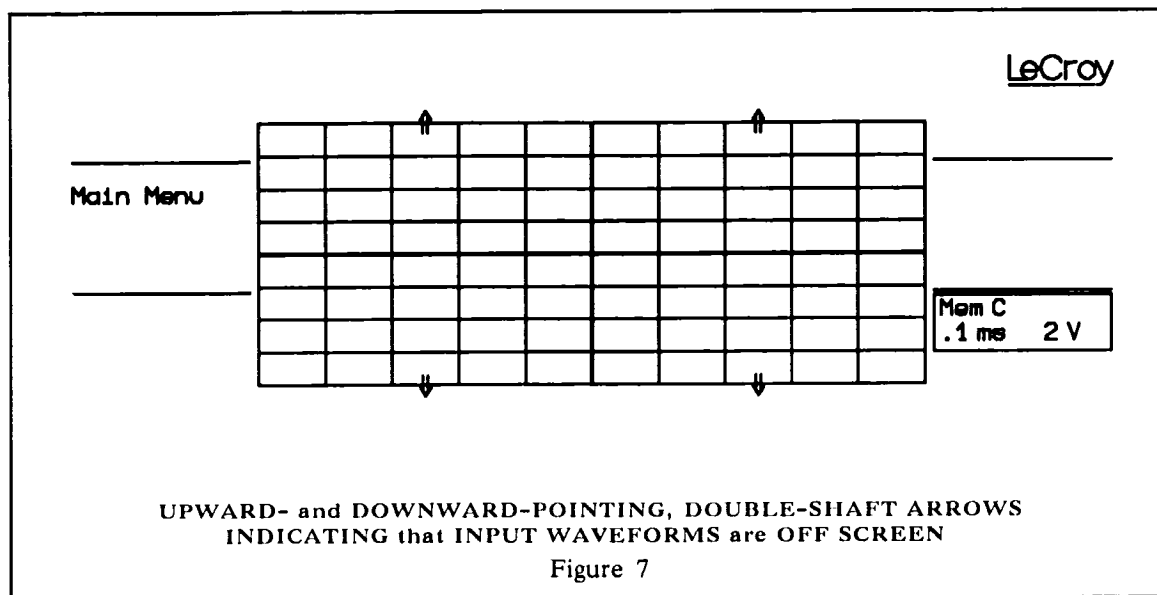

TIME-BASE CONTROLS

TIME/DIVISION knob (45)– This control selects the time per division in a 1–2–5 sequence from 1 nsec to 5000 sec. The time base is displayed in the **Abridged Front-panel Status** field (VII) as well as in the **Displayed Trace** field (VIII). The time base is crystal-controlled and features an overall accuracy better than $\pm 0.01\%$.

Sampling Modes

Depending on the time-base setting, the following three sampling modes are possible (see Table 1):

- Random Interleaved Sampling (RIS)
- Single Shot (SS)
- Roll Mode

Random Interleaved Sampling (RIS): At time-base settings from 1 nsec/div to 20 nsec/div, the RIS mode is always used for signal acquisition. Repetitive waveforms and a stable trigger are required. Waveforms can be digitized with sample intervals as small as 100 psec for an equivalent sampling rate of up to 10 gigasamples/sec.

Between 50 nsec/div and 20 μ sec/div, the oscilloscope can operate in either RIS or single-shot modes. The user may select the RIS acquisition mode by pressing the **Interleaved Sampling** button (44). When the LED is lit, the RIS mode is on.

Single Shot: Between 50 nsec/div and 20 μ sec/div, the user may select the single-shot acquisition mode by pressing the **Interleaved Sampling** button (44). When the LED is not lit the oscilloscope is in the single-shot mode.

Waveforms can be recorded in a single acquisition for time-base settings between 50 nsec/div and 200 msec/div. Sampling rates up to 100 megasamples/sec are possible in the single-shot mode.

When the time base is set so that 200 or less points are acquired, the oscilloscope indicates the measured points by highlighting them and interpolating linearly between them.

Roll: From 500 msec to 5000 sec/div, the samples continuously. The display is rapidly updated using newly acquired data points, and this results in the trace moving from right to left in a manner similar to that produced by a strip-chart recorder.

TIME BASE		SAMPLING RATE TIME/POINT		DISPLAYED RECORD LENGTH (Points)	
TIME/DIV		RIS	SS	RIS	SS
1	nsec	100 psec	---	100	---
2	nsec	100 psec	---	200	---
5	nsec	100 psec	---	500	---
10	nsec	100 psec	---	1000	---
20	nsec	100 psec	---	2000	---
50	nsec	100 psec	10 nsec	5000	50
0.1	μsec	100 psec	10 nsec	10000	100
0.2	μsec	100 psec	10 nsec	20000	200
0.5	μsec	100 psec	10 nsec	50000	500
1	μsec	250 psec	10 nsec	40000	1000
2	μsec	500 psec	10 nsec	40000	2000
5	μsec	1 nsec	10 nsec	50000	5000
10	μsec	2.5 nsec	10 nsec	40000	10000
20	μsec	5 nsec	10 nsec	40000	20000
50	μsec	---	10 nsec	---	50000
0.1	msec	---	25 nsec	---	40000
0.2	msec	---	50 nsec	---	40000
0.5	msec	---	0.1 μsec	---	50000
1	msec	---	0.25 μsec	---	40000
2	msec	---	0.5 μsec	---	40000
5	msec	---	1 μsec	---	50000
10	msec	---	2.5 μsec	---	40000
20	msec	---	5 μsec	---	40000
50	msec	---	10 μsec	---	50000
0.1	sec	---	25 μsec	---	40000
0.2	sec	---	50 μsec	---	40000
ROLL MODE					
0.5	sec	---	0.1 msec	---	50000
1	sec	---	0.25 msec	---	40000
2	sec	---	0.5 msec	---	40000
5	sec	---	1 msec	---	50000
10	sec	---	2.5 msec	---	40000
20	sec	---	5 msec	---	40000
50	sec	---	10 msec	---	50000
100	sec	---	25 msec	---	40000
200	sec	---	50 msec	---	40000
500	sec	---	0.1 sec	---	50000
1	ksec	---	0.25 sec	---	40000
2	ksec	---	0.5 sec	---	40000
5	ksec	---	1 sec	---	50000

LIST of SAMPLING MODES, SAMPLING RATE,
and DISPLAYED RECORD LENGTH for each TIME-BASE SETTING

Table 1

PROBES

Four Model P9020 passive probes are supplied with the oscilloscope. These probes have 10 M Ω input impedance and 16 pF capacitance. The system bandwidth with these probes is DC to 250 MHz (typical) in 1 M Ω DC coupling, and > 10 Hz to 250 MHz in AC coupling. Active FET probes (Tektronix models P6201, P6202a and P6230) may be powered via probe power connectors on the rear panel.

PROBE CALIBRATION outputs (21), (22)– To calibrate the P9020 probe, connect it to one of the input channels BNC connectors (23), (25), (28) or (30). Connect the probe's grounding alligator clip to the front panel ground lug (22) of the oscilloscope and connect the tip to lug (21).

Adjust the oscilloscope's front-panel controls as described in Section 8. If over- or undershoot of the displayed signal occurs, it is possible to adjust the probe by inserting the small screwdriver, supplied with the probe package, into the trimmer on the probe's barrel and turning it clockwise or counter-clockwise to achieve the optimal square-wave contour.

BANDWIDTH LIMIT

By setting the **Bandwidth Limit** button (20) to ON, the bandwidth can be reduced from 350 MHz to 80 MHz (–3 dB). Bandwidth limiting may be useful in reducing signal and system noise or preventing high-frequency aliasing. For example, bandwidth limiting reduces any high-frequency signals that may cause aliasing in single-shot applications using time-base settings faster than 0.1 msec/division.

TRIGGER CONTROLS (STANDARD)

Two basic trigger modes are available. The standard trigger facilities are described below. For a full description of the SMART trigger facilities refer to Section 6.

The standard trigger has a single source and is completely controlled from the front panel. SMART trigger functions are selected by pressing the **SMART Trigger** button (35) which switches "ON" the adjacent LED. Pressing the **SMART Trigger** button again, switches off the LED and returns the oscilloscope to standard trigger control. SMART trigger functions are inspected and modified using a display menu.

This section includes full details of how the standard trigger is configured and deals with the following:

- Trigger sources
- Trigger coupling
- Trigger adjustment (delay, level and slope)
- Trigger mode
- Trigger status
- Standard trigger graphics

TRIGGER SOURCE buttons (27)– Allow the trigger source to be selected as follows:

Chan 1: Selects Channel 1 as the trigger source, i.e. the signal connected to the Channel 1 BNC input connector (23).

Chan 2: Selects Channel 2 as the trigger source, i.e., the signal connected to the Channel 2 BNC input connector (25).

Chan 4: Selects Channel 4 as the trigger source, i.e., the signal connected to the Channel 4 BNC input connector (30).

◆ *Note: On the 9424E oscilloscope with External trigger option, Chan4 is replaced by EXT. During transition into EXT source a message is displayed on the screen reminding the user that the connector is on the back panel. The input signal must be between -0.8 V and $+0.8\text{ V}$.*

Warning: signals exceeding this range may damage the External trigger circuitry.

Line: Selects the line voltage which powers the oscilloscope to provide a stable display of signals synchronous with the power line.

Trigger Coupling

TRIGGER COUPLING buttons (29)– Select the type of signal coupling at the input of each trigger circuit. Note that the trigger coupling can be adjusted independently for each trigger source. Therefore, a change of the trigger source may also result in a change of the trigger coupling LEDs since the coupling associated with the newly selected source is remembered.

HF: Used for triggering on high frequency repetitive signals in excess of 300 MHz. Trigger rates up to 500 MHz are possible. HF triggering should be used only when needed. This coupling is automatically set to DC if it is incompatible with the trigger mode, for example when pulse or interval width triggering or TV trigger is being used (see Section 6). Only a positive trigger slope is possible.

AC: Signals are capacitively coupled; DC levels are rejected and frequencies below 50 Hz are attenuated.

LF REJ: Signals are coupled via a capacitive high-pass filter network. DC is rejected and signal frequencies below 50 kHz are attenuated. The **LF REJ** trigger mode is used when stable triggering on medium to high frequency signals is desired.

HF REJ: Signals are DC coupled to the trigger circuit and a low-pass filter network attenuates frequencies above 50 kHz. The **HF REJ** trigger mode is used to trigger on low frequencies.

DC: All of the signal's frequency components are coupled to the trigger circuit. This coupling mode is used in the case of high frequency bursts, or where the use of AC coupling would shift the effective trigger level.

Trigger Adjustment (Delay, Level and Slope)

TRIGGER DELAY knob (40)– is used to adjust the amount of pre- or post-trigger delay desired when recording signals. Turning this knob slowly allows fine adjustment of the trigger point; turning it quickly results in rapid trigger point movement. Note that the value of the trigger delay applies to all the trigger sources.

Pretrigger adjustment up to 100% full scale, in steps of 0.2% is available. The value is displayed in % in the Panel Status display (press button (2) in the Main menu) and indicated on the grid by the position of an upward pointing arrow ↑ in the Trigger Delay field (IV).

Post-trigger adjustment is possible up to 10,000 divisions in 0.02 division increments. A post-trigger delay is indicated by a leftward-pointing arrow, ←, in the left-hand corner of the Trigger Delay field (IV). The exact delay in seconds is specified beside this arrow.

ZERO button (41)– The **Zero** function resets the trigger delay from previously set positions to the farthest left grid line (i.e. 0.0% Pretrigger position).

TRIGGER LEVEL knob (42)– adjusts the required voltage level of a signal which is being used to generate a trigger. The level can be adjusted independently for each trigger source. Note that the trigger level is specified in volts and is normally unchanged when the vertical gain or offset is modified.

The range of trigger levels is as follows:

± 5 screen divisions – with **Chan 1**, **Chan 2** or **Chan 4** as trigger source.

None with **Line** as trigger source (zero-crossing is used).

± 2% with **EXT** as trigger source for the 9424E.

SLOPE button (34)– Selects the signal edge used to activate the trigger circuit. The slope of the trigger can be adjusted for each individual trigger source and is indicated by LEDs.

Pos- Requires a positive-going edge of the trigger signal.
Neg- Requires a negative-going edge.

Trigger Mode

TRIGGER MODE buttons (31)- Select the mode of trigger operation as follows:

SINGLE (HOLD)- Selected using the lower button (31).

In this mode, the oscilloscope digitizes continuously until a valid trigger is received. When the waveform has been acquired and displayed, no further signals can be acquired until the **Single (Hold)** button has been pressed again to re-arm the trigger circuit for the next trigger signal. This type of acquisition provides a standard means of recording a wide variety of transient events. If a trigger does not occur and the **Single** button is pressed, the oscilloscope returns to its triggered state and displays the last valid waveforms.

When the oscilloscope is in the Random Interleaved Sampling (RIS) mode, a sufficient number of triggers are acquired to complete waveform reconstruction, after which the waveform is displayed. No further signals can be acquired until the **Single (Hold)** button has been pressed again. If the **Single (Hold)** button is pressed while a RIS waveform is being acquired, the acquisition is halted and partial waveform reconstruction is performed.

When the oscilloscope is in the Roll mode (≥ 500 msec/div), pressing the **Single (Hold)** button causes data acquisition to stop immediately and the display to freeze. The acquisition can be continued by pressing the button again.

NORM- Selected using buttons (31).

When in the normal (**Norm**) trigger mode, the oscilloscope continuously digitizes the input signal. Whenever a valid trigger is received, the acquired waveform is displayed on the screen, digitization recommences and the trigger circuit is re-armed. If no subsequent trigger is received within 2 seconds, the warning

"NO or SLOW TRIGGER"

is displayed in the Message field (IX). Because the oscilloscope features non-volatile front-end memory, the last waveform acquired is always stored and displayed.

When the time base is in the RIS mode, a sufficient number of valid triggers (typically between 70 and 520) is required for each display of a complete waveform.

In the Roll mode (≥ 500 msec/div), the oscilloscope samples the input signals continuously. The display is rapidly updated using newly acquired data points which results in the trace moving from right to left in a manner similar to that produced by a strip-chart recorder. After the trigger has been received, the acquisition will be completed and the display will pause while showing the acquired waveform. After a moment it will go back into the roll mode while it waits for the next trigger. The acquisition can be halted at any time by pressing the **Single (Hold)** button (31).

AUTO- Selected using buttons (31).

This mode resembles the **Norm** mode, except that it automatically generates an internal trigger whenever the selected trigger is missing for more than 500 msec, and forces a waveform to be displayed. When the oscilloscope auto-triggers, the display usually moves in time, since the trigger is not time-correlated with the input signal.

Auto-trigger in the **RIS** mode will force the display of the acquired waveform every quarter of a second even if the reconstruction is incomplete.

When the unit is in the **Roll** mode (≥ 500 msec/div), it samples input signals continuously. In the **Auto** mode this continues indefinitely. The only way to stop the acquisition is to change the trigger mode.

SEQNCE- Selected using top button (31).

Sequence triggering enables the user to partition the acquisition memories into 2, 5, 10, 20, 50, 100, or 200 segments. Waveform acquisition in the **Seqnce** mode is particularly useful in the case of short-lived or echoed signals, such as those typically encountered in Radar, Sonar, Lidar and NMR.

In the **Seqnce** mode the time base setting determines the total duration (time/div \times 10) of each segment. As can be seen from Table 2, changing the number of required segments does not change the time base; it only affects the number of digitized points (record length) per segment. The number of data points per segment is shown in the Panel Status menu.

No. of Segments	Pts/Segment 20 msec/div	Pts/Segment Maximum
2	20000	20000
5	8000	10000
10	4000	5000
20	2000	2000
50	800	1000
100	400	500
200	200	200

Sequence Trigger Mode: Number of Segments vs. Record Length (Time Base 20 msec/div). The Number of Points/Segment is Time-base Dependent

Table 2

The display is updated only after all the individual segments have been acquired. If less than the required number of triggers is available, the sequence acquisition may be prematurely terminated by pressing the **Seqnce** button (31) again.

To rearm the oscilloscope to capture a second group of sequentially stored waveforms simply press the **Seqnce** button again.

The trace display is updated when the oscilloscope has terminated an acquisition in the **Single** or **Seqnce** trigger mode, i.e. no further data are acquired. Vertical positioning of the displayed trace may still be modified via the **Offset** control (39), and the **Var** vernier (38) also remains active. However, no other parameter modifications, such as vertical sensitivity, trigger or time-base changes, will alter the display of a currently acquired waveform.

When the is in **Single** or **Seqnce** mode and has finished acquiring data, all the parameters may be modified by manipulating the appropriate front-panel controls, but such modification – indicated by parameter changes in the Abridged Front Panel Status field (VII) – will only be taken into account when the next trace is being acquired.

Whenever the oscilloscope is in the **Norm** or **Auto** trigger modes, data are continuously acquired and a display is rapidly generated. Adjustment of the front-panel controls will cause prompt changes in the acquisition parameters and immediate waveform acquisition with the new settings.

Trigger Status

TRIGGER STATUS, TRIG'D and **READY** LEDs (located to the left of the **Zero** button (41))– The **Trig'd** LED indicates that an acquisition has been completed (normally after a valid trigger).

The **Ready** LED indicates that the trigger circuit has been armed and that the oscilloscope is currently digitizing input signals. When it receives a valid trigger signal, it will continue digitization until the other trigger conditions, such as trigger delay, have been satisfied and will then display the acquired waveform.

In RIS, at slow trigger rates, the trigger LED lights up each time an intermediate acquisition occurs. This feature helps to monitor the behavior of the waveform even before the waveform is reconstructed.

Trigger Symbols

To allow immediate recognition of the current trigger conditions, the oscilloscope displays a special set of trigger graphics, which appear in the **Front Panel Status** field (VII). Some examples of the standard trigger symbols are given in Figure 8. An extended set of symbols for the SMART trigger may be found in Section 6.

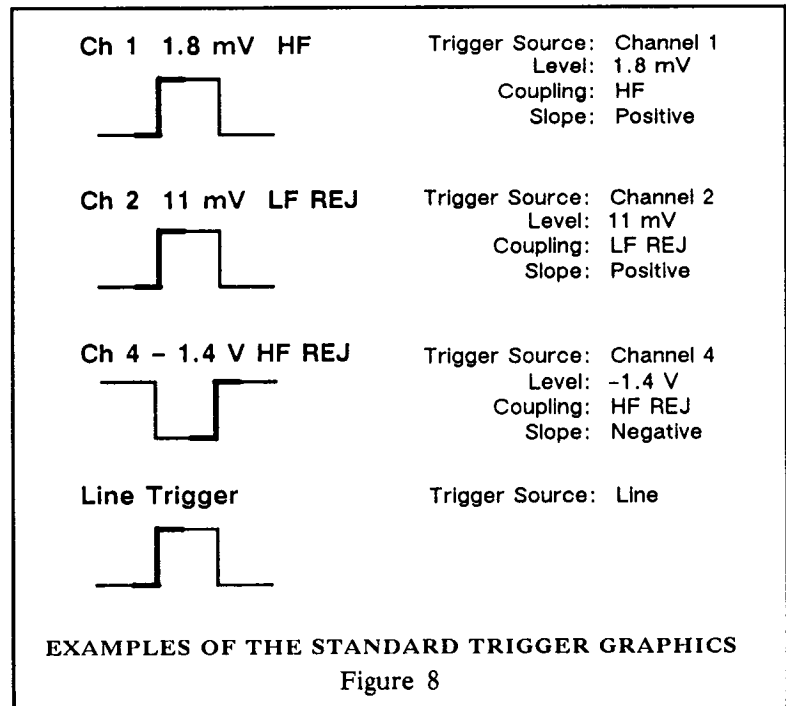

DISPLAYING TRACES

Up to four different waveforms (out of a total of ten) may be simultaneously displayed. To display a waveform, press the corresponding **Trace On/Off** buttons ((56) through (60)). The waveform will then appear on the screen together with a short description in the **Displayed Trace** field (VIII). When several signals are displayed simultaneously, buttons (56) – (60) can also be used as convenient trace identifiers. Pressing one of these buttons will turn the selected trace off and on again.

EXPAND A, B buttons (56)– Turn the displayed expansion of a waveform ON or OFF. The expanded portion of a waveform is shown on the source trace as an intensified region. The default settings are; **Expand A** which operates on **Channel 1**, and **Expand B** which operates on **Channel 2**. The default settings may be modified to allow expansion of any other source trace by using the **Redefine** button (51), and choosing the required source to expand using the menu buttons (2) through (9).

FUNCTIONS (MEMORY) C, D buttons (57) – Turn the display of a waveform stored in Function C or D ON or OFF. Data from any of the waveform storage locations, Channels 1, 2, 3 and 4, **Expand A** and **B** and **Functions E** and **F** may be stored into these memories by pressing the **Store** button (1). **Functions C** and **D** can also be used for waveform processing and waveform expansion. Use the **Redefine** button (51) to select the type of computation.

FUNCTION E, F buttons (58)– Turn the display of a computed or stored waveform ON or OFF. **Functions E** and **F** can be used for waveform processing or as memories, as explained for **Functions C** and **D** above. The type of computation may be defined by pressing the **Redefine** button (51)

CHANNELS 1, 2, 3 and 4 buttons (59) and (60) – Turn the display of signals applied to the input connectors (23), (25), (28) and (30) ON or OFF. Data are always recorded simultaneously into the acquisition memories, irrespective of whether the trace displays are ON or OFF. Each time a trace is turned on, the corresponding LED in **Channel Select** will light up as if button (24) had been pressed.

DISPLAY CONTROL AND EXPANSION

Before waveform acquisition the traces are controlled by the **Vertical** and **Time/Division** controls ((37), (38), (39), and (44), (45), respectively).

Displayed traces may be modified within certain limits following waveform acquisition.

Expand A, B (56), **Function C, D** (57), and **Function E, F** (58), are controlled by the **Display Control** knobs and buttons (49) through (54). Only one trace can be controlled at a time. The

identity of the controlled trace is indicated by a rectangular frame around the waveform descriptor in the Displayed Trace field (VIII).

Whenever more than one of the six traces listed above is currently displayed, the frame may be moved to the next trace by pressing the **Select** button (55).

HORIZONTAL POSITION knob (49)– Horizontally positions an expanded waveform and the intensified region along the source trace. This control is activated only after the **Expand A** and/or **B** buttons (56) (or **Functions C** and/or **D** buttons (57) when they are defined as expansions) have been pressed to display the expanded trace. The **Horizontal Position** knob allows the user to scroll continuously through a displayed waveform.

When the waveform source is a sequence waveform, two additional options appear in the root menu. They can be used to change between segments of a sequence acquisition while keeping a constant expansion factor and position. If the buttons are pressed continuously, the display will rapidly move from one segment to the next. This capability can also be used with the multi-zoom feature.

VERTICAL POSITION knob (50)– Vertically repositions the selected trace.

RESET button (52) – Resets any previously adjusted **Vert Gain**, **Vertical** and/or **Horizontal Position** settings to the following default values:

Vert Gain – Same as the original trace.

Vertical Position – Same as the original trace.

Horizontal Position – Center of the original trace.

In the multi-zoom expansion mode (see below), this button is used to synchronize the intensified regions of **Expand A** and **B** and **Function C** and **D**.

VERT GAIN knob (53)– Turning the knob clockwise allows vertical expansion by a factor of up to 5. Counterclockwise rotation allows vertical contraction by a factor of up to 5. When operating on processed waveforms the maximum **Vert Gain** magnification may be increased from 5 up to 50.

Pressing **Reset** button (52) returns gain control to a mid-range plateau corresponding to a gain of 1.

TIME MAGNIFIER knob (54)– This control horizontally expands waveforms by a factor of up to 1000 and operates on **Expand A and B** and **Functions C and D** only.

Overall timing accuracy and resolution is improved at higher magnification factors. The expand function is controlled digitally and makes use of the oscilloscope's high number of recorded data points. Dot-linear graphics are used for the display of highly expanded waveforms. This technique highlights the position of actual data points, allowing them to be easily identified, and connects the data using linear interpolation.

SELECT button (55)– Chooses one of the traces – **Expand A** through **Function F** – to be controlled via the **Display Control** knobs and buttons ((49) through (54)). The selected trace is indicated by a rectangular frame around the waveform descriptor in the **Displayed Trace field (VIII)**. Pressing the **Select** button moves the rectangle to the next displayed trace in a rolling sequence.

REDEFINE button (51) – Changes the source (**Chan 1, Chan 2, Chan 3, Chan 4, Func C, Func D, Func E or Func F**) of either **Expand A** or **B**. When either **Expand A** or **Expand B** is selected, pressing the **Redefine** button produces a menu on the left-hand side of the screen. Buttons (2) through (9) are then used to change the source signal. The default sources are **Chan 1** for **Expand A** and **Chan 2** for **Expand B**.

When either **Func C, D, E or F** is selected, pressing the **Redefine** button calls up the associated configuration menu to inspect or modify the function definition.

Multi Zoom Expansion

Independent expansion of single traces to display a magnified portion of the waveform from **Chan 1, Chan 2, Chan 3, Chan 4, Functions C, D, E or F** is discussed above. However, in certain applications, it is convenient to be able to move the intensified region along two or more different traces, or two or more regions of the same trace, simultaneously.

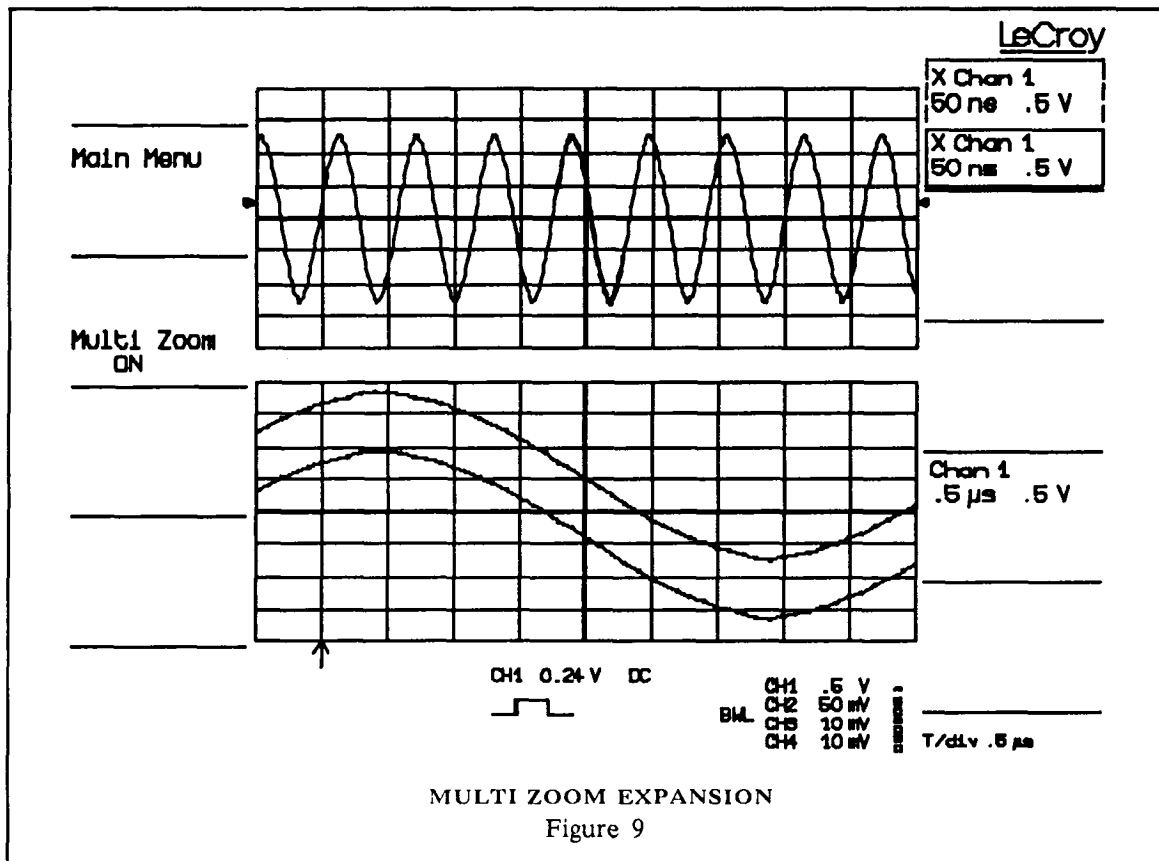

To use the "Multi Zoom" expansion facility, switch both Expand A and Expand B (or use the expand facility of Functions C and D) ON. Press the Return button (10) until the oscilloscope is in the root menu, i.e. the Main menu option appears in the Menu field (II). Beside button (5), Multi Zoom is indicated as being either ON or OFF (Figure 9). Use button (5) to set the Multi Zoom feature as required.

When Multi Zoom is ON and Expand A or B (or Function C or D) is selected with the Select button (55), the selected expand function is surrounded by the usual frame while the other expand function is surrounded by a dashed frame.

When Multi Zoom is ON, it is possible to either synchronize the intensified regions of the source signals, or to maintain a fixed time interval between them. The intensified regions will move horizontally at a fixed interval of separation. (See Section 7 for an

example of intensified regions moving on two different traces expanded in the **Multi Zoom** mode.)

In the **Multi Zoom** mode, only the **Horizontal Position** control (49) and **Time Magnifier** control (54) act simultaneously on the intensified regions of the signal source, while the **Vert Gain** control (53) and **Vertical Position** control (50) act independently on each expanded waveform.

Note that when the **Multi Zoom** mode is used, a common time magnification factor is applied to all expanded waveforms.

STANDARD WAVEFORM PROCESSING

All waveform processing occurs through **Functions C, D, E or F** and may be displayed on the screen by pressing the corresponding buttons ((57) or (58)). Whenever the **Function C, D, E or F** trace, or an expansion of one of these traces (in **Expand A, B or Function C, D**), is turned ON, the corresponding waveform processing is executed after each new acquisition.

When **Functions C, D, E and F** are displayed, their vertical display gain and the vertical position can be modified, but not the horizontal position and the time magnifier. Of course, they can be expanded by redefining the source waveform of the traces **Expand A or B**, or of **Functions C or D** when they are used as expansion waveforms.

Channels 1, 2, 3 and 4 are the only possible sources for the standard waveform processing functions. However, for oscilloscopes fitted with additional processing options (WP01 and WP02), **Expand A and B**, and **Functions C, D, E and F** may all be used as sources.

Waveform processing can take an appreciable execution time when operating on many data points. The user has the option of reducing the execution time by limiting the number of data points which are used in the computation.

The then executes the waveform processing function on the entire waveform by taking every N^{th} point, where N depends on the time base and the desired maximum number of points. The first point of such a reduced record is always the data value at address 0 (i.e. the point on the left-hand edge of the screen).

Setting Up a Waveform Processing Function

It is generally good practice to stop data acquisition while preparing new conditions for waveform processing (by setting the trigger mode to **Single Trig'd**). This is recommended because the response time might otherwise be slow, depending on the current function setup. In order to prepare **Function C, D, E or F** for new conditions, or to inspect the current setup, the trace must be turned ON using buttons (57) or (58). Select the trace for display

control with the **Select** button (55) and press **Redefine** (51). A full-page setup menu for the function appears on the screen. To return to the waveform display, press either the **Return** button (10) or the **Redefine** (51) button.

The currently selected processing function and its parameters may be modified with the soft keys (2) to (5). First select the field to be modified. The rectangular frame around parameter values indicates the currently selected field. Pressing the **Previous Field** button (2) will cause the frame to move towards the top of the list, whereas pressing the **Next Field** button (3) will cause the frame to move downwards. The **Reference** knob (48) can also be used to move the frame from one field to another. Note that the options available in each field are listed in the frame in the lower right corner of the screen.

Following field selection, the current value of the field may be modified by pressing either the **Previous Value** or **Next value** button (4) or (5) or turning the **Difference** knob (46). Since the identity of the lower fields may depend on the function chosen, the parameters should be modified from top to bottom.

The following standard waveform processing functions are available:

- Average: summed
- Arithmetic: Identity, Negation, Addition, and Subtraction

The field with the label "Currently used as:" should be set to "Compute" to activate processing functions. For Functions C and D, this field can be set to "Expand", thus allowing up to four waveforms to be examined in detail. If this field is changed to "Memory", the current contents of the trace will be remembered and no longer updated.

Available Functions

Summed Average: Summed averaging consists of the repeated addition, with equal weight, of recurrences of the source waveform. Whenever the maximum number of sweeps is reached, the averaging process stops. The averaging process may be interrupted by switching the trigger mode from **Norm** to **Single** (31) or by turning the function trace OFF (buttons (57) or (58)). Averaging will continue when these actions are reversed.

The currently accumulated average may be reset by changing an acquisition parameter, such as input gain, offset or coupling, trigger condition or time base. The number of accumulated sweeps is displayed in the Displayed Trace field (VIII) of the corresponding function or of its expansion.

After the maximum number of sweeps is reached, a larger number of sweeps may be accumulated by increasing the maximum num-

ber of sweeps in the setup menu. In this case, care must be taken to leave the other parameters unchanged, otherwise the accumulation will be restarted.

Summed averaging may be performed over Channel 1, 2, 3 or 4.

Arithmetic: Addition/subtraction consist of addition/subtraction of two source waveforms on a data point per data point basis. Different vertical gains and offsets of the two sources are automatically included in the calculation.

Negation is performed on a single source trace which is inverted.

Identity causes a waveform to be copied into one of the function memories. The number of data points can be reduced by changing the maximum number of points allowed.

SCREEN ADJUSTMENTS

INTENSITY knob (12)– Adjusts the intensity of the displayed trace and all alphanumeric readouts and messages. The **Intensity** control may be adjusted in either manual or programmed control mode.

GRID INTENSITY knob (13)– Controls grid intensity independently of displayed trace intensity.

GRIDS button (14)– Switches between single-, dual- and quad-grid patterns. The dual grid is useful when displaying multiple traces, in which case the Channel 1 and 3 displays are permanently assigned to the upper grid and the Channel 2 and 4 displays to the lower grid. The quad grid is useful for showing all four acquisition channels. In this case each channel is permanently assigned to its respective grid with Channel 1 at the top and Channel 4 at the bottom. All other displayed traces may be repositioned anywhere on the screen using the **Vertical Position** control (50).

SCREEN DUMP button (11)– Dumps the contents of the screen onto an on-line digital plotter or dot matrix printer, via the oscilloscope's rear-panel GPIB or RS-232-C interface ports, and provides color or monochrome hard copy archiving of the display. All the screen illustrations in this manual were produced using the **Screen Dump** function.

Once the **Screen Dump** button has been pressed, *all* the displayed information will be plotted. It is possible to plot waveforms without also plotting the grid by turning the **Grid Intensity** knob fully counterclockwise.

While a screen dump is taking place, as indicated by the plot graphic on the lower left-hand side of the screen, it can be aborted by pressing the **Screen Dump** button a second time. Allow some time for the plotter buffer to empty before plotting stops.

While a plotter screen dump operation is in progress new waveforms may be captured, processed and displayed. During a screen dump onto a printer, other operations are suspended.

CURSORS

Cursor measurements of absolute and relative voltage and time, may be made simultaneously on up to four traces on the oscilloscope's CRT.

The cursor system for the XY Mode is explained in the XY Mode Section.

Voltage Measurement

VOLTAGE Cursor button (16)– Used in conjunction with the **Relative/Absolute** button (18).

When **Relative** measurement is selected, two horizontal cursor bars allow accurate differential voltage measurements. The vertical position of the horizontal bars may be adjusted using the **Reference** and **Difference** controls ((48) and (46)).

Pressing the **Tracking** button (47) causes the **Difference** cursor to track the **Reference** cursor at a fixed interval as determined by the **Difference** control. A vertical bar will appear on the left edge of the grid between the reference and difference voltage bars. The length of the bar indicates the tracking interval.

When **Absolute** measurement is selected, a single horizontal cursor bar allows accurate voltage measurement with respect to the **Ground** reference level. This horizontal bar may be repositioned using the **Reference** control (48). Positioning the bar at the 0.0 V position provides an accurate representation of the reference **Ground** level.

The results of the voltage measurements for each displayed trace appear in its associated Displayed Trace Field, in place of the usual time-base and sensitivity settings.

Relative voltage cursor bars are displayed in Figure 10.

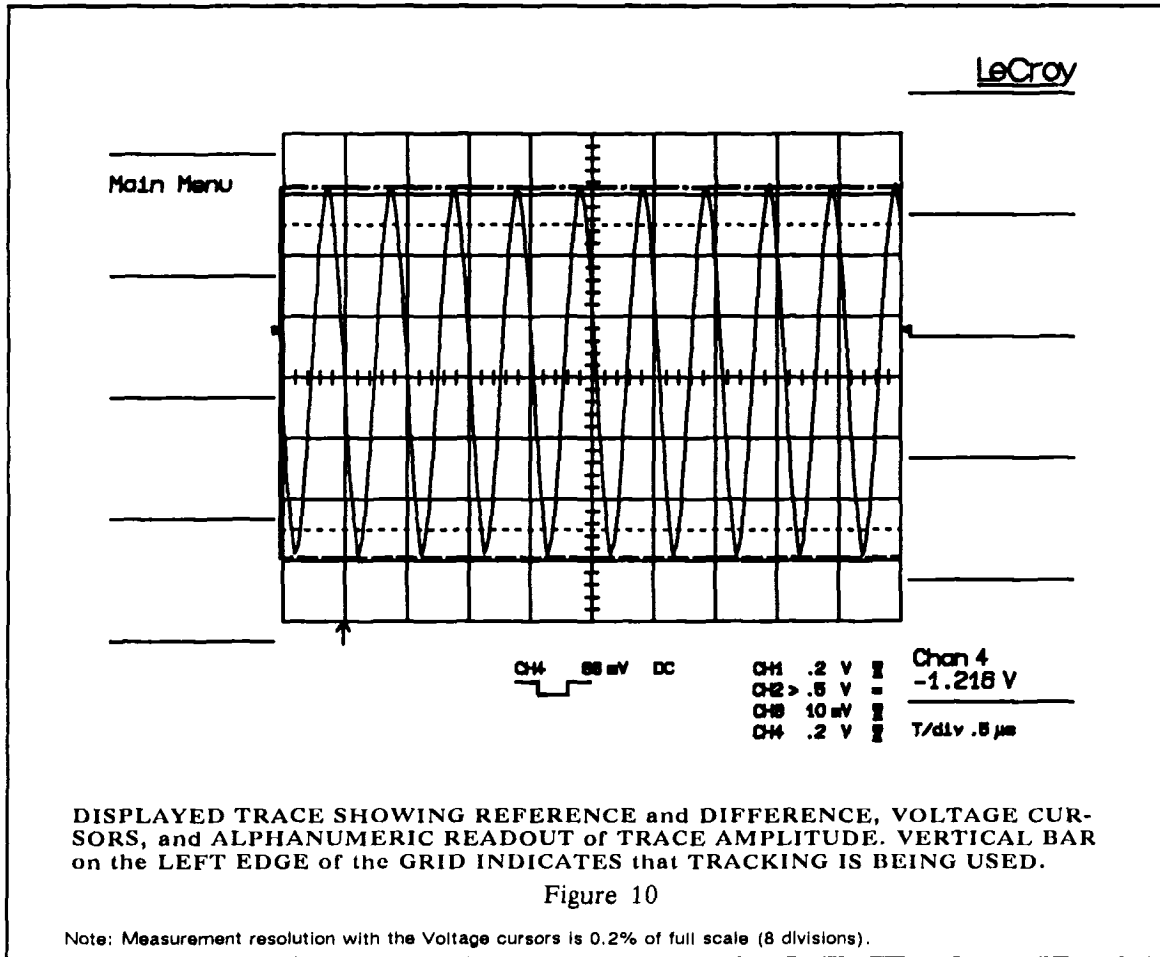

Timing Measurements

TIME Cursor button (17)– Used in conjunction with the **Relative/Absolute** button (18). When **Relative** time measurement is selected, a downward-pointing and an upward-pointing arrow appear on the currently displayed traces, permitting accurate differential time, voltage and frequency measurements. The timing arrows may be repositioned using the **Reference** control (48) for the downward-pointing arrow, and the **Difference** control (46) for the upward-pointing arrow.

Pressing the **Tracking** button (47) causes the **Difference** cursor to track the **Reference** cursor at a fixed interval as determined by the

Difference control. A horizontal bar on the top line of the grid indicates that tracking is on. Its length shows the tracking interval.

Time cursors are displayed in Figure 11.

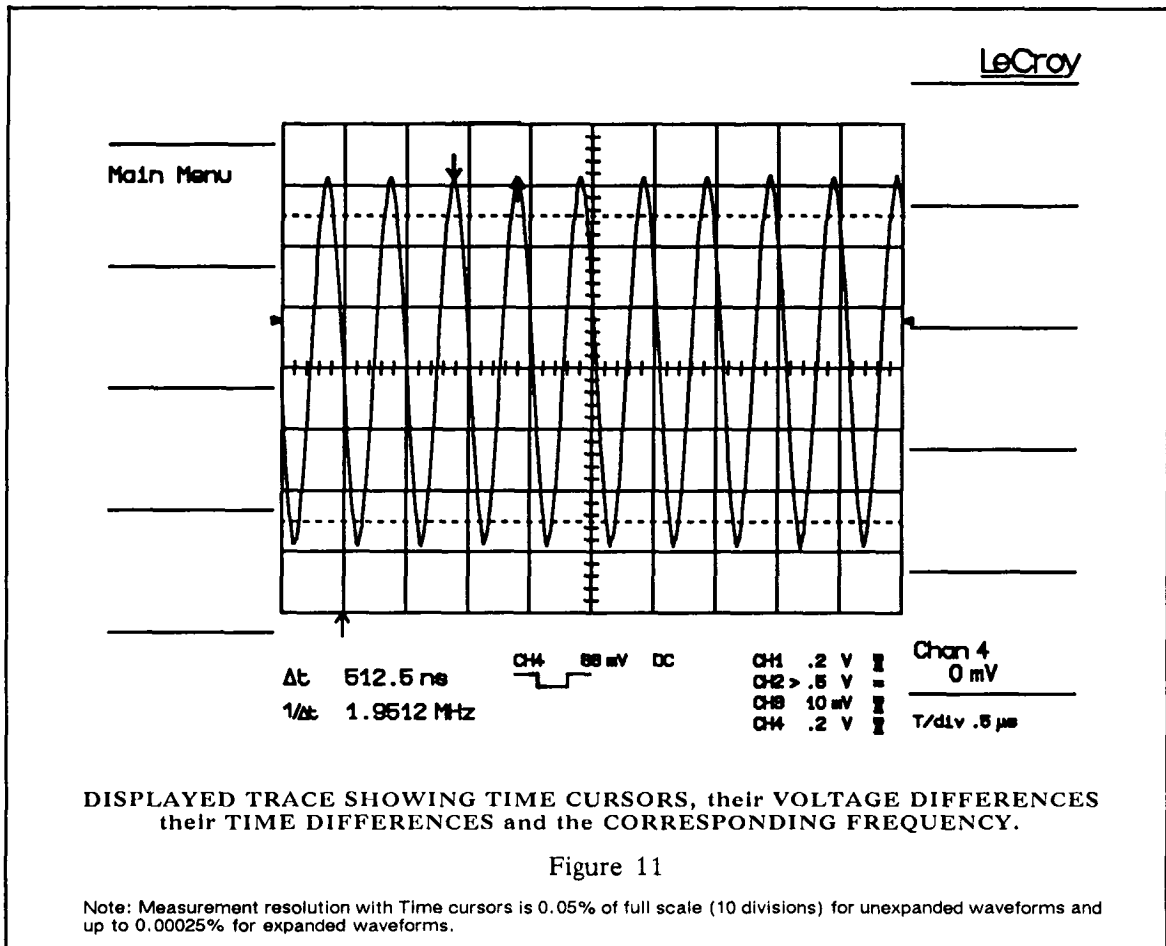

However, for expanded traces, time cursors may be positioned on the waveforms that have been magnified up to 1000 times. Higher resolution measurements, up to $\approx 10\%$ of the data point sampling interval, are therefore possible depending on the setting of the **Time Magnifier** control (54).

It is recommended to use the waveform expansion facility whenever high-accuracy time measurements are required.

When **Absolute** time measurement is selected, a cross-hair marker (+) is generated. This provides precise time measurements relative to the point of triggering, as well as absolute voltage measurements along the displayed waveform (irrespective of the vertical offset of the trace displayed on the grid). The marker is positioned on the traces with the **Reference** control (48).

When the time-base setting implies that less than 500 digitized points fill the screen, the oscilloscope interpolates, using straight line segments between actual data points. If 200 points or less are used, the digitized points are clearly visible as intensified points on the screen. When a cursor is placed on an actual data point, small horizontal bars appear on the cursor as shown in Figure 12.

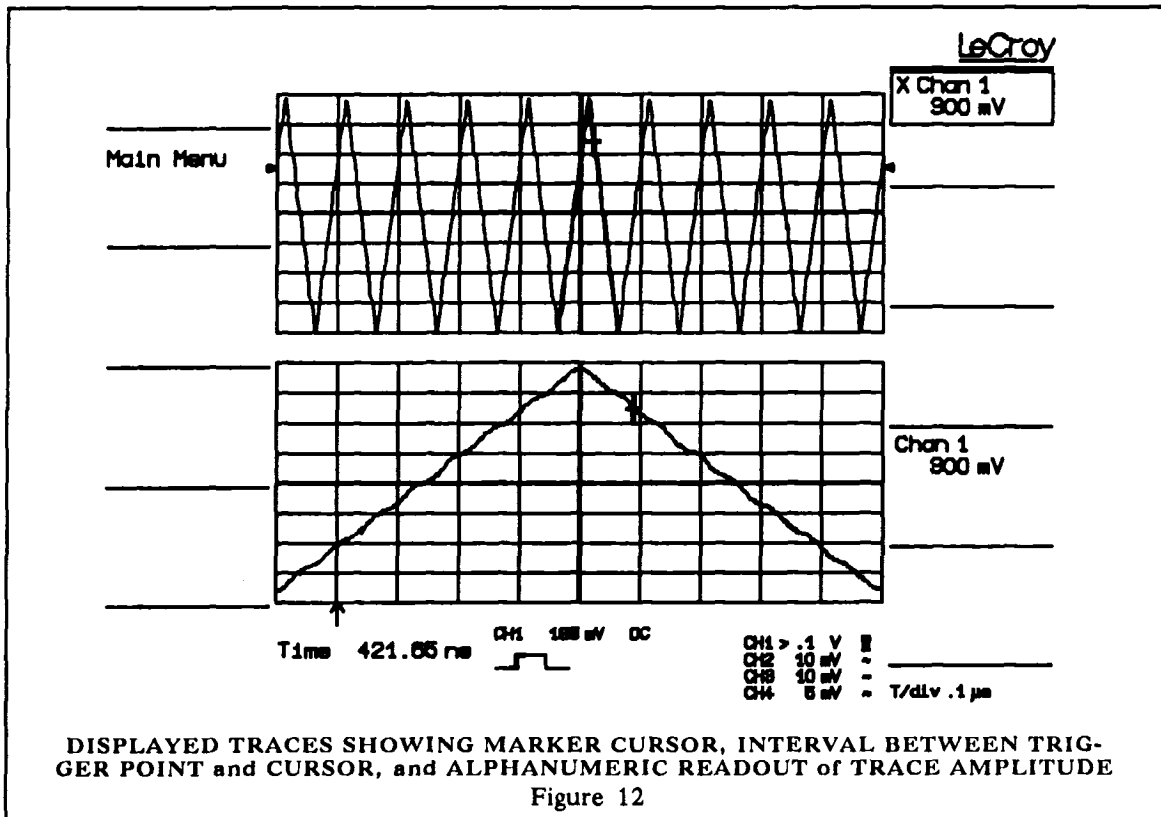

Note that setting the cross-hair marker to 0 time provides a visual indication of the trigger point. The marker is displayed as shown in Figure 12.

PULSE PARAMETERS

Pressing the **Parameters** button (15) activates the pulse parameters display mode (Figure 13). The mode allows up to ten waveform parameters to be calculated automatically on any trace, live, stored or processed. Pulse parameters cannot be calculated on waveforms acquired in sequence mode. In this case, individual segments may be viewed using the expansion capability and pulse parameters calculated on the expanded segment.

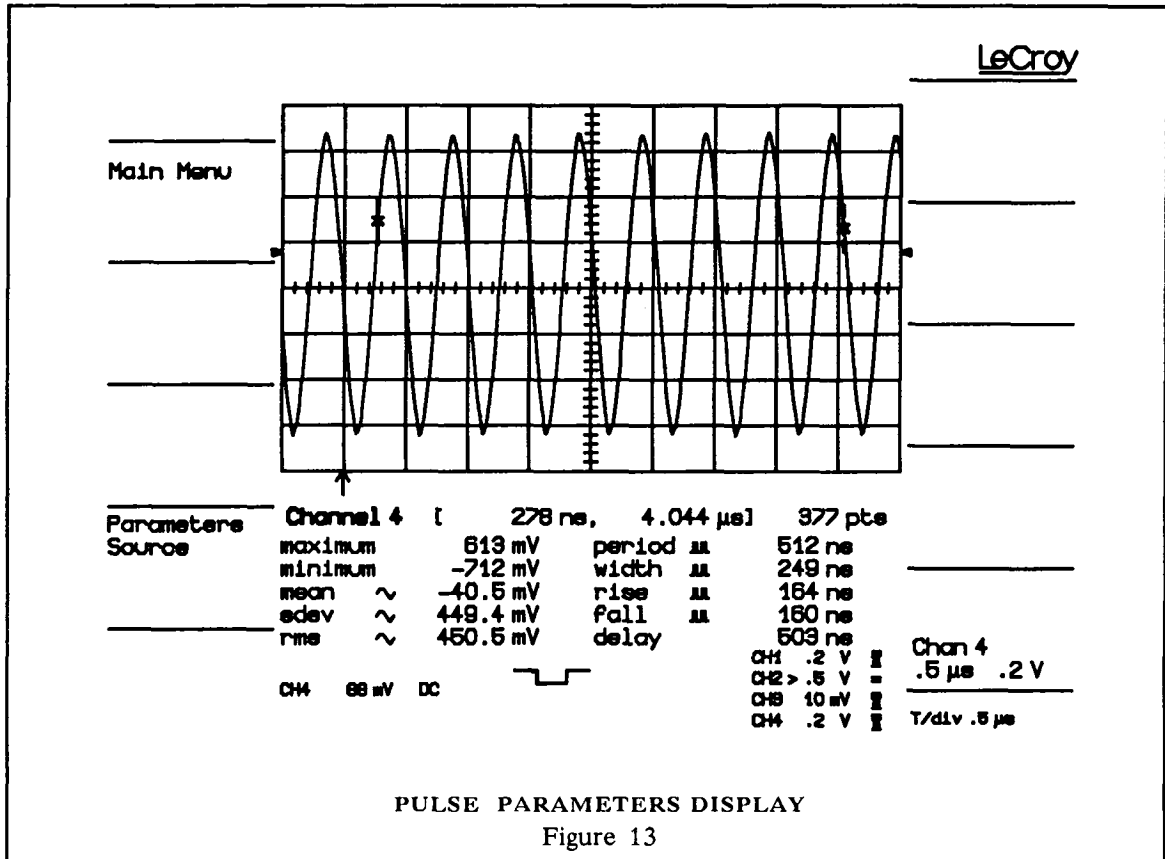

Traces are selected using the **Parameters Source** button (8) in the **Menu Field** (II) of the root menu. Pressing the **Parameters Source** button several times allows the user to scroll through the currently displayed waveforms. The selected trace is indicated in the first line of the **Parameter** field and also by a pair of cross-hair cursors which ride on the trace. Parameter measurements are based on the recommendations of IEEE Std 181-1977 "Standard on Pulse Measurement and Analysis by Objective Techniques",

and terminology is derived from ANSI/IEEE Std 194-1977 "Standard Pulse Terms and Definitions". (See Figure 14.)

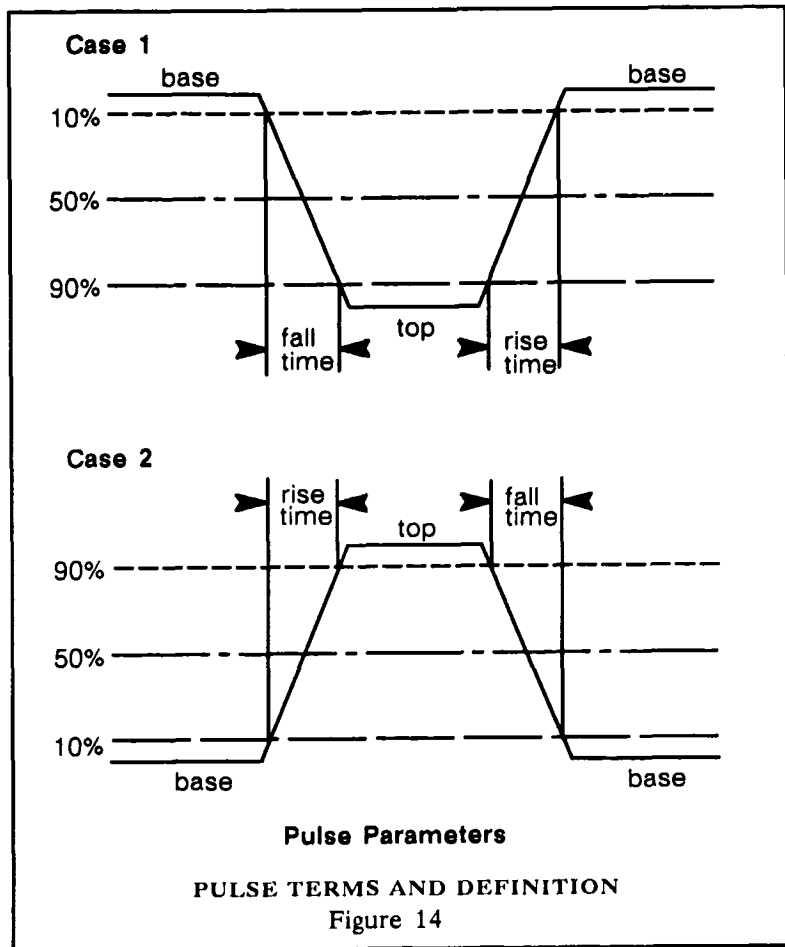

Once the **Parameters** button is pressed, a pair of cross-hair cursors appear on the currently selected waveform. Measurements may be performed on any region of interest by simply positioning the cursors, using the **Reference** and **Difference** controls (48) and (46). The cursors define the left- and right- hand boundaries of the area on which measurements will be made.

Pressing the **Tracking** button (47) causes the **Difference** cursor to track the **Reference** cursor at a fixed interval as determined by the **Difference** control. A horizontal bar on the top line of the grid indicates that tracking is on. Its length shows the tracking interval.

Precise information relating to the cursor positions (in time), and the number of data points within the region of interest, is provided in the first line of the **Parameter** field. Cursor movement is stopped at the left and right edges of the grid.

To exit the Pulse Parameters display, simply press the **Parameters** button (15) or any **Cursor Measurement** button (16) and (17).

The Waveform Parameters

The waveform parameters automatically calculated on a region of interest may be divided into two classes:

Voltage Measurements	Time Measurements
Maximum	Period
Minimum	Width
Mean	Risetime
Standard Deviation	Falltime
RMS	Delay

Voltage Measurements

In order to find magnitude reference crossings, the base and top magnitudes are assigned. The method employed follows IEEE Std 181-1977. The magnitude histogram of the waveform within the cursor window is created and searched for dominant magnitude populations. If no two dominant populations can be found, the minimum and the maximum of the distribution are used. Of the two magnitudes the lowest in the cursor window is assigned to the base line and the highest to the top line.

Maximum determines the maximum voltage within the area defined by the cursors.

Minimum determines the minimum voltage within the area defined by the cursors.

Note: In the following, v_i denotes the measured sample values. The number of data values used for computing Mean, Standard Deviation and RMS values depends on the identification of a periodic waveform. If one or more periods are identified, a sub-window is used which starts at the first mesial point (50% magnitude transition) and ends at the last mesial point on a leading edge in the original window (i.e. in the formulae below, N = the number of data points within the periods found up to a maximum of 100 periods). In all other cases, Mean, Standard Deviation and RMS are evaluated using all data points inside the cursor window.

Mean determines the average value of all the data points selected as described above.

$$\frac{1}{N} \sum_{i=1}^N v_i$$

Standard Deviation (Sdev) is the standard deviation of the measured points from the mean. It is calculated from the following formula:

$$\sqrt{\frac{1}{N-1} \sum_{i=1}^N (v_i - \text{mean})^2}$$

RMS is derived from the square root of the average of the squares of the magnitudes, for all the data as described above.

$$\sqrt{\frac{1}{N} \sum_{i=1}^N (v_i)^2}$$

Time Measurements

Note: For the time measurements it is necessary to distinguish between magnitude crossings occurring on leading edges and those occurring on trailing edges. In the equations below the following notation has been used:

$M\uparrow$ = number of leading edges found

$M\downarrow$ = number of trailing edges found

$t\uparrow_i^x$ = time when leading edge i crosses the $x\%$ level

$t\downarrow_i^x$ = time when trailing edge i crosses the $x\%$ level

All times are linearly interpolated between two measured points.

Period is calculated from the average length of the full periods of the waveform within the selected interval. A full period is the time measured between the first and third 50% crossing points, the third and fifth, the fifth and seventh, etc.

$$\frac{1}{M\uparrow - 1} \sum_{i=1}^{M\uparrow - 1} (t\uparrow_{i+1}^{50} - t\uparrow_i^{50})$$

Pulse Width (Width) determines the duration between the **Pulse Start** (mesial point, i.e. the 50% magnitude transition point, on the leading edge) and the **Pulse Stop** (mesial point on the trailing edge) of a pulse waveform. Like the pulse start, the pulse stop is a 50% magnitude reference point.

$$\frac{1}{M\downarrow} \sum_{i=1}^{M\downarrow} (t\downarrow_i^{50} - t\uparrow_i^{50})$$

Risetime (Rise) measures the time of a pulse waveform's transition with a positive slope.

Falltime (Fall) measures the time of a pulse waveform's transition with a negative slope.

For both risetime and falltime measurements the instrument determines the duration between the proximal point (10% magnitude transition) and the distal point (90% magnitude transition) on leading edges and the duration between the distal point and the proximal point on trailing edges:

leading edge duration =

$$\frac{1}{M\uparrow} \sum_{i=1}^{M\uparrow} (t\uparrow_i^{90} - t\uparrow_i^{10})$$

trailing edge duration =

$$\frac{1}{M\downarrow} \sum_{i=1}^{M\downarrow} (t\downarrow_i^{10} - t\downarrow_i^{90})$$

Depending on the sign of the slope of the leading edge transition, the instrument then assigns either

for positive slope: Risetime = leading edge duration

Falltime = trailing edge duration

for negative slope: Risetime = trailing edge duration

Falltime = leading edge duration

Delay is the time from the trigger point to the first 50% transition crossing, i.e. the **Pulse Start**.

$$t\uparrow_i^{50}$$

Information and Warning Symbols

If the number of points used is small, the statistical uncertainties in determining the base and top levels may be high and hence overall accuracy may be reduced.

The algorithm which determines the pulse waveform parameters is capable of detecting certain situations where the mathematical formulae may be applied but the results obtained must be interpreted with caution. In these cases the name of the parameter and its value are separated on the screen by a graphic symbol. The symbols and their meanings are indicated in Figure 15.

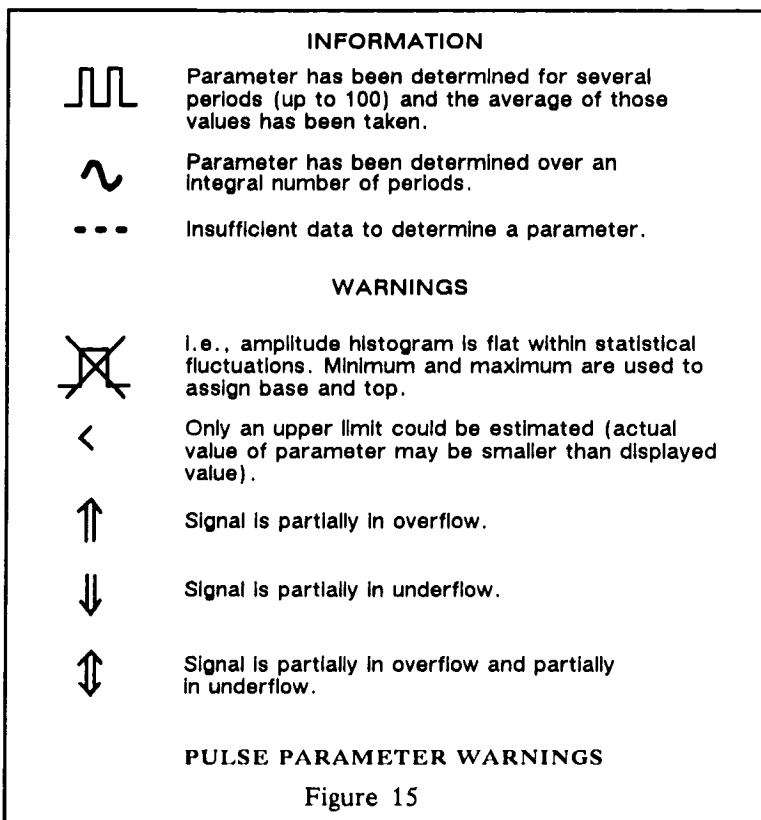

Figure 15

REMOTE CONTROL AND INTERRUPTION

When the oscilloscope is under remote control, LED (19) lights up. To return to local control, the user can press the **Local** button (19) if the instrument is not in the remote state with the lockout state selected. Full details of remote control, as well as a list of the commands, are given in the Remote Control manual.

AUTOMATIC SETUP

Pressing the **Auto Setup** button (61) automatically scales the time-base, trigger and sensitivity settings to provide a stable display of *repetitive* input signals. Signals detected must have an amplitude between 2 mV and 8 V, a frequency above 50 Hz and a duty cycle greater than 0.1%. The time taken for the auto-setup operation to be completed depends on the signal frequency, and is about 2 seconds. Auto Setup operates as follows:

- ★ Auto Setup changes neither the input coupling nor the bandwidth limit setting.
- ★ Auto Setup operates only on channels whose traces are currently turned on. The only exception occurs when no channel traces are turned ON. In that case, Auto Setup operates on all channels and turns all of the channel traces on.
- ★ If signals are detected on several channels, the lowest numbered channel with a signal determines the selection of the time base and trigger source.
- ★ If a pure DC signal is found, the trigger mode will switch to **Auto** and the time base to 10 μ sec/div.
- ★ Where the trace cannot be shown entirely, or cannot be centered, Auto Setup will indicate the cause of the problem:
 - Signal amplitude too large
 - DC component too large to show signal
 - DC component too large to center signal

MENU FIELD (II) CONTROLS

After the **Main Menu** button (2) has been pressed, any one of the oscilloscope's interactive menus may be selected by pressing buttons (2) through (10). Figure 16 shows the available menus which appear next to the adjacent menu keys. To activate a menu, simply press the button adjacent to the required menu name.

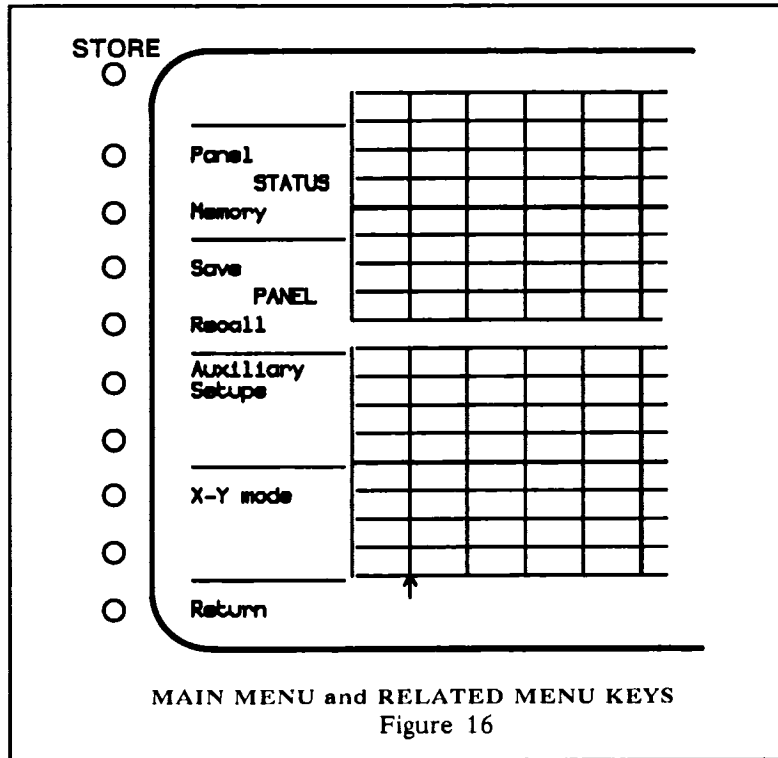

PANEL STATUS MENU

The **Panel Status** menu (Figure 17) provides the user with a complete report of the front-panel settings and permits on-screen adjustment of acquisition parameters of the currently selected channel.

Modify SMART Trigger button (2) displays the SMART trigger menu which allows the user to adjust the SMART trigger as required. Further details are given in Section 6.

Attenuator button (4) allows the user to enter probe attenuation factors of 1, 10, 100, 1000 or 10000. The **Attenuator** button operates on the currently selected channel and may be modified using **Channel Select** button (24).

Segments Modify button (6) allows the user to set the number of segments for a sequence acquisition to 2, 5, 10, 20, 50, 100 or 200.

Special Modes button (8) allows the user to access the menu for the **External Time-base Control** and the **Continuous Sequence Mode**.

Press the **Return** key (10) to return to the main menu.

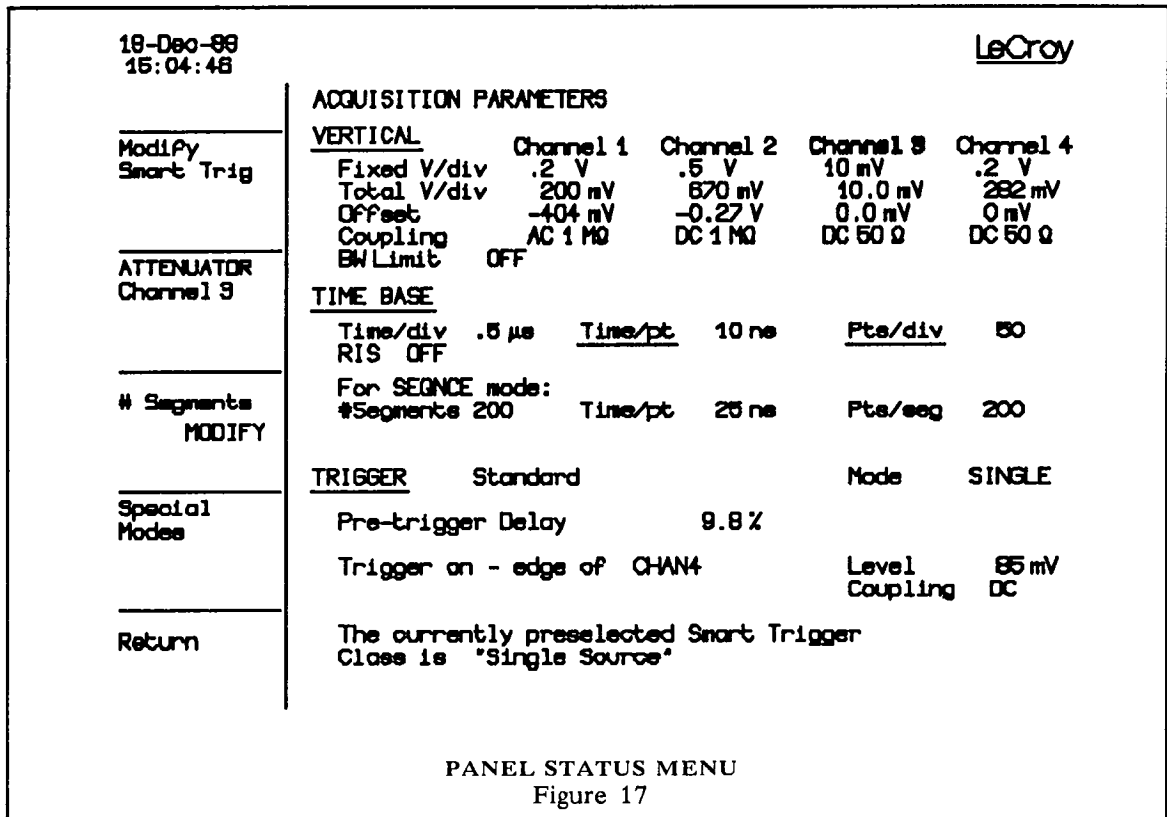

The following information is presented on the screen:

Vertical parameters

Fixed V/div indicates the current setting of the front-panel Vertical Sensitivity control (37) with the VAR vernier in the fully clockwise position.

Total V/div indicates the current setting of the front-panel Vertical Sensitivity control (37) plus the additional sensitivity range (up to $\times 2.5$ of the Fixed V/Div setting) provided by turning the VAR vernier (38) counterclockwise.

Time-base parameters

Time/point indicates the time between digitized points for the corresponding time-base setting.

Points/div indicates the number of digitized points per division on the display of any non-expanded waveform.

Segments indicates the number of segments selected for sequential acquisition. On-screen modification of this parameter is possible by pressing the **Modify # Segments** button (6) to change the indicated segment number from 2 to 200 in a rolling sequence.

If the time-base setting is faster than 50 nsec/div, a message will be displayed indicating that the interleaved and sequence modes are incompatible.

Trigger parameters

Trigger Delay is indicated as being either a pretrigger or post-trigger delay. In Figure 17 the pretrigger delay indicated is 9.8%, meaning that when in **Main Menu** the **Delay** arrow is positioned one division to the right of the left-hand edge of the grid. In the case of a post-trigger delay setting, this would be indicated in decimal fractions of a second (e.g., ← 4.00 msec).

Level- Indicates the trigger level in volts.

SMART trigger mode

The currently selected SMART trigger mode (single source, pattern, state qualified, time/events qualified, or TV) is always displayed in the **Panel Status** menu. When the SMART trigger is switched on, this will be the active configuration.

MEMORY STATUS MENU

The **Panel Status** menu displays acquisition parameters for waveforms to be acquired. The **Memory Status** menu on the other hand displays acquisition parameters for waveforms already acquired and currently stored in the various memories.

The annotation used for **Memory Status** is similar to that of the **Panel Status** menu. Pressing the **Memory Status** button (3) displays the **Memory Status** menu for Channel 1 as shown in Figure 18.

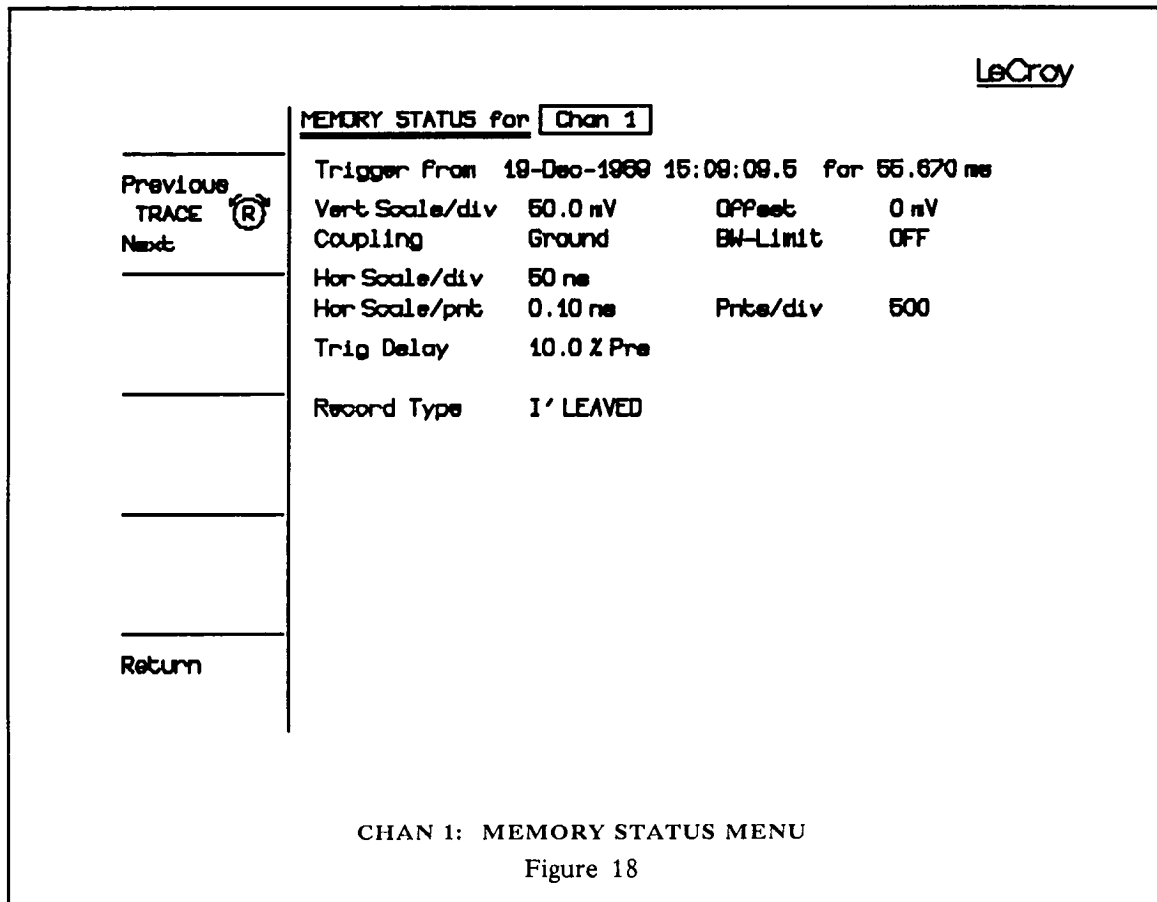

Pressing button (2) or (3) or rotating the Reference knob (48) while in the Memory Status menu will display in turn the acquisition parameters of all the waveforms stored in acquisition, expansion, storage and function memories respectively (see Figures 18 through 21).

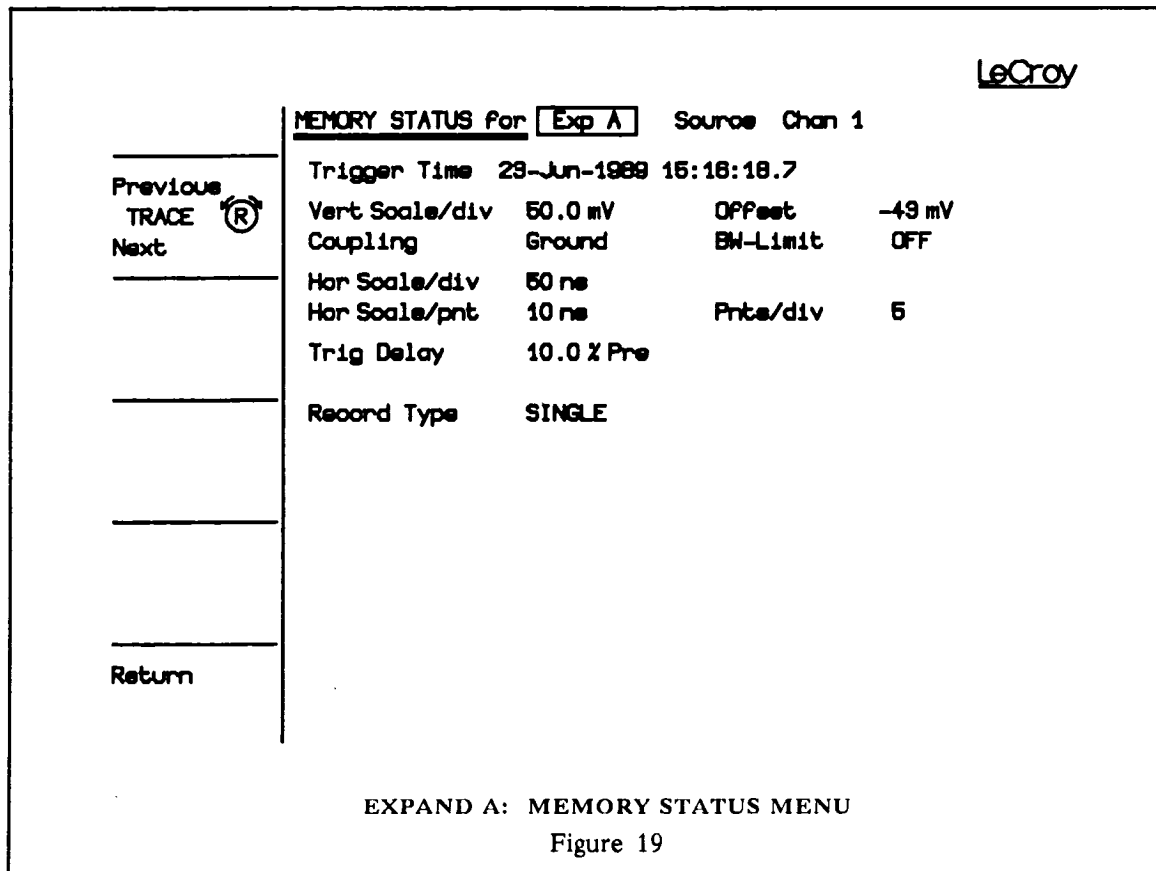

LeCroy

MEMORY STATUS For Mem C	
Previous	Trigger Time 23-Jun-1989 15:55:12.4
TRACE (R)	Vert Scale/div 50.0 mV Offset -43 mV
Next	Coupling Ground BW-Limit OFF
	Hor Scale/div 20 μ s
	Hor Scale/pnt 10 ns Pnts/div 2000
	Trig Delay 10.0 % Pre
	Record Type SINGLE
Return	

MEMORY C: MEMORY STATUS MENU
Figure 20

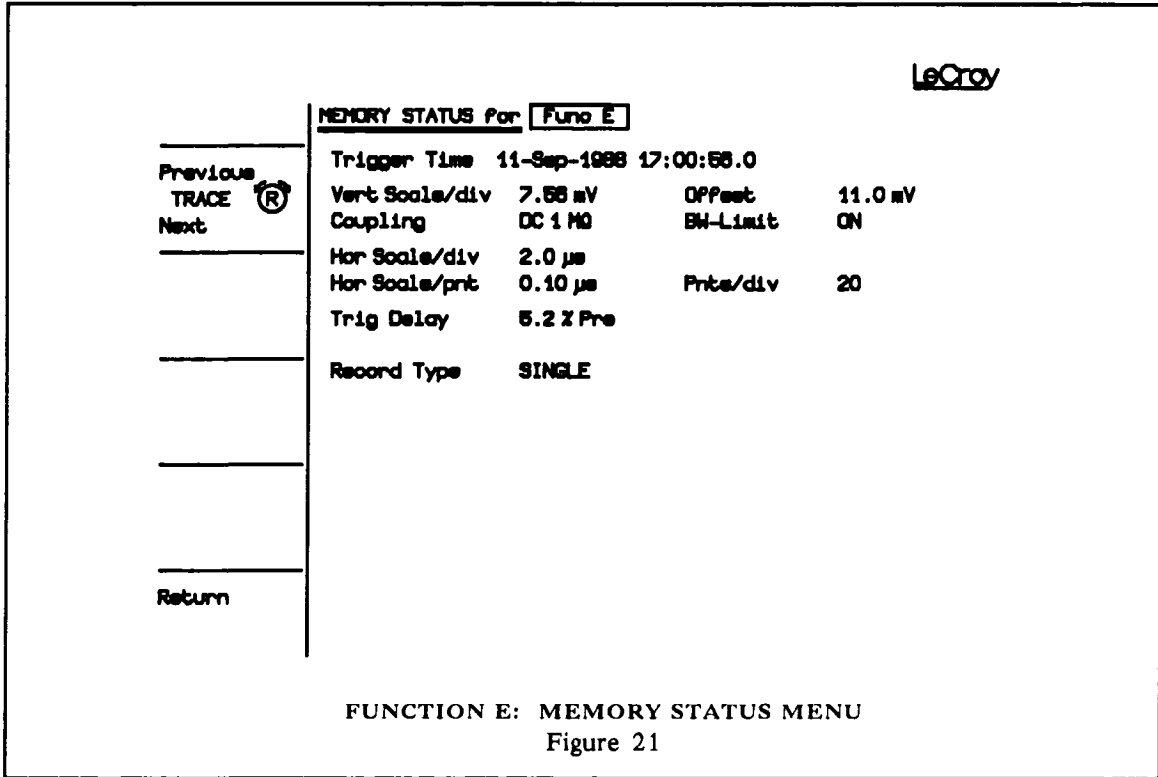

Trigger Time Stamps

A clock provides trigger time stamps for each acquisition. For single-shot applications, the trigger time is available in the Memory Status menu as shown in Figure 18. When a series of waveforms has been acquired in sequence mode, a special feature is available in the Memory Status menu as shown in Figure 22. By pressing the **Sequence Times** button (5) it is possible to obtain further information about the trigger timing (Figure 23). The sequence times of an acquisition can be displayed while the data is being acquired.

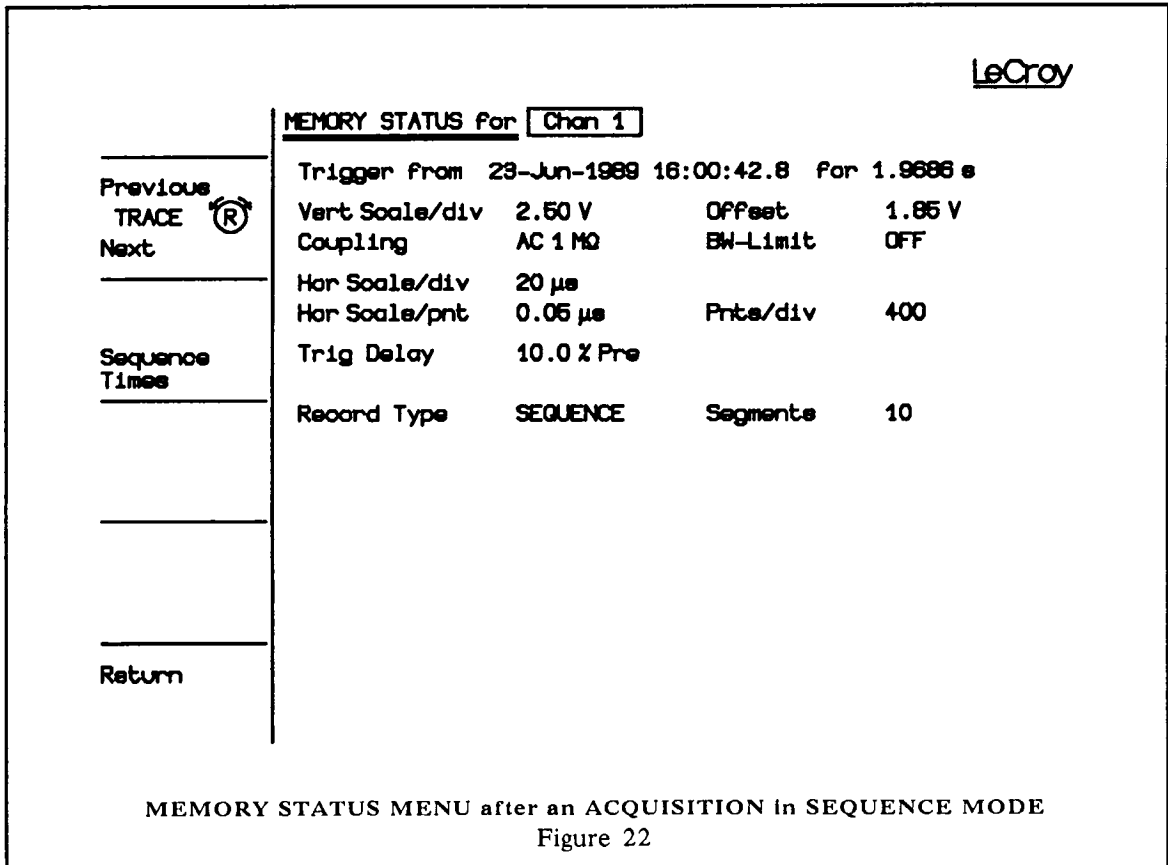

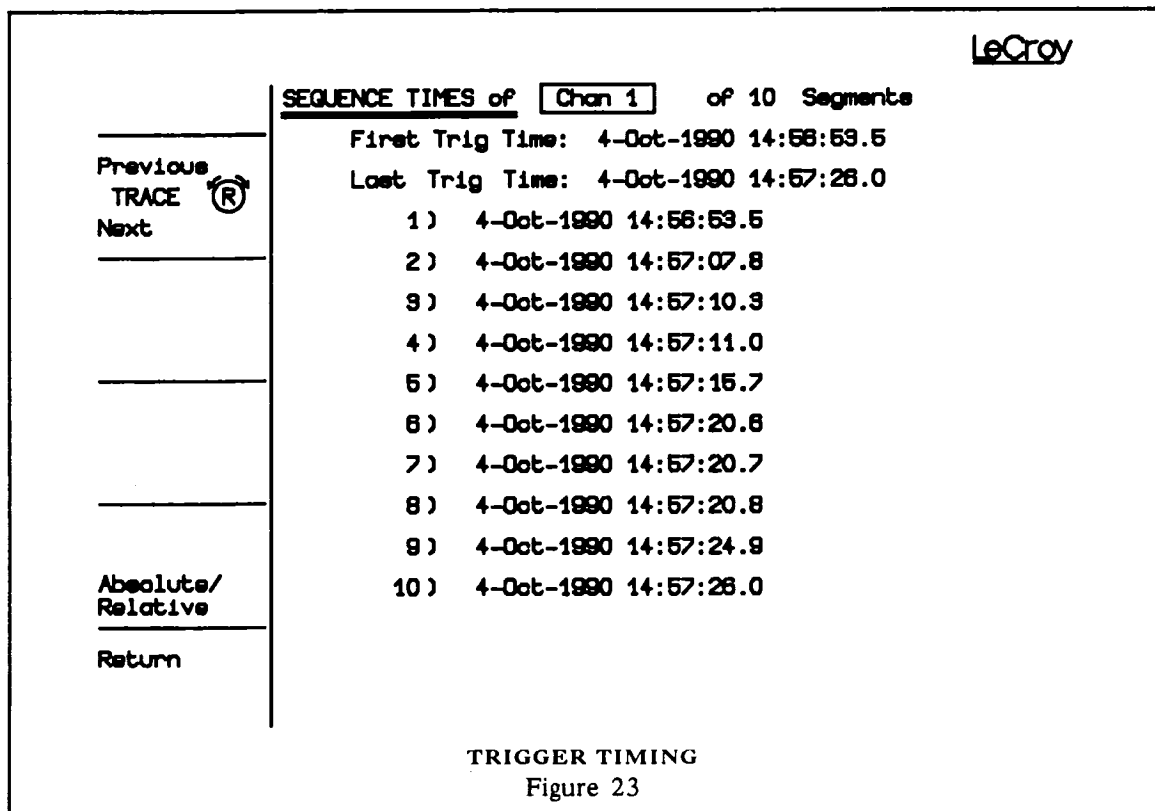

Buttons (2) and (3) and the Reference knob (48) select the required trace, Chan 1, Chan 2, Chan 3, Chan 4, Exp A, Exp B, Fun C, Fun D, Fun E or Fun F.

For sequence acquisitions with more than 10 segments, buttons (6) and (7) and the Difference knob (46) allow the user to scroll through the list of trigger times.

Pressing the Absolute/Relative button (9) displays either absolute trigger times with 0.1 sec resolution together with dates, or trigger times relative to the first trigger with 1 nsec resolution.

The sequence times of a continuous sequence mode acquisition are only available after the acquisition has been terminated.

SAVING AND RECALL OF FRONT-PANEL SETUPS

Pressing the **Save Panel** or **Recall Panel** buttons ((4) and (5) respectively) in the Main Menu enables the user to store or recall up to seven different front-panel acquisition parameter settings.

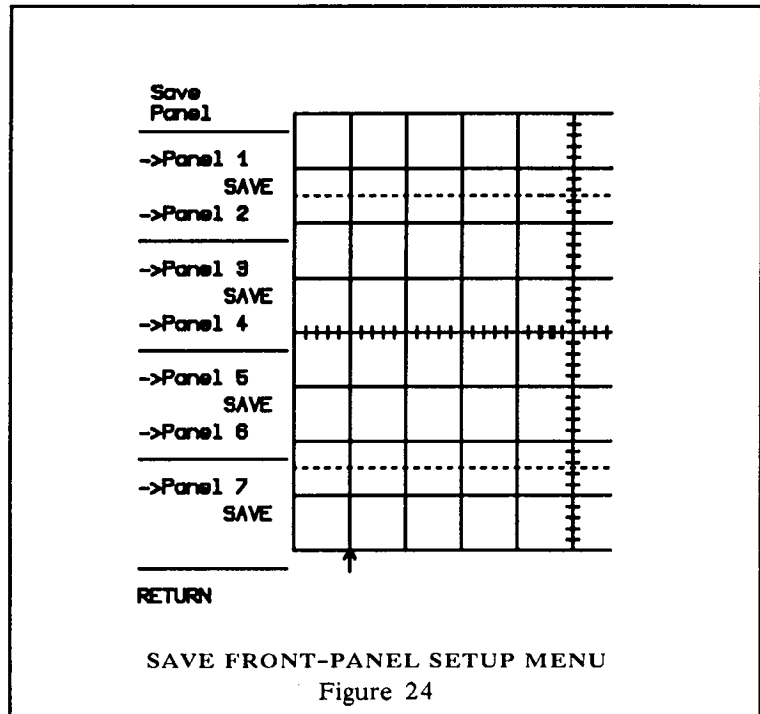

Once you have obtained a satisfactory front-panel setup, simply call the **Save Panel** menu (Figure 24) by pressing button (4); then press any one of the buttons (2) through (8) to store this front-panel setup where required. Press the **Return** button (10) to go back to the **Main** menu and continue normal oscilloscope operation.

To recall a previously stored front-panel setup, press the **Recall Panel** button (5) while in the **Main** menu. A list of up to seven stored front-panel setups will be displayed (Figure 25), together with the date and time at which they were stored. Press the button ((2) through (9)) which corresponds to the required setup, and the front-panel settings will automatically be configured according to the acquisition parameters recalled.

LeCroy

RECALL PANEL

Panel 1	From 4-Oct-1990 15:08:40
RECALL	
Panel 2	From 4-Oct-1990 15:09:00
Panel 3	From 4-Oct-1990 15:09:18
RECALL	
Panel 4	From 4-Oct-1990 15:09:26
Panel 5	From 25-Sep-1990 15:45:59
RECALL	
Panel 6	From 25-Sep-1990 15:58:15
Panel 7	From 25-Sep-1990 15:28:58
RECALL	
Default	A predefined reproducible state
RETURN	

RECALL FRONT-PANEL SETUP
Figure 25

The default setup menu, button (9), is shown in Figure 26.

NO or SLOW TRIGGER		LeCroy				
ACQUISITION PARAMETERS						
<u>VERTICAL</u>						
Modify Smart Trig		Channel 1	Channel 2	Channel 3	Channel 4	
	Fixed V/div	50 mV	50 mV	50 mV	50 mV	
	Total V/div	50.0 mV	50.0 mV	50.0 mV	50.0 mV	
	Offset	0 mV	0 mV	0 mV	0 mV	
	Coupling	AC 1 M Ω	AC 1 M Ω	AC 1 M Ω	AC 1 M Ω	
	BW Limit	OFF				
<u>ATTENUATOR</u>						
Channel 1						
<u>TIME BASE</u>						
	Time/div	50 ns	Time/pt	10 ns	Pts/div	5
	RIS	OFF				
For SEQNCE mode :						
# Segments	#Segments	5	Time/pt	10 ns	Pts/seg	50
<u>TRIGGER</u>						
	Standard			Mode	NORMAL	
Pre-trigger Delay 10.0%						
Trigger on + edge of CHAN1						
Level Coupling 0 mV AC						
The currently preselected Smart Trigger Class is "Single Source"						
Return						

FRONT-PANEL SETUP MENU of the DEFAULT SETUP
Figure 26

AUXILIARY SETUPS

To access the auxiliary setups menu (Figure 27), press button (6) in the Main menu. Information on the following is supplied for your .

- Serial number
- Software version
- Software options
- Hardware options
- GPIB and RS-232-C configuration

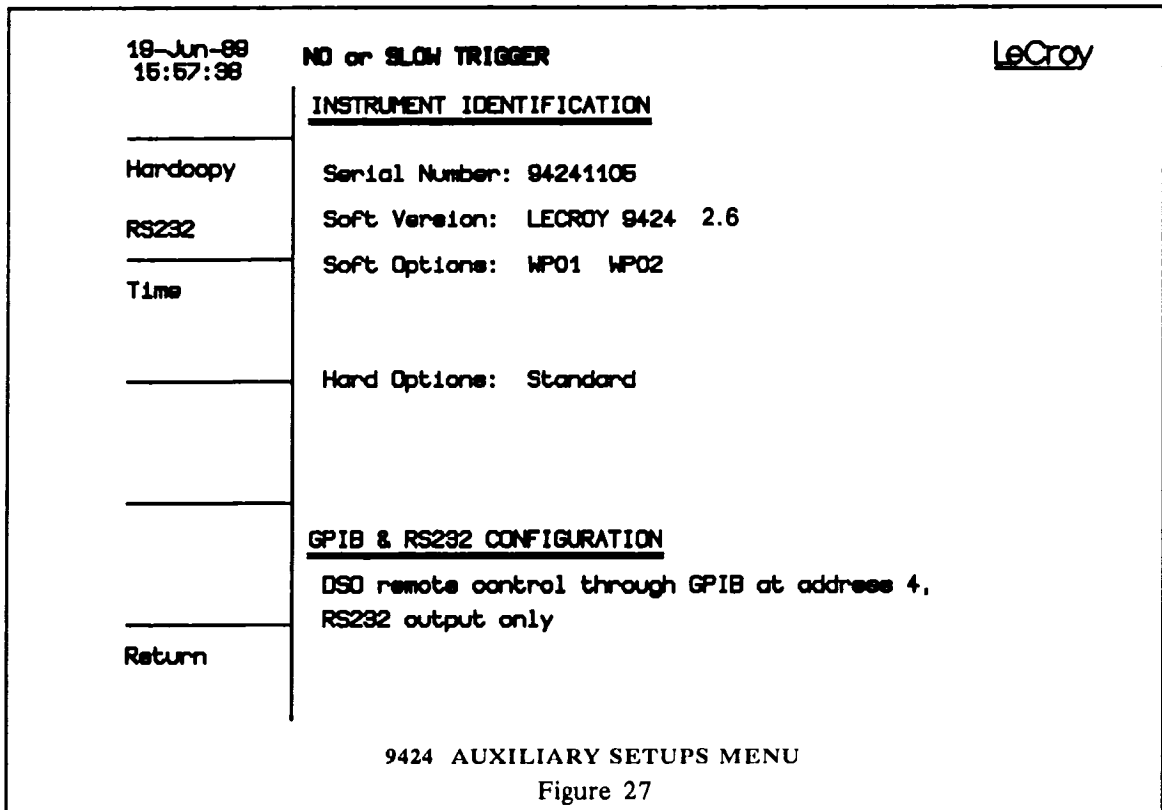

Menu buttons provide access to menus for Hardcopy, RS232, and Time (clock) control.

Hard Copy

The has been designed to enable direct interfacing of the oscilloscope via the rear-panel GPIB (IEEE-488) or RS-232-C plotter port to single- or multi-pen digital plotters, as well as HP, IBM and EPSON printers.

When the oscilloscope is connected to a plotter via the GPIB port, with no host computer in the configuration, the rear panel thumb-wheel switch must be set to the **Talk Only** mode (address ≥ 31 decimal) and the plotter to the **Listen Only** mode.

Note: Whenever the GPIB address is changed, the power must be turned off and on again.

Enter the **Hardcopy** menu (Figure 28) by pressing button (2) in the **Auxiliary Setups** menu.

NO or SLOW TRIGGER
LeCroy

HARD COPY

Previous FIELD Ⓜ

Next

Previous VALUE Ⓧ

Next

Cancel

Return

Device type: HP 7470A plotter or compatible

Hardcopy port: RS232 (must use 8 bits with printers)

Plotter speed: Normal

Number of installed pens: 4

Page feed: Off

PLOT SIZE

Paper format: Non standard

Size of the grid square [mm]: 40.0

Position of lower left corner: x[mm] +10
y[mm] +10

Plot area 625 x 448 mm²

VALUES

0.1

TO

99.9

The HARDCOPY MENU
Figure 28

Use the **Reference** knob (48) or buttons (2) and (3) to scroll through the parameters. Note that the options available for each parameter are indicated on the lower right-hand edge of the screen. Use the **Difference** knob (46) or buttons (4) and (5) to choose the required option.

Hardcopy parameters can be selected by the user as shown in the following table:

PLOTTERS		PRINTERS	
Device Type:	HP 7550A (or compatible) HP 7470A (or compatible) Graphtec FP 5301 Phillips PM8151	EPSON FX80 (or compatible) HP QuietJet (or compatible) HP ThinkJet HP LaserJet	
Hardcopy Port:	RS-232-C GPIO (IEEE-488)	RS-232-C GPIO	
Graphics Density:	-----	Two to one Single Double Hi-speed double Quadruple CRT screen One to one Hi-res CRT	
Plotter Speed:	Normal Low speed	-----	
Number of Installed Pens:	1 to 8	-----	
Page Feed:	Off On	Off On	
Plot Size:	ISO A5-US 8.5"x 5.5" ISO A4-US 8.5"x 5.5" ISO A3-US 17"x 11" Non-standard	Plot Area:	157x112 mm ² 235x168 mm ² 313x224 mm ²
Non-standard:	Size of the grid square: 1 to 99.9 mm in 0.1 mm steps Lower left corner position x [mm]: -999 to 999 mm in 1 mm steps y [mm]: -999 to 999 mm in 1 mm steps	Print Size:	ISO A5-US 8.5"x 5.5" Non-standard: Size of grid square [mm]: 1 to 99.9 mm in steps of 0.1 mm

Table 3

When the **Hardcopy** menu has been set up as required, pressing the **Screen Dump** button (11) will result in a copy of the current screen being made on the plotter or printer. Note that plots are produced in parallel with normal oscilloscope operation. It is therefore possible to record and process waveforms while hard copies are being made. Screen dumps onto a printer, however, will halt other oscilloscope operations.

RS-232-C Setup

An RS-232-C port is available on the rear panel of the for remote oscilloscope operation and data transfer, as well as convenient plotter interfacing.

In the **Auxiliary Setups** menu, **RS232**, button (3), activates the menu (Figure 29) for the configuration of the oscilloscope's RS-232-C port.

LeCroy

RS232 - Remote Control Port

Previous FIELD Ⓡ Next	Baud rate : 9600
Previous VALUE Ⓣ Next	Characters length (bits) : 8
Cancel	Parity : none
Return	Number of stop bits : 1

VALUES
110
150
200
300
600
TO
19200

RS-232-C SETUP MENU
Figure 29

To modify any of the parameters displayed, first select the field to be modified. The rectangular frame around parameter values indicates the currently selected field. Pressing the **Previous Field** button (2) will cause the frame to move towards the top of the list, whereas pressing the **Next Field** button (3) will cause the frame to move downwards. The field can also be selected by rotating the **Reference knob** (48).

When a field has been selected, the current value of the field may be modified by pressing either the **Previous** or **Next Value** button ((4) or (5)) or by rotating the **Difference knob** (46).

The Baud rate can be selected from a set of values in the range 110 through 19,200 baud. The possible settings of character length are 6, 7, and 8; parity, none, even or odd; and number of stop bits, 1 and 2.

Time Setup Menu

Enter the **Time** menu (Figure 30) by pressing **Time** button (4) in the **Auxiliary Setups** menu.

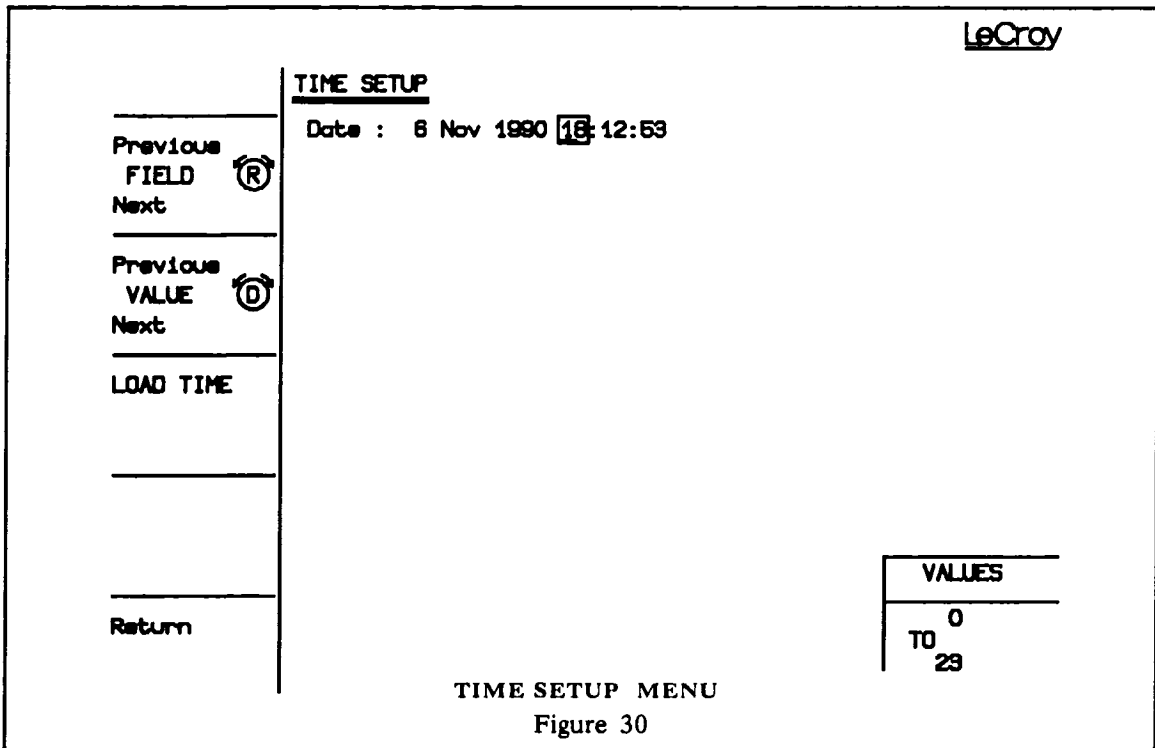

Six fields (day, month, year, hours, minutes, and seconds) are accessed using buttons (2) and (3) or the **Reference** knob (48). The settings are changed using buttons (4) and (5) or the **Difference** knob (46).

When the date and time have been set as required, press **Load Time**, button (6), and then press **Return**, button (10), to return to the Auxiliary Setups menu.

X VERSUS Y DISPLAY

The X versus Y (XY) display mode is switched on and off by pressing button (8) of the main menu. The mode allows the user to display one source (from Channel 1, Channel 2, Channel 3, Channel 4, Expand A, Expand B, Function C, Function D, Function E, Function F) against another. The technique is normally used to compare the amplitude information of two waveforms and can reveal phase and frequency information through the analysis of patterns called Lissajous figures.

The layout of the XY screen is shown in Figure 31. The square grid in the top half of the screen is used for the XY display while the rectangular grid underneath simultaneously shows the original source waveforms. The rectangular grid can also be used in a Multi Grid mode by pressing button (14).

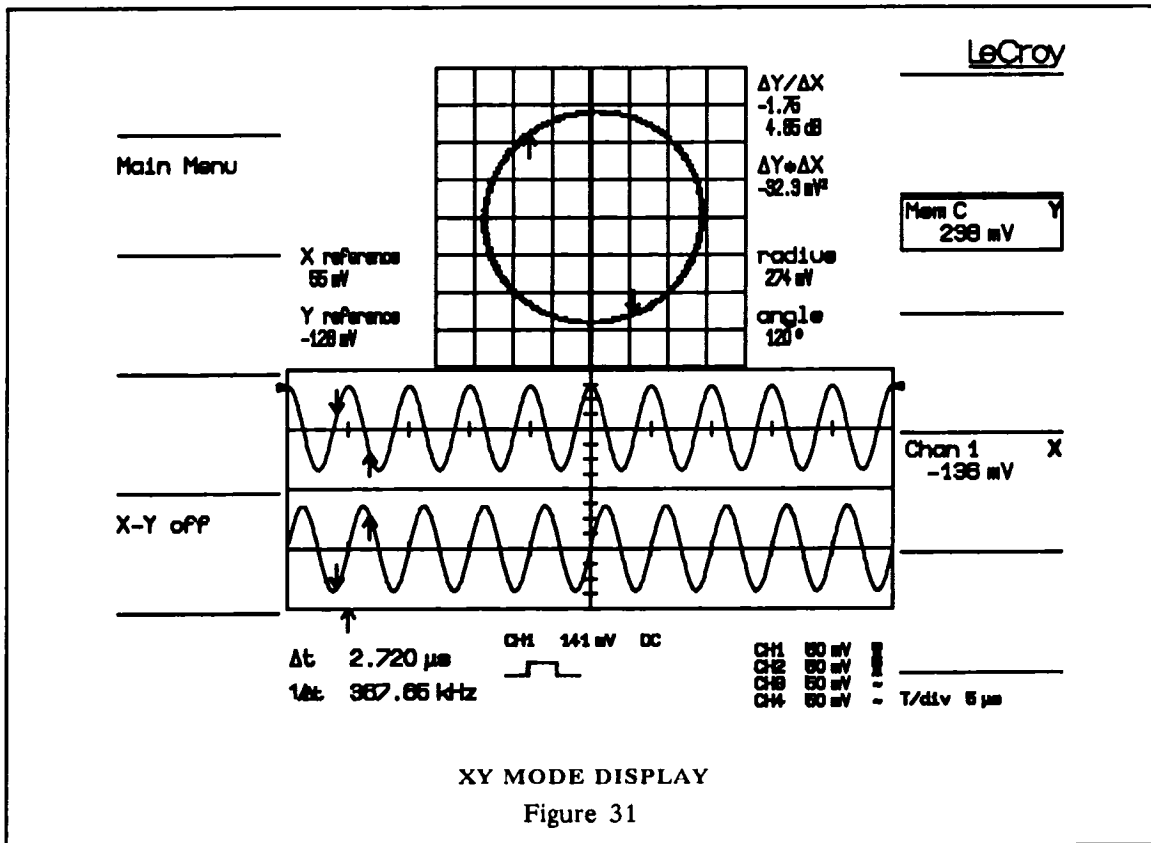

Selecting Traces for XY Display

To select the two waveforms for display in the XY mode, simply use the **Trace On/Off** buttons ((56) through (60)). The first trace selected is automatically assigned to the X (horizontal) axis of the XY display. The second trace selected is assigned to the Y (vertical) axis. Both selections are indicated at the right-hand side of the Displayed Trace field (VIII).

The XY display can be generated if the traces selected have the same time or frequency interval/point and have the same horizontal unit (second or hertz). As soon as two compatible traces have been selected, the XY display is automatically generated. If incompatible traces are selected, a warning message is displayed at the top of the screen. If two compatible traces are selected that have different trigger points (horizontal offset), then only the common part of each trace is displayed.

Cursors

As with the standard waveform display, time and voltage cursors can be used with the XY display. The time cursors are similar to those of the standard waveform display, with an additional cursor in the corresponding position on the XY display.

Cursors move on acquired or computed traces following the associated sampling interval and on the XY display on paths given by the acquisition time (Figure 31).

The voltage cursors appear on the square grid but do not appear on the rectangular grid which shows the normal time-domain waveforms. In absolute voltage mode a vertical and a horizontal bar appear on the XY display. In relative voltage mode a pair of vertical and a pair of horizontal bars appear on the XY display.

The X and Y voltage cursors may be repositioned using the **Reference** (48) and **Difference** (46) controls and the **Cursor Control** button (9) in the Menu field (II).

The voltage value of each cursor is shown below the trace title in the fields on the right-hand side of the screen. The time cursor value which is common to all traces is shown at the lower left of the screen.

Combinations of the vertical values (voltages) are shown at the right side of the square grid (see Figure 31):

- | | |
|--------------------------------|---|
| (1) The ratio | $\Delta Y \text{ value} / \Delta X \text{ value}$ |
| (2) The ratio in dB units | $20 * \log_{10}(\text{ratio})$ |
| (3) The product | $\Delta Y \text{ value} * \Delta X \text{ value}$ |
| (4) The distance to the origin | $r = \text{sqrt}(\Delta X * \Delta X + \Delta Y * \Delta Y)$ |
| (5) The angle (polar) | $\theta = \text{arc tan}(\Delta Y / \Delta X)$
range $[-180^\circ \text{ to } +180^\circ]$. |

The definition of ΔX and ΔY is dependent on the type of cursors used. The following table shows how ΔX and ΔY are defined for each type of measurement.

Cursors					
	V_{Abs}	V_{Rel}	T_{Abs}		T_{Rel}
			Org = (0,0)	Org = $V_{XOffset}$ $V_{YOffset}$	
ΔX	$V_{XRef} - 0$	$V_{XDif} - V_{XRef}$	$V_{XRef} - 0$	$V_{XRef} - V_{XOffset}$	$V_{XDif} - V_{XRef}$
ΔY	$V_{YRef} - 0$	$V_{YDif} - V_{YRef}$	$V_{YRef} - 0$	$V_{YRef} - V_{YOffset}$	$V_{YDif} - V_{YRef}$

Where

V_{Abs} = Absolute Voltage cursors

V_{Rel} = Relative Voltage cursors

T_{Abs} = Absolute Time cursors

T_{Rel} = Relative Time cursors

Org = Origin

V_{XRef} = Voltage of the reference cursor on the X trace

V_{YRef} = Voltage of the reference cursor on the Y trace

V_{XDif} = Voltage of the difference cursor on the X trace

V_{YDif} = Voltage of the difference cursor on the Y trace

Selecting the Reference Point

In order to make the polar readout of the absolute time cursor more useful, there is the possibility of choosing between two reference points. The reference is either located at point (0, 0), i.e. at X = 0 Volt and Y = 0 Volt, or at the center of the square grid. Menu button (9), active only in absolute time cursor mode, toggles the position of the reference origin between the center of the grid and (0,0).

The values of the origin are displayed on the left-hand side of the square grid. By changing the offsets of the source traces the user can center a figure on the screen and then measure angles and distances with respect to the center of the figure.

PERSISTENCE DISPLAY

The Persistence Display mode (Figure 32) is turned on by pressing button (9) in the main menu, and is turned off by either pressing button (9) again or by switching to the XY display mode in the main menu.

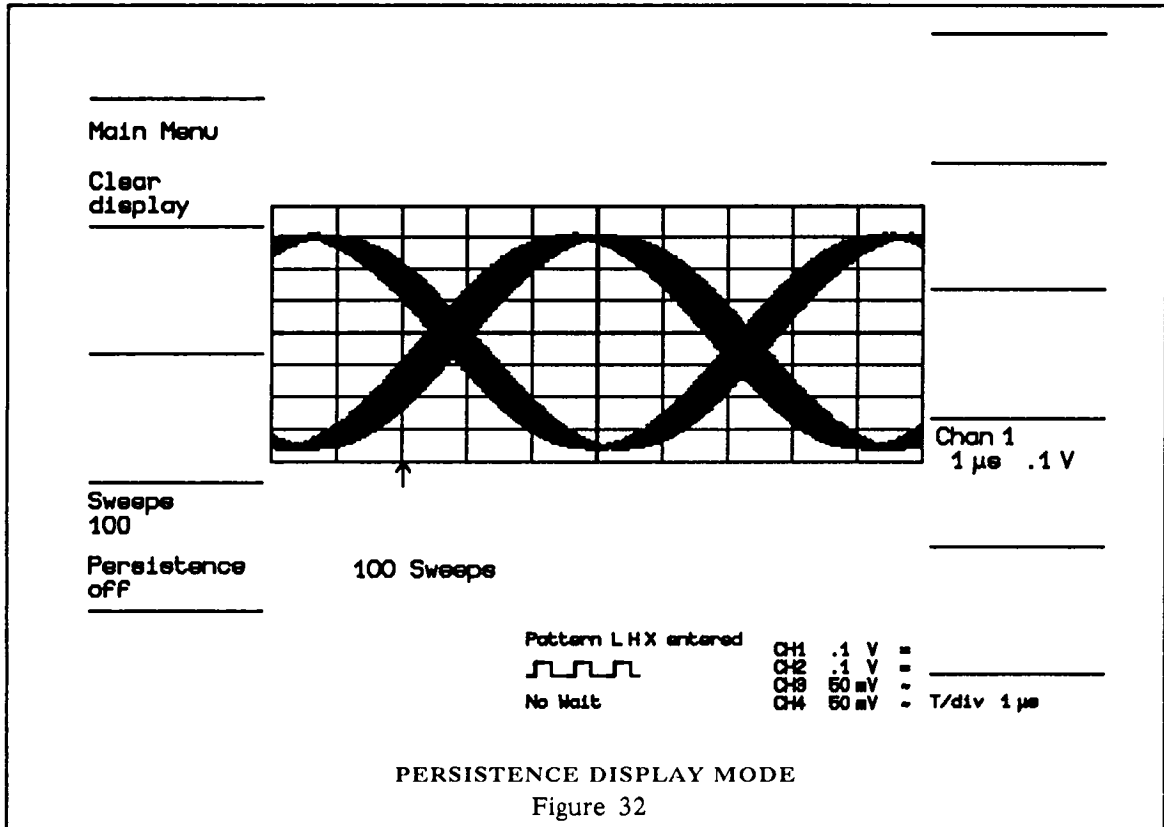

The Persistence Display mode allows the user to examine the evolution of a signal in time. A user-selectable number of successive sweeps are overlaid on the screen and the resultant display shows the variation in the signal during the sweeps. The display is updated continuously, with data older than the chosen number of sweeps being eliminated from the display. When persistence is set to INFINITE, all data is retained on the display until it is cleared by the user.

Selecting Traces

Traces are selected using the **TraceOn/Off** buttons (56) through (60).

The display can be cleared at any time by pressing **Clear Display** (button (3)), allowing a new persistence display to build up. When a displayed trace is turned off, subsequent sweeps cease to contribute and the display will gradually disappear.

The desired number of sweeps is selected by pressing **Sweeps** button (8). The options are 1, 2, 5, 10, 20, 50, 100, 200, INFINITE.

If the persistence display is turned off and on again, the original trace will be retained, provided that no further triggers are received (e.g. if the oscilloscope is triggered in Single trigger mode).

Any changes made to the acquisition conditions will cause the persistence display to be cleared and a new display will be built up.

On slow timebases (Roll Mode) there is no display update until the acquisition is complete. In some cases this can take a considerable time and it may appear as if nothing is happening.

Persistence display cannot be used in Auto Roll mode. Since there is never a completed acquisition, a display update is impossible.

In sequence mode, each segment is overlaid and the entire segmented waveform contributes as a single sweep.

When Summed Averaging, FFT Power Average, or Extrema are performed, the intermediate accumulated sweeps which are displayed at regular intervals in normal display mode, each contribute as single sweeps in persistence mode.

Cursor Measurements

Full cursor facilities are available in persistence display mode with both absolute and relative measurements supported. The time and voltage cursors are completely independent of the normal display cursors. The measurement readings appear in the Displayed Trace Field (VIII) on the right hand side of the screen.

Voltage cursors are similar to those in normal display mode. Time cursors consist of vertical bars which are placed on the desired part of the displayed waveform.

Waveform parameter measurements are not available in persistence display mode.

STORE MENU

The **Store** button (1) enables the user to store any trace in the acquisition memories into reference **Memories C, D, E or F**.

To store a waveform, press button (1) and select a source waveform on the left of the grid and a destination memory on the right. As soon as both have been selected, the operation will be performed and the menu exited. The options are shown in Figure 33.

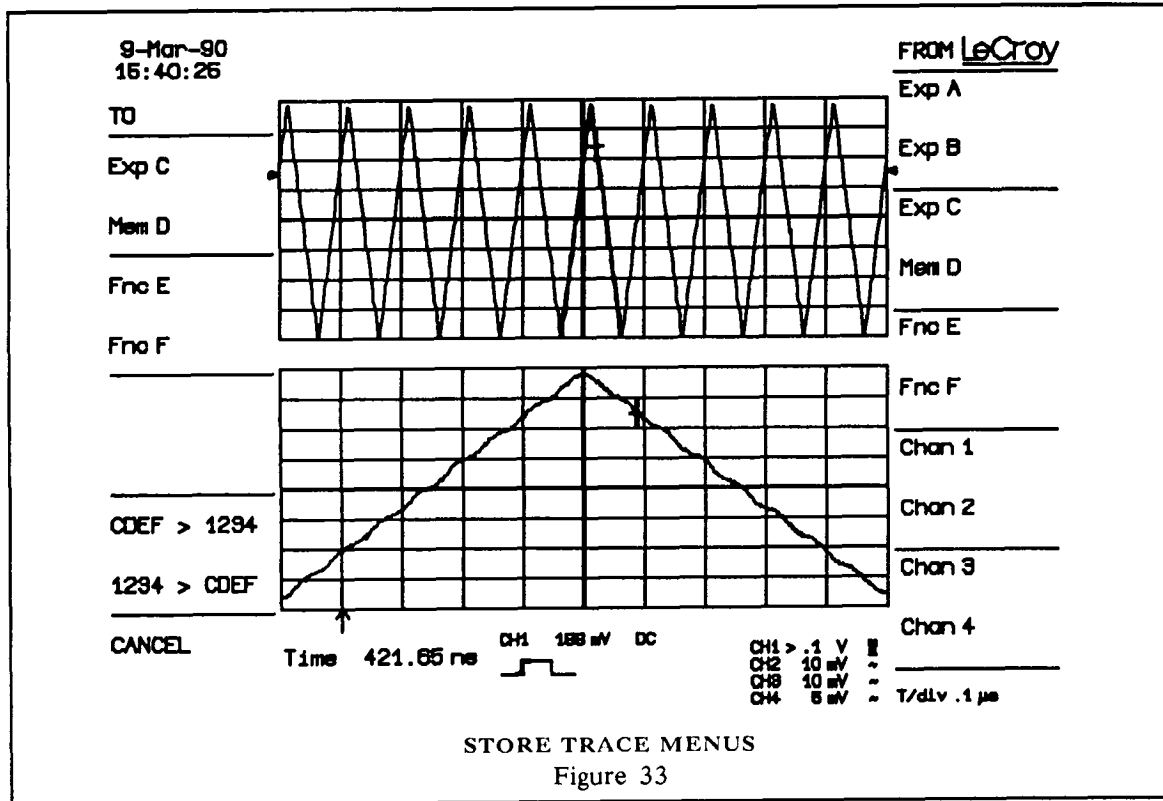



Whenever the user wishes to switch off the oscilloscope but still store data in the oscilloscope's non-volatile acquisition memories (Channels 1 to 4), the **CDEF > 1234** transfer is particularly useful. Once button (8) is pressed, data are automatically transferred from the volatile reference memories to the non-volatile acquisition memories. The oscilloscope is also switched to the single trigger mode so that further acquisitions cannot overwrite the stored data. The oscilloscope can now be safely switched off. At power ON, the contents of Channels 1 to 4 can be transferred back into Memories C, D, E and F by going into the **Store** menu

and using the 1234 > CDEF button (9). This button is also useful whenever a particular multi-trace acquisition needs to be stored in reference memory for subsequent analysis or comparison.

Note: Users should be aware that Memories C, D, E and F are volatile and will be erased when the oscilloscope is switched off. For non-volatile storage, use the CDEF > 1234 button (8) before switching off the oscilloscope.

SPECIAL MODES

The Special Modes menu (Figure 34) is entered by pressing button (8) in the Panel Status menu (Figure 17). The menu allows the user to control the External Time-base and/or the Continuous Sequence mode.

19-Jun-89 16:50:40	LeCroy		
Previous FIELD 	<u>EXTERNAL TIME BASE CONTROL</u>		
Next	External Time Base: INACTIVE		
Previous VALUE 	# of points/trace: 50K		
Next	Note: Changing the time/division knob restores normal time base behavior		
# Segments MODIFY	<u>CONTINUOUS SEQUENCE MODE</u>		
	#Segments 5	Time/pt 0.10 μ s	Pts/seg 10000
START Continuous	Note: Push button to the left to start Push MODE # button to halt		
Return	VALUES ACTIVE INACTIVE		

SPECIAL MODES MENU
Figure 34

Use the **Reference** knob (48) or buttons (2) and (3) to scroll through the parameters. Note that the options available for each parameter are indicated on the lower right-hand edge of the screen. Use the **Difference** knob (46) or buttons (4) and (5) to choose the required option.

External Time Base Control

The **External Clock Input** (62) allows users to drive the ADCs of the oscilloscope using their own clock signal. Typical applications involve the use of very high-precision clocks or clocks that provide variable or non-standard frequencies.

For the specifications of the external clock see section 7.

Operation of the **External Clock Input** is switched ON once the External Time Base has been set to **Active** in the Special Modes

menu (Figure 34). The oscilloscope will require a number of pulses (typically between 20 to 50) before it recognizes the external clock signal. Once the external clock signal has been detected, its rising edge is used to clock the ADCs of the oscilloscope. No attempt is made to measure the time difference between the trigger and the external clock. The acquisition is halted only when the trigger conditions have been satisfied and the appropriate number of data points have been accumulated. The user can select the trigger delay in the same way as for an internal time-base acquisition. As the input frequency of the external clock signal is unknown, information relating to post-trigger settings and cursors (including parameters) is expressed in samples rather than seconds.

The sequence acquisition modes can be used with the external clock. However, users should be aware that sequence time stamps are not available.

During use of an external clock, the oscilloscope's Random Interleaved Sampling mode is not available

Any adjustment to the **Time/division** knob (45) automatically returns the oscilloscope to normal (internal) clock operation. Alternatively, the External Time Base can be switched OFF by selecting **Inactive** in the Special Modes menu.

Continuous Sequence Mode

This is a special form of sequence acquisition. It continuously stores waveforms in segmented memory as long as triggers are received. Once triggering stops, the user can inspect the last N waveforms (where N is the number of segments selected in the Special Modes menu). The number of waveforms stored may be selected by pressing the **Modify # Segments** button (6). The acquisition of waveforms can only be started by using the **Start Continuous Sequence** button (9). Pressing the **Seqnce** button (31) during acquisition terminates the Continuous Sequence Mode and allows the user to view the last N waveforms.

Note: In this mode of operation, if the trigger rate is high (>500 triggers/second), the oscilloscope may appear to freeze in operation. If this happens, remove the trigger source and normal response will be restored.

Note: In the following sections, roman numerals in parentheses refer to the display field numbering scheme in Figure 2. Arabic numerals relate to the numbering scheme used to refer to front- and rear-panel controls and connectors in Figures A, B and C.

INTRODUCTION

Two levels of triggering are available in the 9424; the standard trigger and the SMART trigger. Operation of the standard trigger is covered in Section 5. There are five basic operational modes within the SMART trigger, as shown in Figure 35.

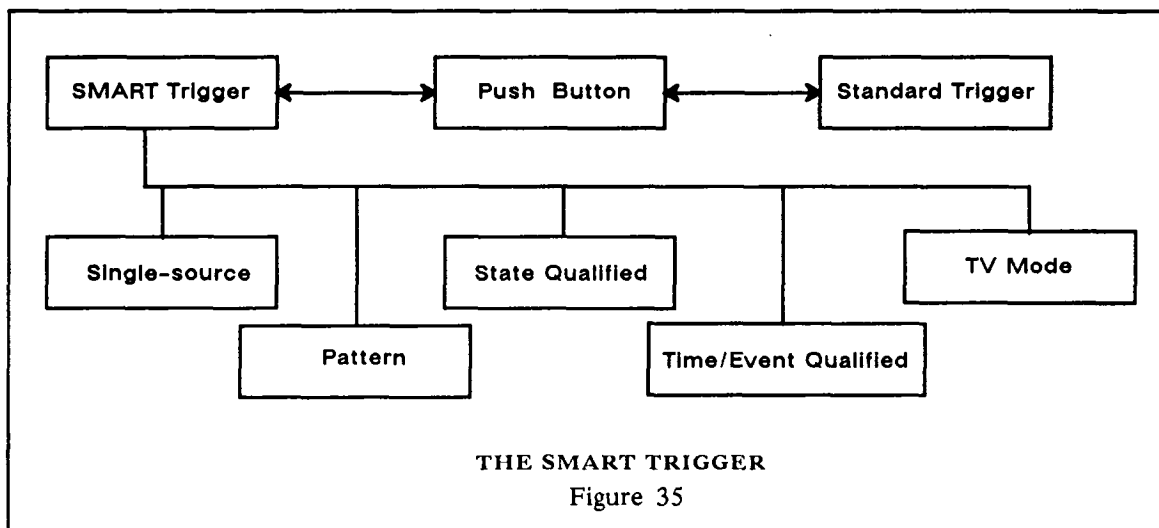

APPLICATIONS

To capture rare phenomena such as glitches or spikes, logic states or missing bits, an oscilloscope must be able to trigger on elusive events. The 9424 offers a variety of sophisticated trigger modes based on two important facilities:

- a) The ability, by using a counter which can be pre-set, to count a specified number of events (1 to 10^9), or alternatively to measure time intervals up to 20 sec.

This feature can be applied either to introduce a post-trigger hold-off, which can be set as a number of events or as a time interval, or to trigger on pulse widths or on pulse separations greater or smaller than a value chosen by the user, or to count the time or number of events after a starting condition before allowing a trigger.

- b) The ability to sense the logic state of the trigger sources Channel 1, Channel 2 and Channel 4, and to trigger on a chosen logic combination.

◆ *Note: On the 9424E oscilloscope with External trigger option, Channel 4 is replaced by EXT. In this case all references to Channel 4 should be interpreted as referring to EXT.*

Single-source Triggers

There are two types of single-source triggers in the 9424. These are the Hold-off and Width-based triggers. Details of how to set up these triggers are given later in this section.

Hold-off

Trigger hold-off is necessary for a stable display of complex repetitive waveforms. Depending on the application, the waveforms may consist of a sequence of digital pulses or pure analog pulses. Therefore, it may sometimes be convenient to define the hold-off in terms of number of pulses, and in terms of time for other applications, even though both may give rise to the same result. What is important is that the hold-off has to be a multiple of the period of the complex waveform, where the period is measured in terms of time or number of events.

It should be noted that the hold-off is started by potential triggers (and not at the end of an acquisition). Potential triggers will be accepted if the oscilloscope is armed but will be ignored if the oscilloscope is still busy handling the previous trigger. In fact the hold-off ensures synchronization between successive real triggers.

Width-based Trigger

The width-based trigger is a major innovation in oscilloscopes. Two possibilities exist:

- a) **Pulse Width**, i.e. the time from the trigger source transition of a given slope to the next transition of *opposite* slope.
- b) **Interval Width**, i.e. the time from the trigger source transition of a given slope to the next transition of the *same* slope.

After selecting a pulse or an interval width, the user can choose to trigger on widths smaller or greater than the given value. This feature offers a wide range of capabilities for application fields as diverse as digital and analog electronic development, ATE, EMI, telecommunications, and magnetic media studies. Catching elusive rare glitches becomes very easy. In digital electronics, where the circuit under test normally uses an internal clock, a glitch can be theoretically defined as any pulse which has a width smaller than the clock period (or half period). The oscilloscope can selectively trigger only on those events.

In a much broader sense, a glitch can be defined as a pulse much faster than the waveform under observation. Glitches are a source of problems in many applications. Therefore, the possibility of triggering on a glitch, investigating what generated it and measuring the damage caused by it, represents a fundamental tool.

The trigger on pulse widths smaller than a given value has been named FASTGLITCH.

FASTGLITCH trigger mode, like the other modes, can be selected at any time-base setting. The user can define widths with 2.5 nsec resolution starting at a minimum value of 2.5 nsec. For recurrent glitches, the oscilloscope's random interleaved sampling mode allows glitch visualization with an equivalent sampling rate of up to 10 gigasamples/sec, that is one sample point every 100 psec.

Missing bits in long data streams are easily triggered on using the interval width triggering facility. For ranging applications, interval trigger may be used to ignore unwanted signal reflections.

Multi-source Triggers

There are four types of multi-source triggers in the 9424. These are the Pattern, State Qualified, Time/Event Qualified, and TV triggers. Details of how to set up these triggers are given later in this section.

Pattern Trigger

A pattern trigger is defined as a logical AND combination of the states of Channel 1, Channel 2 and Channel 4. The states are defined as being either low (L) or high (H) or don't care (X) with respect to the individually defined trigger thresholds. Furthermore, the user decides whether the oscilloscope should trigger at the beginning of the defined pattern or at the end, i.e. when the pattern is "entered" or "exited".

The FASTGLITCH and time-separation trigger capabilities described above can be combined with pattern trigger, enabling the user to compare the "duration" of the pattern, or the interval between patterns, with a reference time. This also applies to the hold-off by time or number of events.

The pattern trigger will be appreciated every time complex logic has to be tested. Examples are: computer or microprocessor debugging; High Energy Physics where a physical event is identified by several events occurring simultaneously; and debugging of data transmission busses in telecommunications.

When set to pattern trigger, the oscilloscope always checks the logic AND of the defined input logic states. However, with the help of de Morgan's laws, the pattern becomes much more general. To demonstrate this, consider an example which is of particular importance, that is a *bi-level or window trigger*.

Bi-level trigger means that the user is expecting a single-shot signal where the amplitude will go outside a known range in either direction.

To set up a bi-level trigger the signal should be connected to two inputs, Channel 1 and Channel 2 (or any other pair of triggerable inputs). For example, the threshold of Channel 1 should be set to +100 mV and the threshold of Channel 2 to -200 mV. The required bi-level trigger will occur if the oscilloscope triggers on Channel 1 for any pulse greater than + 100 mV *or* on Channel 2 for any pulse more negative than - 200 mV. For improved precision, the gains of the two channels should be at the same setting.

In Boolean notation we can write:

$$\text{Trigger} = \text{CH1} + \overline{\text{CH2}}$$

i.e. trigger when entering the pattern, CH1 = high OR CH2 = low.

By de Morgan's laws this is equivalent to:

$$\text{Trigger} = \overline{\overline{\text{CH1}} \cdot \text{CH2}}$$

i.e. trigger when exiting the pattern

$$\text{CH1} = \text{low AND CH2} = \text{high}$$

This configuration can be programmed easily.

The possibility of setting the threshold individually for each channel extends this method to a more general window trigger where, in order to have a trigger it is required that the input pulse amplitude lies within or outside a given arbitrary window.

Another important aspect of the pattern trigger is that all the features already examined for the single-source trigger mode can also be used. That is, the user again has the choice of imposing a hold-off by time or by number of events or alternatively to compare the "duration" or the intervals which are greater or smaller than a time duration specified by the user.

The pattern trigger has been designed to let the user choose the trigger point. By choosing LHX entering, the trigger will be given at the moment that the pattern LHX becomes true. If we now add the condition $\text{pattern width} < \text{reference time}$, this will refer to the width of the pattern $\overline{\text{LHX}}$ preceding the trigger point. Therefore, this trigger mode checks the repetition rate of the pattern.

On the other hand, if LHX exiting is chosen with pattern width < reference time, then the duration of the LHX state will be compared with the reference time and the trigger will be given when LHX becomes false. See Figure 36.

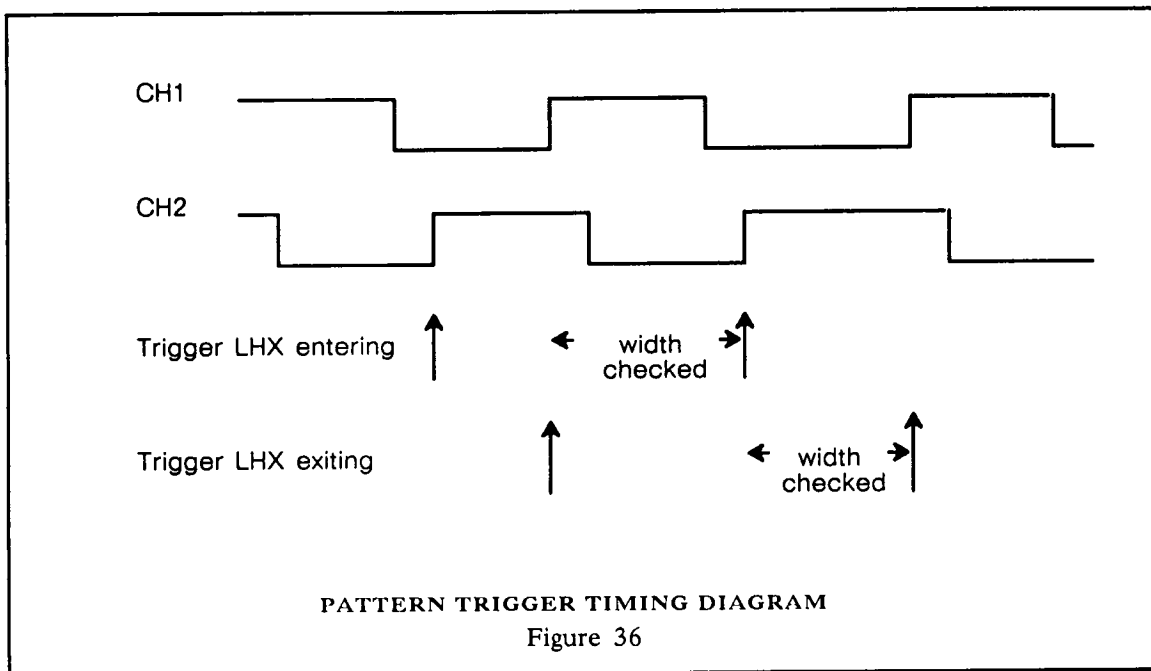

6 The SMART Trigger

State Qualified Trigger

In this mode a transition into a user-defined logic state of two inputs starts a predetermined time delay or trigger count. The logic state serves as an enabling condition to the third input which is the source of the trigger. The logic state must remain valid in order that the trigger occurs (see Figure 37). It is important to note that the time delay or trigger count is restarted every time the logic state is entered.

Typical applications can be found wherever time violations may occur, for example in micro-processor debugging or telecommunications.

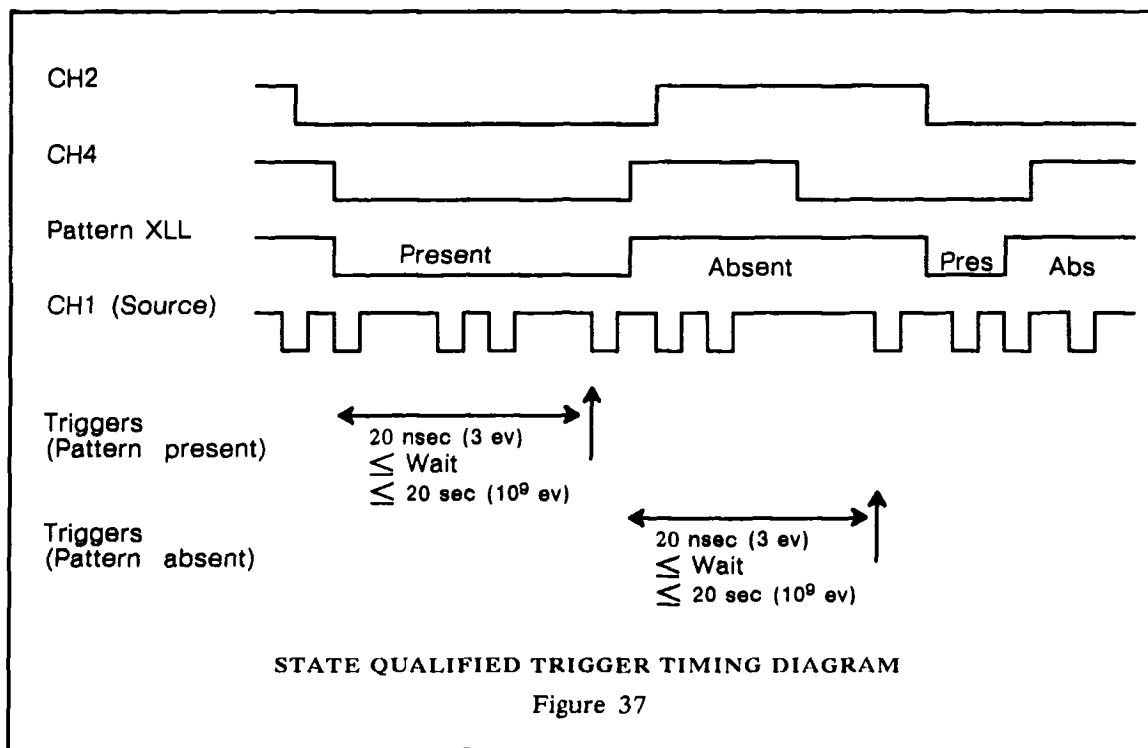

Time/Event
Qualified Trigger

This trigger is similar to the State Qualified trigger. The differences are that the logic state can be defined on three inputs and that it is not necessary for the logic state to remain valid in order to have a trigger. Therefore, the logic state starts a delay by time or number of events, after which triggering is enabled (see Figure 38). It should be noted that, unlike the State Qualified trigger, the delay is not restarted by every transition into the state. The trigger must occur or the acquisition must be stopped and restarted (by changing the trigger mode from Normal to Single to Normal or from Single armed to Single trig'd to Single ready).

This trigger mode provides a solution to applications involving systems with long firing jitter time, e.g. lasers and magnetic discs.

Other applications for the Time/Event qualified trigger can be found in telecommunications or microprocessors for debugging of asynchronous data buses.

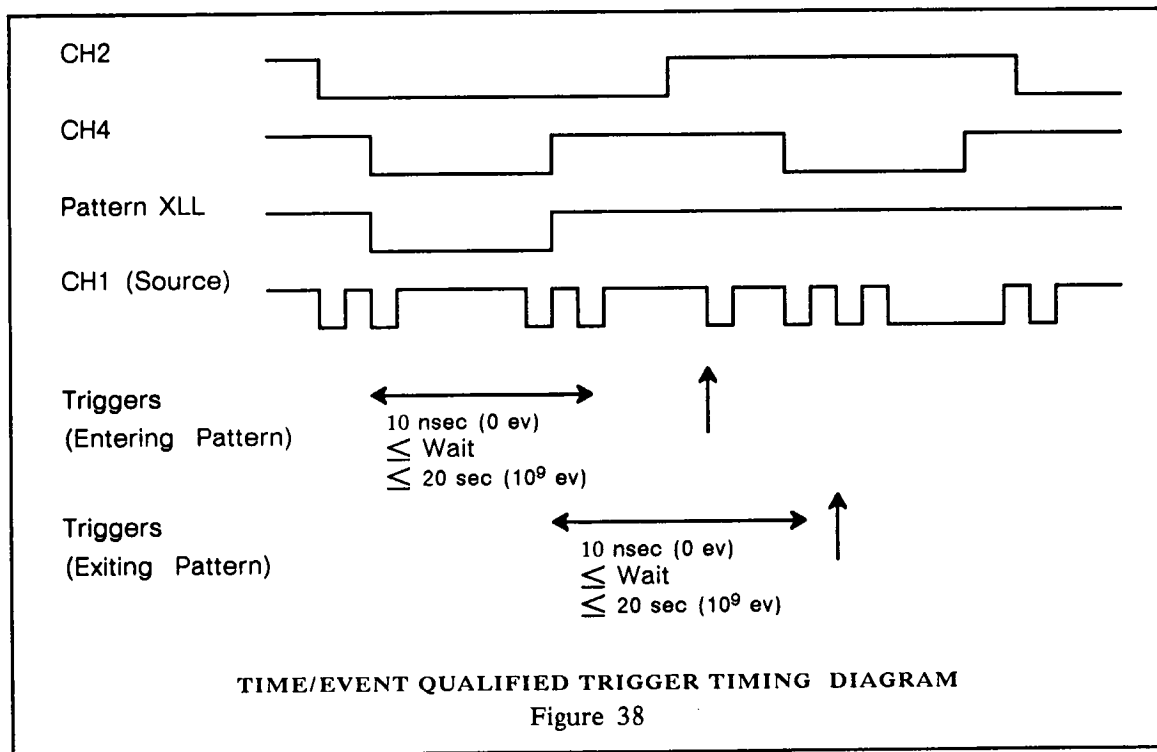

TV Trigger

This trigger is a special form of the Time/Event Qualified trigger. A composite video signal on the Channel 3 input is analyzed to provide a signal for the beginning of the chosen field (any, odd, or even) and a signal at the beginning of each line (Figure 39). The field signal provides the starting transition and the beginning of line pulses are counted to allow the final trigger on the chosen line. LeCroy's TV trigger includes an enhanced field counting capability which can maintain the trigger on a known field relative to some initial trigger (FIELDLOCK). The field, number of fields and the field rate, interlace factor, and number of lines/picture must be specified for this feature. Standard settings exist for the most popular forms of TV signals. The TV trigger can also function in a simple any line mode. Applications can be found wherever TV signals are present.

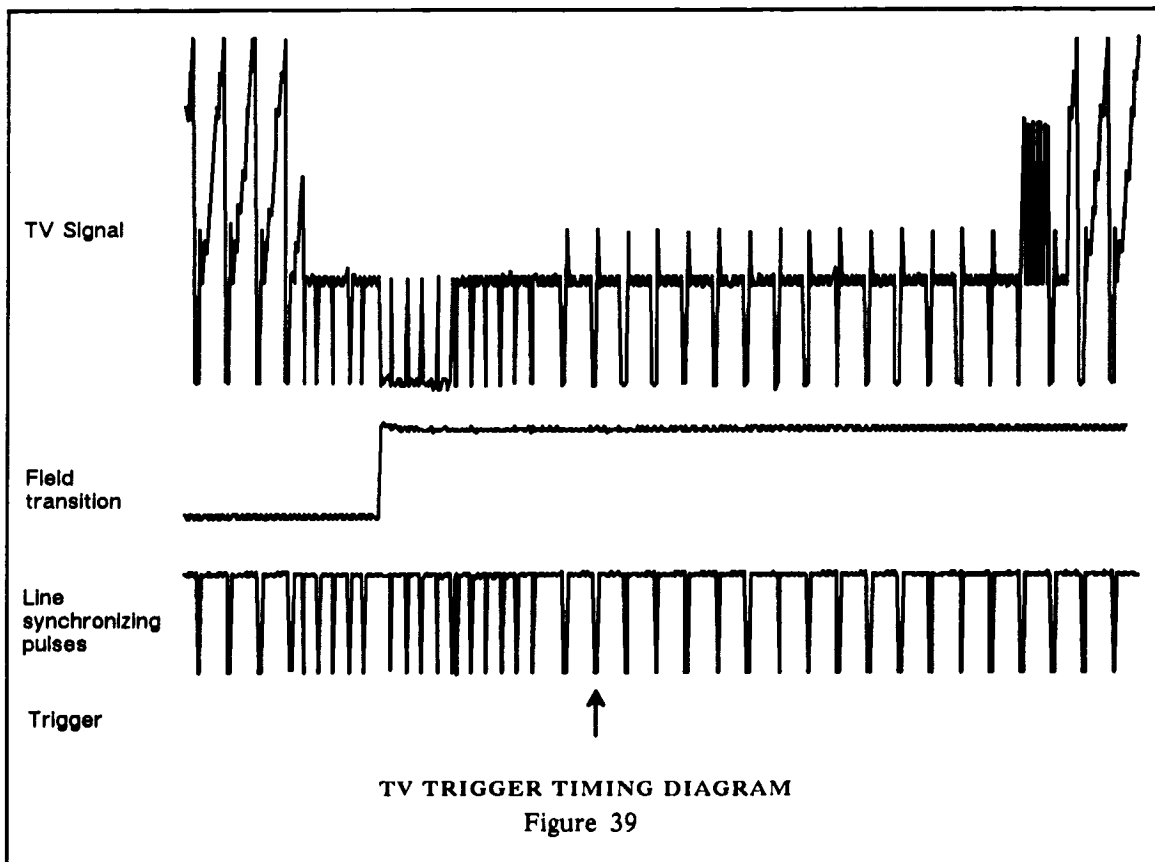

MANIPULATING THE SMART TRIGGER

SMART Trigger Controls

Full details of setting the standard trigger parameters, delay, level, slope, coupling and mode are given in Section 5.

SMART trigger, button (35), switches between the SMART and standard trigger modes. Figure 40 shows the SMART trigger controls.

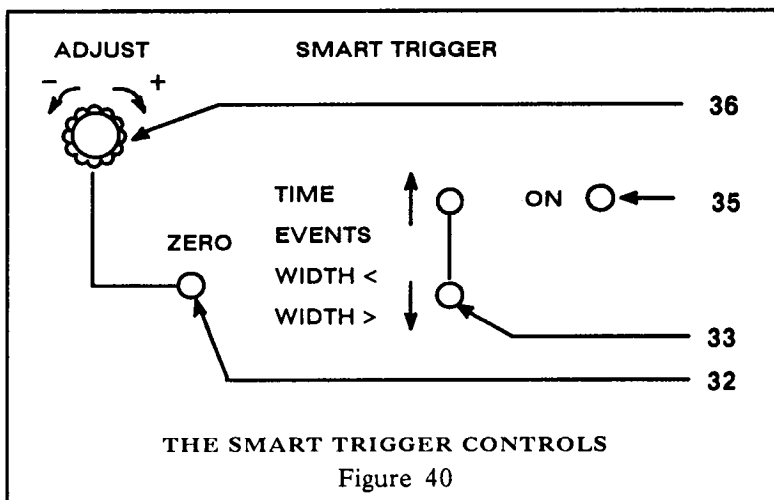

Delay may be set to 0 by pressing the **Zero** button (32).

Time, **Events**, **Width <**, and **Width >** are selected using button (33) and their settings can be adjusted using the **Adjust** knob (36). When the **Adjust** knob is used in conjunction with hold-off by time, pressing the **Zero** button (32) sets the hold-off to the minimum value of 12.5 nsec or 0 events respectively. When the **Adjust** knob is used with width trigger, pressing the **Zero** button sets the width to its minimum value for each particular trigger mode.

SMART Trigger Menu

The SMART trigger is switched on and off using the **SMART trigger** button (35). The **ON** LED beside the button lights up and the following message appears in the Message field (IX):

Inspect/Modify SMART TRIG in PANEL status menu.

Note that the SMART trigger remains configured as it was when it was previously used. SMART trigger configurations are also stored when a front-panel setup is stored using the **Save Panel** button (4) in the Main menu. Figure 41 shows an example of a typical SMART trigger menu.

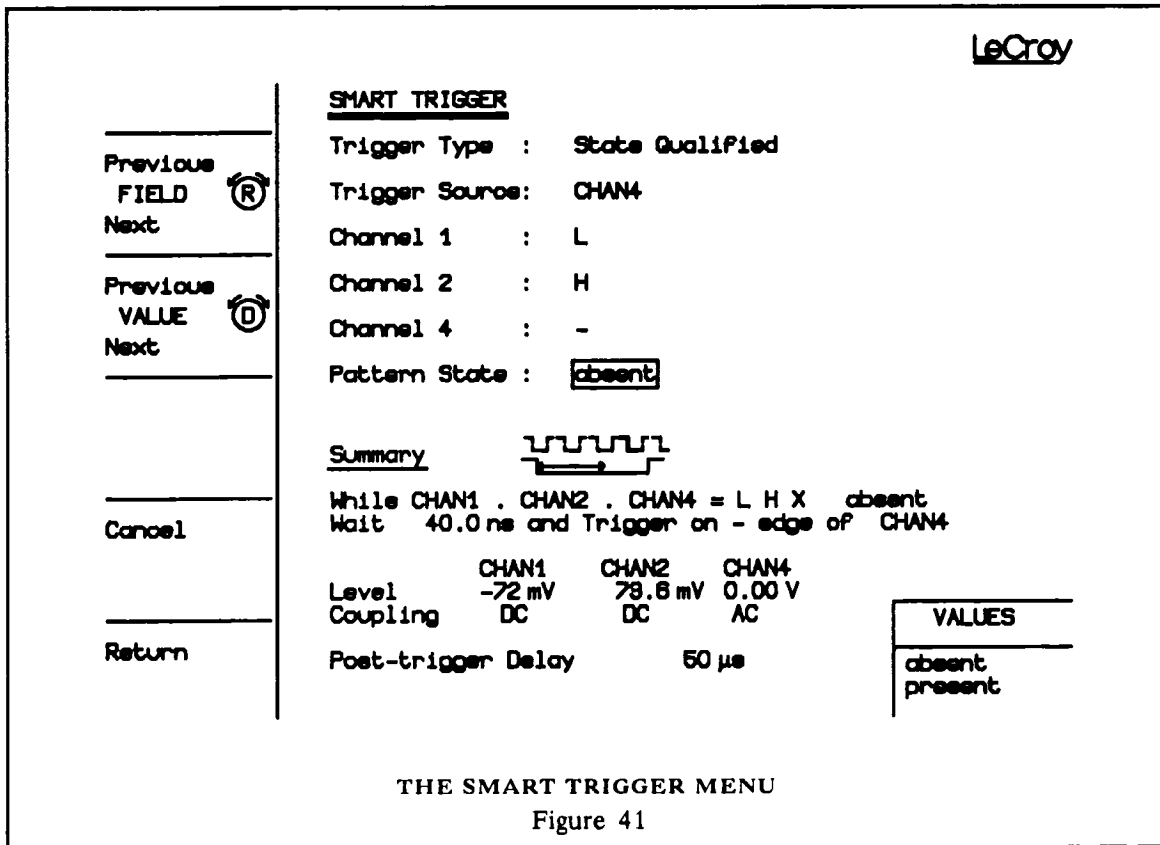

The SMART trigger menu is accessed by pressing the Panel Status button (2) of the Main menu and then pressing the Modify SMART Trigger button (2).

Buttons (2) and (3) and the Reference knob (48) allow the user to select the required parameter. Buttons (4) and (5) and the Difference knob (46) are used to adjust a selected parameter.

Pressing the Cancel button (8) returns the oscilloscope to the SMART trigger configuration which was set when the menu was first entered. Pressing Return, button (10), returns the oscilloscope to the Panel Status menu.

Trigger Graphics

To help the user rapidly interpret SMART trigger configurations, a visual indication of the trigger is given by the oscilloscope's special trigger graphics. Examples of typical SMART trigger graphics, together with descriptions are given in Figure 42.

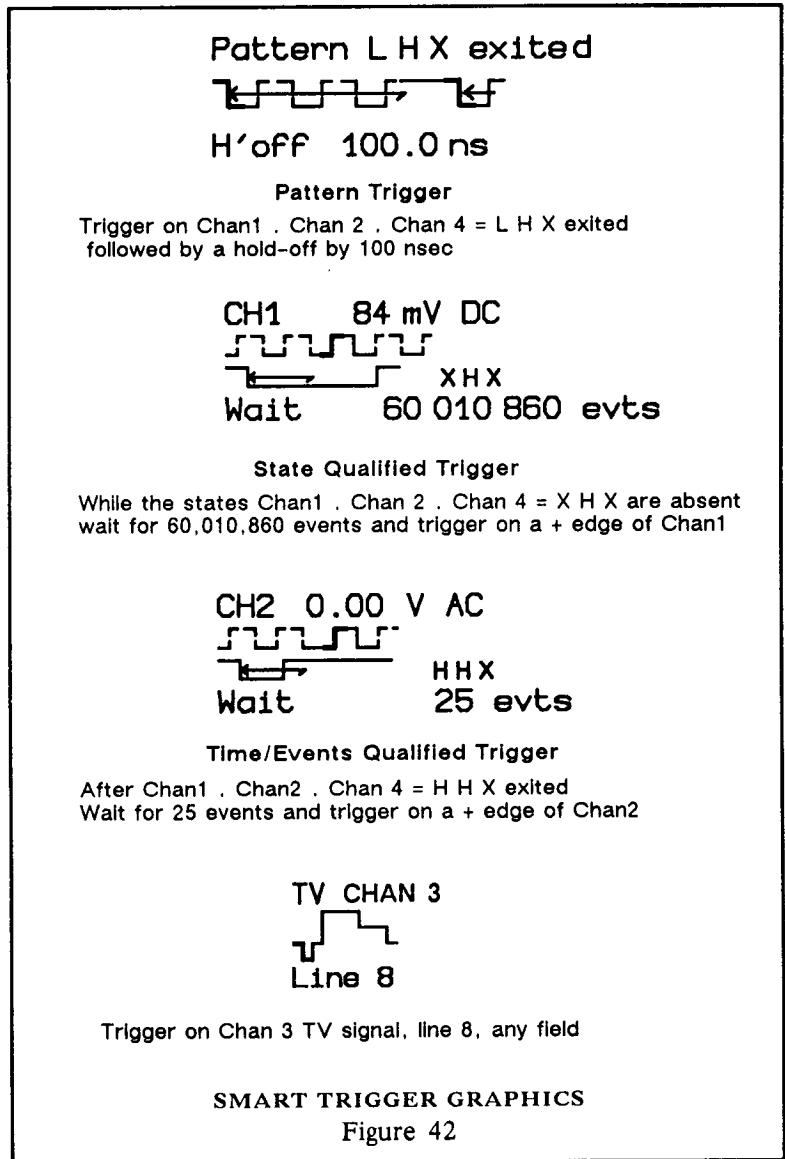

SINGLE-SOURCE TRIGGER MODES

The Single-source trigger is schematically represented in Figure 43.

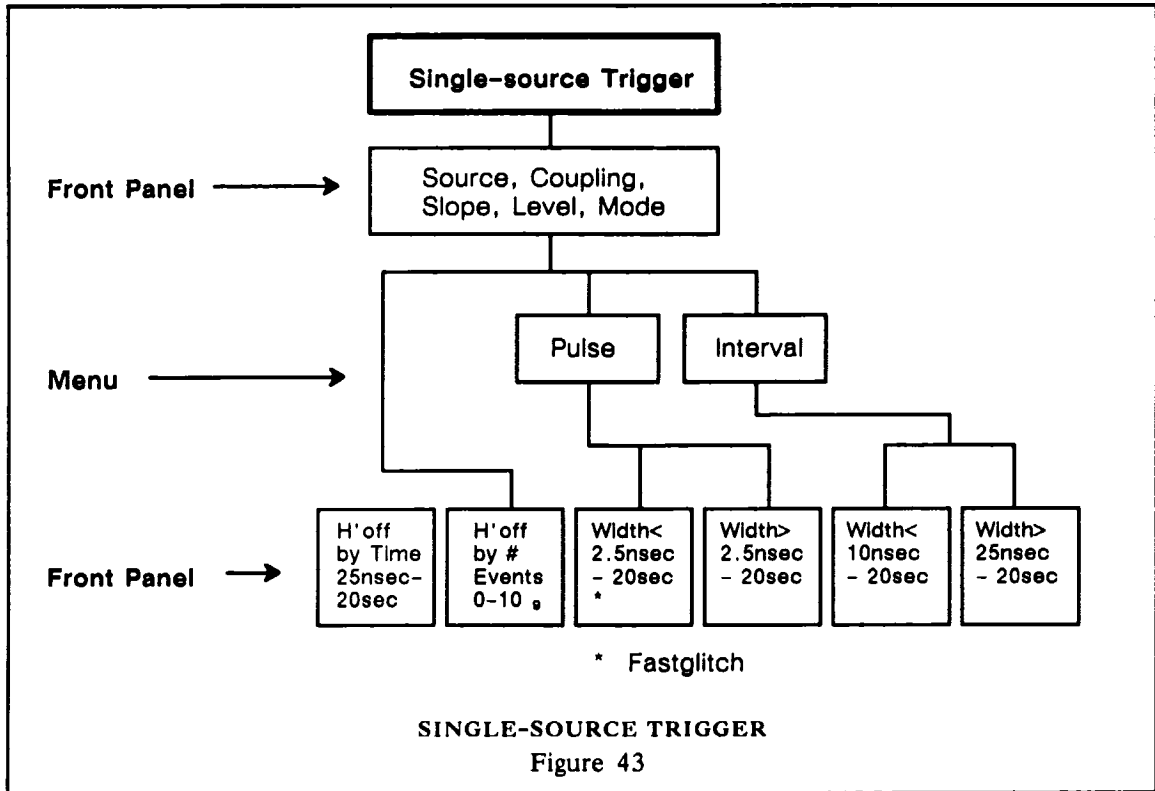

Hold-off

Two different hold-offs are available:

Hold-off by time: 25 nsec to 20 sec

Hold-off by number of events: 0 to 1,000,000,000 events.

Pressing the **Zero** button (32) sets the hold-off to the minimum value.

Hold-off By Time

1) Set the trigger **Level, Delay, Coupling, Slope** and **Source** as required. These parameters can be set before or after entering the SMART trigger menu. They must be set, however, when the SMART trigger is OFF.

2) Ensure that the SMART trigger is switched ON. (The LED beside button (35) should be lit.)

- 3) Press **Modify SMART Trig** in the Panel Status menu to enter the SMART trigger menu.
- 4) Use buttons (2) and (3) or the **Reference knob (48)** to select **Trigger Type**.
- 5) Use buttons (4) and (5) or the **Difference knob (46)** to set **Trigger Type** to **Single Source**.

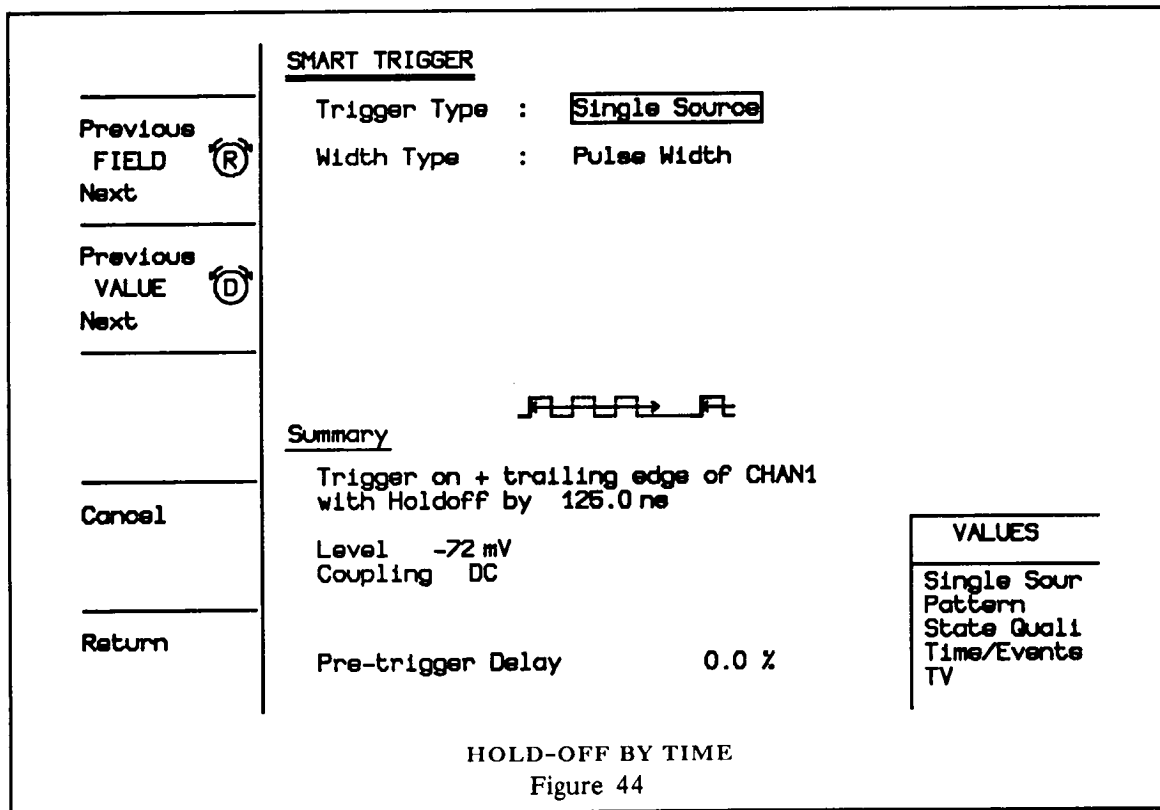

- 6) Select **Time** using button (33). Figure 44 shows the screen display. (Note that although **Width Type** is indicated on the screen it is only relevant if either the **Width <** or **Width >** LEDs are lit.)
- 7) The **Adjust knob (36)** can then be used to set the hold-off (in the range 25 nsec through 20 sec).
- 8) The minimum hold-off can be obtained by pressing the **Zero button (32)**. This gives a 12.5 nsec hold-off. The screen shows: No wait.

6 The SMART Trigger

Hold-off By
Number Of Events

- 1) Set the trigger Level, Delay, Coupling, Slope and Source as required. These parameters can be set before or after entering the SMART trigger menu. However, they should be set when the SMART trigger is OFF.

NO or SLOW TRIGGER
LeCroy

Previous FIELD (R)
Next

Previous VALUE (D)
Next

Cancel

Return

SMART TRIGGER

Trigger Type : Single Source

Width Type : Pulse Width

Summary



Trigger on + trailing edge of CHAN2
with Holdoff by 5 evts

Level 1.0 mV
Coupling DC

Pre-trigger Delay 10.0 %

VALUES
Interval W1
Pulse Width

HOLD-OFF BY NUMBER OF EVENTS

Figure 45

- 2) Ensure that the SMART trigger is switched ON. (The LED beside button (35) should be lit.)
- 3) Press **Modify SMART Trig** in the Panel Status menu to enter the SMART trigger menu.
- 4) Use buttons (2) and (3) or the **Reference knob (48)** to select **Trigger Type**.
- 5) Use buttons (4) and (5) or the **Difference knob (46)** to set **Trigger Type** to **Single Source**.

- 6) Select **Events** using button (33). Figure 45 shows the screen display. (Note that although **Width Type** is indicated on the screen it is only relevant if either the **Width <** or **Width >** LEDs are lit.)
- 7) The **Adjust** knob (36) can then be used to set the hold-off (in the range 1 event through 10^9 events).
- 8) If no hold-off by events is required, press the **Zero** button (32). In this case a minimum hold-off of 12.5 nsec will occur.

Pulse Width-based Trigger Modes

Width-based triggers operate on a given pulse width, or a given interval between pulses. Two pulse-width based triggers are available as shown in Figure 46 and described below:

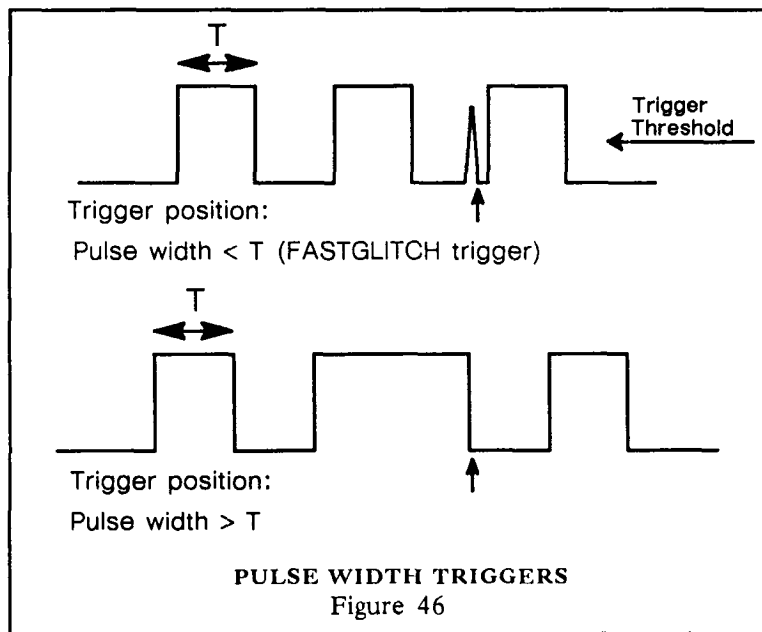

Pulse width < a specified pulse width (FASTGLITCH): The oscilloscope triggers on opposite slopes of pulses narrower than a specified value. Values in the range 2.5 nsec through 20 sec may be chosen.

Pulse width > a specified pulse width: The oscilloscope triggers on opposite slopes of pulses wider than a specified value. Values in the range 2.5 nsec through 20 sec may be entered.

6 The SMART Trigger

Pulse Width <
a Specified Value
(FASTGLITCH)

- 1) Set the trigger Level, Delay, Coupling, Slope and Source as required. These parameters can be set before or after entering the SMART trigger menu. However, they must be set when the SMART trigger is OFF.

NO or SLOW TRIGGER
LeCroy

Previous FIELD (R)
Next

Previous VALUE (D)
Next

Cancel

Return

SMART TRIGGER

Trigger Type : Single Source

Width Type : Pulse Width



Summary

Trigger on + trailing edge of CHAN2
if Pulse Width < 500 ns

Level 1.0 mV
Coupling AC

Pre-trigger Delay 15.0%

VALUES

Interval W1
Pulse Width

PULSE WIDTH < A SPECIFIED VALUE

Figure 47

- 2) Ensure that the SMART trigger is switched ON. (The LED beside button (35) should be lit.)
- 3) Press **Modify SMART Trig** in the Panel Status menu to enter the SMART trigger menu.
- 4) Use buttons (2) and (3) or the **Reference knob** (48) to select **Trigger Type**.
- 5) Use buttons (4) and (5) or the **Difference knob** (46) to set **Trigger Type** to **Single Source**.
- 6) Use buttons (2) and (3) or the **Reference knob** (48) to select **Width Type**.

- 7) Use buttons (4) and (5) or the **Difference knob (46)** to set **Width Type to Pulse Width**.
- 8) Select **Width <** using button (33). Figure 47 shows the screen display.
- 9) The **Adjust knob (36)** can then be used to set the pulse width (in the range 2.5 nsec through 20 sec).

Note: The separation between the leading edges of two consecutive pulses should be greater than 10 nsec in order to correctly measure the width. If this condition is not satisfied, the width measurement can be affected by a maximum error of 10 nsec.

Pulse Width >
a Specified Value

- 1) Set the trigger **Level, Delay, Coupling, Slope and Source** as required. Note that they can also be set after entering the SMART trigger menu. However, they must be set when the SMART trigger is OFF.
- 2) Ensure that the SMART trigger is switched ON. (The LED beside button (35) should be lit.)
- 3) Press **Modify SMART Trig** in the Panel Status menu to enter the SMART trigger menu.
- 4) Use buttons (2) and (3) or the **Reference knob (48)** to select **Trigger Type**.
- 5) Use buttons (4) and (5) or the **Difference knob (46)** to set **Trigger Type to Single Source**.
- 6) Use buttons (2) and (3) or the **Reference knob (48)** to select **Width Type**.
- 7) Use buttons (4) and (5) or the **Difference knob (46)** to set **Width Type to Pulse Width**.
- 8) Select **Width >** using button (33).
- 9) The **Adjust knob (36)** can then be used to set the pulse width (in the range 2.5 nsec through 20 sec).

Interval Width based Trigger Modes

Two interval width based triggers are available as indicated in Figure 48 and described below.

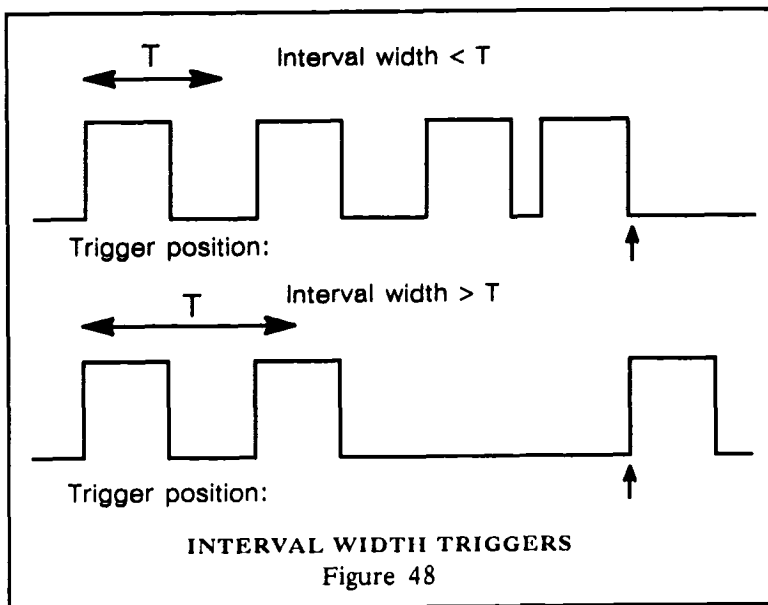

Interval Width < a Specified Width: The oscilloscope triggers on similar slopes of signals narrower than a value in the range 10 nsec through 20 sec.

Interval Width > a Specified Width: The oscilloscope triggers on similar slopes of signals wider than a value in the range 25 nsec through 20 sec.

Interval Width < a Specified Value

- 1) Set the trigger **Level, Delay, Coupling, Slope** and **Source** as required. These parameters can be set before or after entering the SMART trigger menu. However, they must be set when the SMART trigger is OFF.
- 2) Ensure that the SMART trigger is switched ON. (The LED beside button (35) should be lit.)
- 3) Press **Modify SMART Trig** in the Panel Status menu to enter the SMART trigger menu.
- 4) Use buttons (2) and (3) or the **Reference knob (48)** to select **Trigger Type**.
- 5) Use buttons (4) and (5) or the **Difference knob (46)** to set **Trigger Type** to **Single Source**.

- 6) Use buttons (2) and (3) or the **Reference knob (48)** to select **Width Type**.
- 7) Use buttons (4) and (5) or the **Difference knob (46)** to set **Width Type** to **Interval Width**.
- 8) Select **Width <** using button (33). Figure 49 shows the screen display.
- 9) The **Adjust knob (36)** can then be used to set the interval width (in the range 10 nsec through 20 sec).

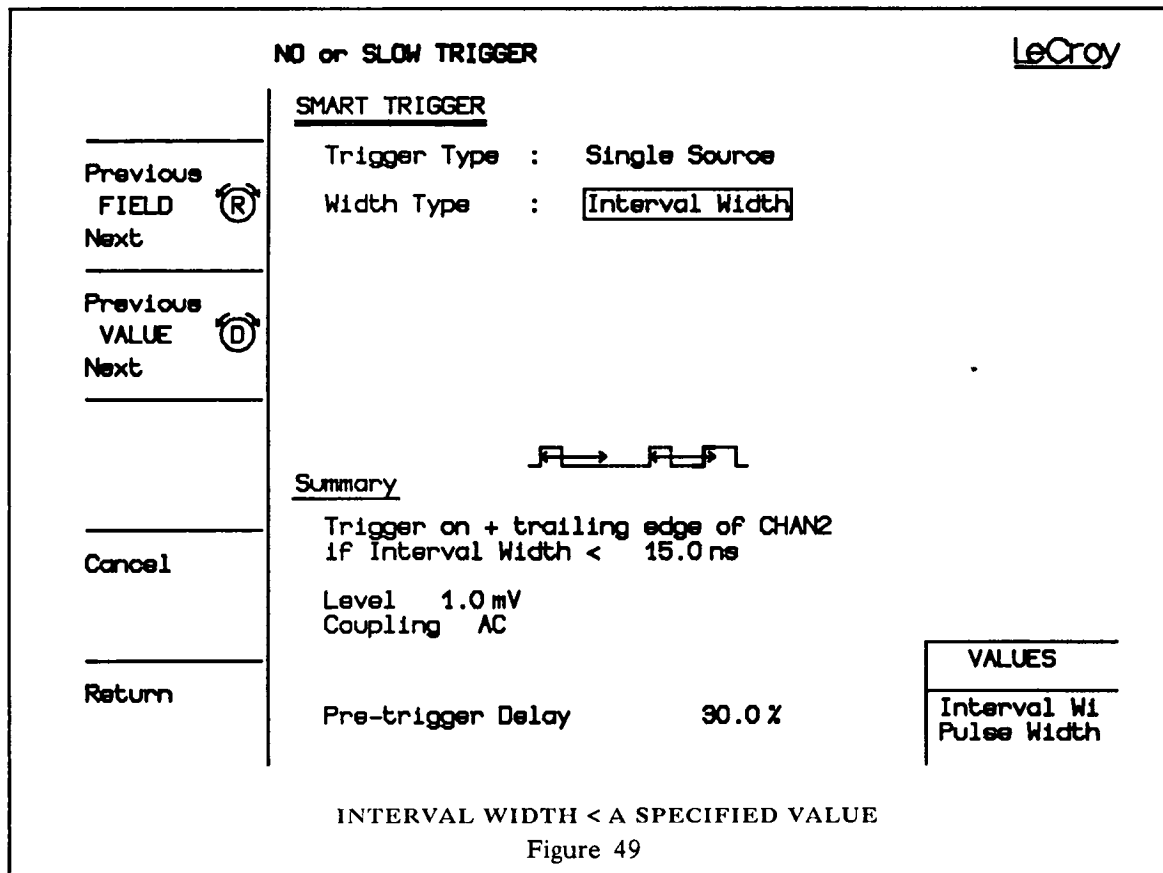

6 *The SMART Trigger*

Interval Width >
a Specified Value

- 1) Set the trigger **Level, Delay, Coupling, Slope** and **Source** as required. These parameters can be set before or after entering the SMART trigger menu. However, they must be set when the SMART trigger is OFF.
- 2) Ensure that the SMART trigger is switched ON. (The LED beside button (35) should be lit.)
- 3) Press **Modify SMART Trig** in the Panel Status menu to enter the SMART trigger menu.
- 4) Use buttons (2) and (3) or the **Reference** knob (48) to select **Trigger Type**.
- 5) Use buttons (4) and (5) or the **Difference** knob (46) to set **Trigger Type** to **Single Source**.
- 6) Use buttons (2) and (3) or the **Reference** knob (48) to select **Width Type**.
- 7) Use buttons (4) and (5) or the **Difference** knob (46) to set **Width Type** to **Interval Width**.
- 8) Select **Width >** using button (33).
- 9) The **Adjust** knob (36) can then be used to set the interval width (in the range 25 nsec through 20 sec).

MULTI-SOURCE TRIGGER MODES

The 9424 has three trigger sources, **Chan 1, Chan 2, and Chan 4**, each of which can be defined as high (H), low (L) or don't care (X). By setting the sources as required, several multi-source trigger features are available.

Pattern Trigger

The oscilloscope triggers on the logic AND of the three sources. The user can choose whether the oscilloscope triggers when the state is entered (i.e. as soon as the pattern is valid) or exited (i.e. when the pattern is no longer valid). The pattern trigger is schematically represented in Figure 50.

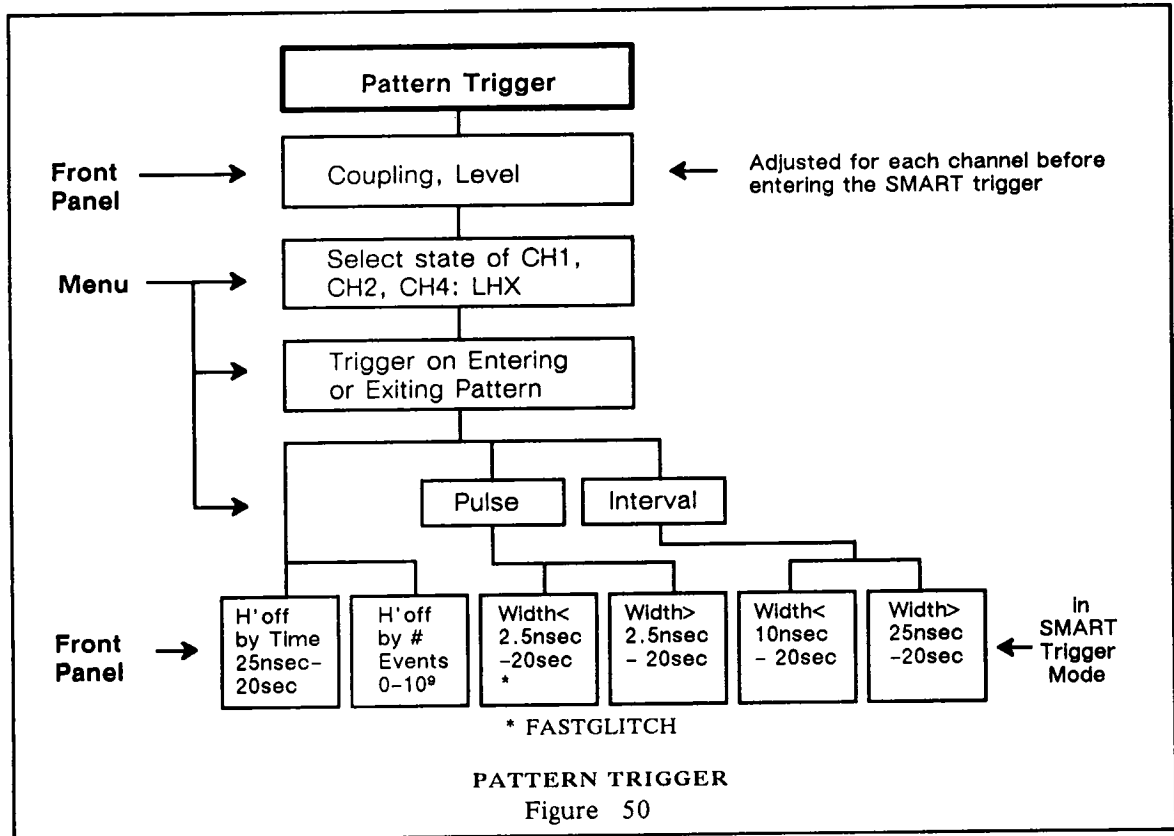

Note: To practice manipulating the SMART trigger, the user should configure at least one pulse/interval width trigger and one trigger with hold-off as described above before setting up the pattern, state qualified or time events qualified triggers.

6 The SMART Trigger

Adjusting the Pattern Trigger

- 1) Set the trigger Level, Delay, and Coupling for each source as required. These parameters can be set before or after entering the SMART trigger menu. However, they must be set while the SMART trigger is OFF.
- 2) Ensure that the SMART trigger is switched ON. (The LED beside button (35) should be lit.)
- 3) Press **Modify SMART Trig** in the Panel Status menu to enter the SMART trigger menu.
- 4) Use buttons (2) and (3) or the **Reference knob (48)** to select **Trigger Type**.
- 5) Use buttons (4) and (5) or the **Difference knob (46)** to set **Trigger Type** to **Pattern**. Figure 51 indicates a typical Pattern trigger menu.

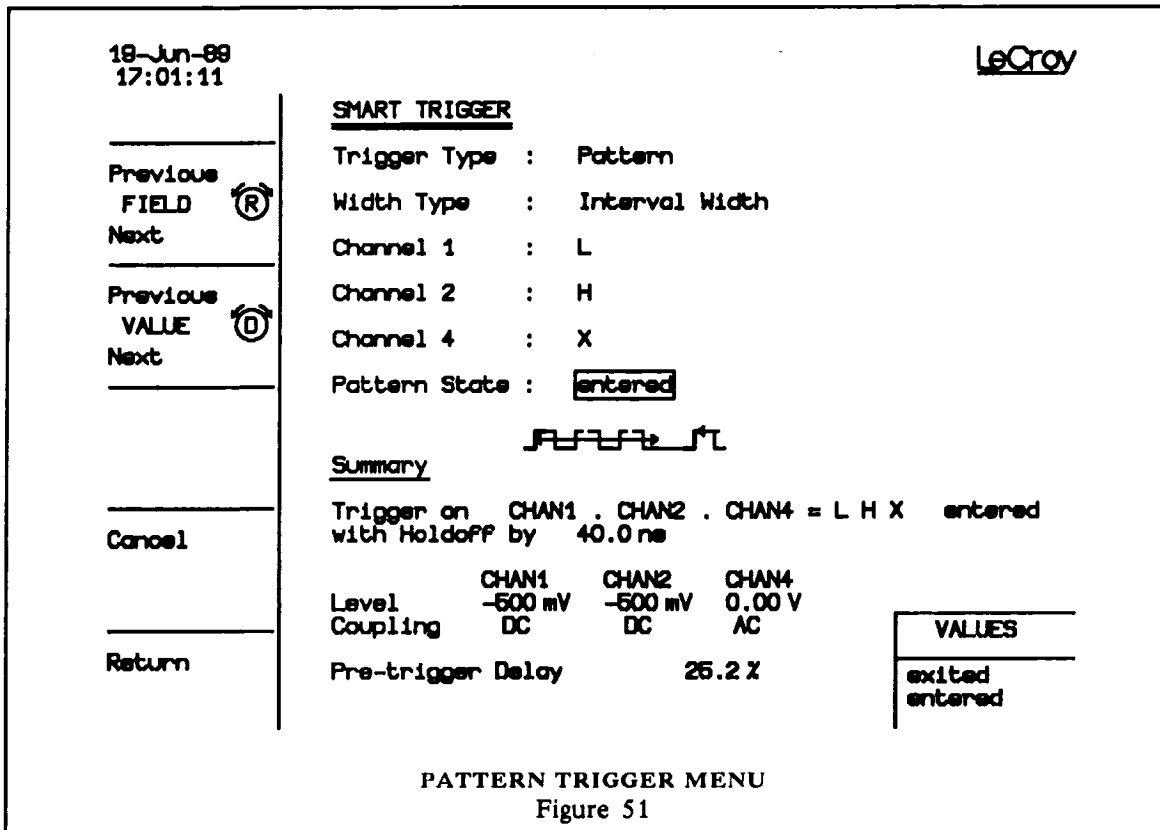

To configure the **Pattern** trigger the following parameters must be set:

- * The pattern itself. Channel 1, Channel 2 and Channel 4 can be set to either high (H), low (L) or don't care (X).
- * Whether the oscilloscope should trigger when the pattern begins (entered) or when the pattern ends (exited).
- * Other conditions, i.e.

Hold-off by time or events

Pulse width < or > than a specified value,

Interval width < or > than a specified value.

- 6) Use the **Reference** and **Difference** controls to select and set **Channel 1**, **Channel 2** and **Channel 4** to the required logic states.
- 7) Select **Pattern State** and set it to **entered** or **exited** as required.
- 8) There are now some further options:
 - a) Triggering independently of pattern width or interval width, with no hold-off.

Use button (33) to select **Time** or **Events** and then press the **Zero** button (32).
 - b) Triggering at the beginning or end of a pattern followed by a hold-off by time or events.

Use button (33) to select **Time** or **Events** and use the **Adjust** knob (36) to set the hold-off as required.

Range: Hold-off by time: 25 nsec to 20 sec.
 Hold-off by events: 1 to 10⁹ events.
 No hold-off: = 12.5 nsec
 - c) Triggering at the beginning or end of a pattern if the time since the last pattern or of the pattern itself is < or > a specified value.

Select **Width Type** and set it to **Pattern Width**. Use button (33) to select **Width <** or **Width >** as required. Set the width using the **Adjust** knob (36).

Range: Pattern width <: 2.5 nsec to 20 sec.
 Pattern width >: 2.5 nsec to 20 sec.

Note: The separation between the leading edges of two consecutive pulses should be greater than 10 nsec to correctly measure the width. If this condition is not satisfied, the width measurement can be affected by a maximum error of 10 nsec.

- d) Triggering at the beginning or end of a pattern if the time since the previous transition of this type is < or > a specified value.

Select **Width Type** and set it to **Interval Width**. Use button (33) to select **Width <** or **Width >** as required. Set the width using the **Adjust knob** (36).

Range: Interval width <: 10 nsec to 20 sec.
Interval width >: 25 nsec to 20 sec.

Bi-level Trigger

This variation of Pattern trigger allows the oscilloscope to trigger on any signal (connected simultaneously to two trigger channels) that exceeds a preset high or low trigger level. The third source must be set to don't care. This is also known as a window trigger since the oscilloscope will trigger whenever the signal leaves the allowed region. In the following this will be known as a transition. This mode allows the oscilloscope to trigger when a transition occurs regardless of whether the slope is positive or negative.

Adjusting the Bi-level Trigger

- 1) Use a T-connector to connect the same signal to Channel 1 and 2 (or any other pair of triggerable sources).
- 2) Ensure that cables connected to Channels 1 and 2 are the same length. This is very important as the signals must arrive at both inputs at exactly the same time.
- 3) Set the trigger **Level**, **Delay**, and **Coupling** as required. These parameters can be set before or after entering the SMART trigger menu. However, they must be set when the SMART trigger is OFF.

Note: In this example, it is crucial that the trigger level of Channel 1 be lower than the trigger level of Channel 2. The best way to verify this is by looking at the real signal.

- 4) Ensure that the SMART trigger is switched ON. (The LED beside button (35) should be lit.)
- 5) Press **Modify SMART Trig** in the panel status menu to enter the SMART trigger menu.
- 6) Use buttons (2) and (3) or the **Reference knob** (48) to select **Trigger Type**.
- 7) Use buttons (4) and (5) or the **Difference knob** (46) to set **Trigger Type** to **Pattern**.
- 8) Use the **Reference** and **Difference** controls to select and set **Channel 1** to high (H), **Channel 2** to low (L), and **Channel 4** to don't care (X).

- 9) Select **Pattern State** and set it to **exited**.
- 10) There are now some further options:
- a) Triggering on any transition with no hold-off.
Use button (33) to select **Time** or **Events** and then press the **Zero** button (32).
- b) Triggering on a transition followed by a hold-off by time or events.
Use button (33) to select **Time** or **Events** and use the **Adjust** knob (36) to set the hold-off as required.
- Range:**
- | | |
|---------------------|------------------------------|
| Hold-off by time: | 25 nsec to 20 sec. |
| Hold-off by events: | 1 to 10 ⁹ events. |
| No hold-off: | = 12.5 nsec |
- c) Triggering on a transition if the time since the last signal transition is < or > a specified value.
Select **Width Type** and set it to **Pattern Width**.
Use button (33) to select **Width <** or **Width >** as required.
Set the width using the **Adjust** knob (36).
- Range:**
- | | |
|------------------|---------------------|
| Pattern width <: | 2.5 nsec to 20 sec. |
| Pattern width >: | 2.5 nsec to 20 sec. |
- Note: The separation between two consecutive transitions should be greater than 10 nsec to correctly measure the width. If this condition is not satisfied, the width measurement can be affected by a maximum error of 10 nsec.*
- d) Triggering on a transition if the time since the previous transition is < or > a specified value.
Select **Width Type** and set it to **Interval Width**.
Use button (33) to select **Width <** or **Width >** as required.
Set the width using the **Adjust** knob (36).
- Range:**
- | | |
|-------------------|--------------------|
| Interval width <: | 10 nsec to 20 sec. |
| Interval width >: | 25 nsec to 20 sec. |

State Qualified Trigger

The oscilloscope triggers on any source if a certain pattern of the other two trigger sources is present. It is also possible to specify a delay by time or number of events which starts as soon as the pattern becomes valid. A schematic diagram is shown in Figure 52.

Note: A transition from pattern invalid to pattern valid is necessary to start the delay (if it is not set to zero).

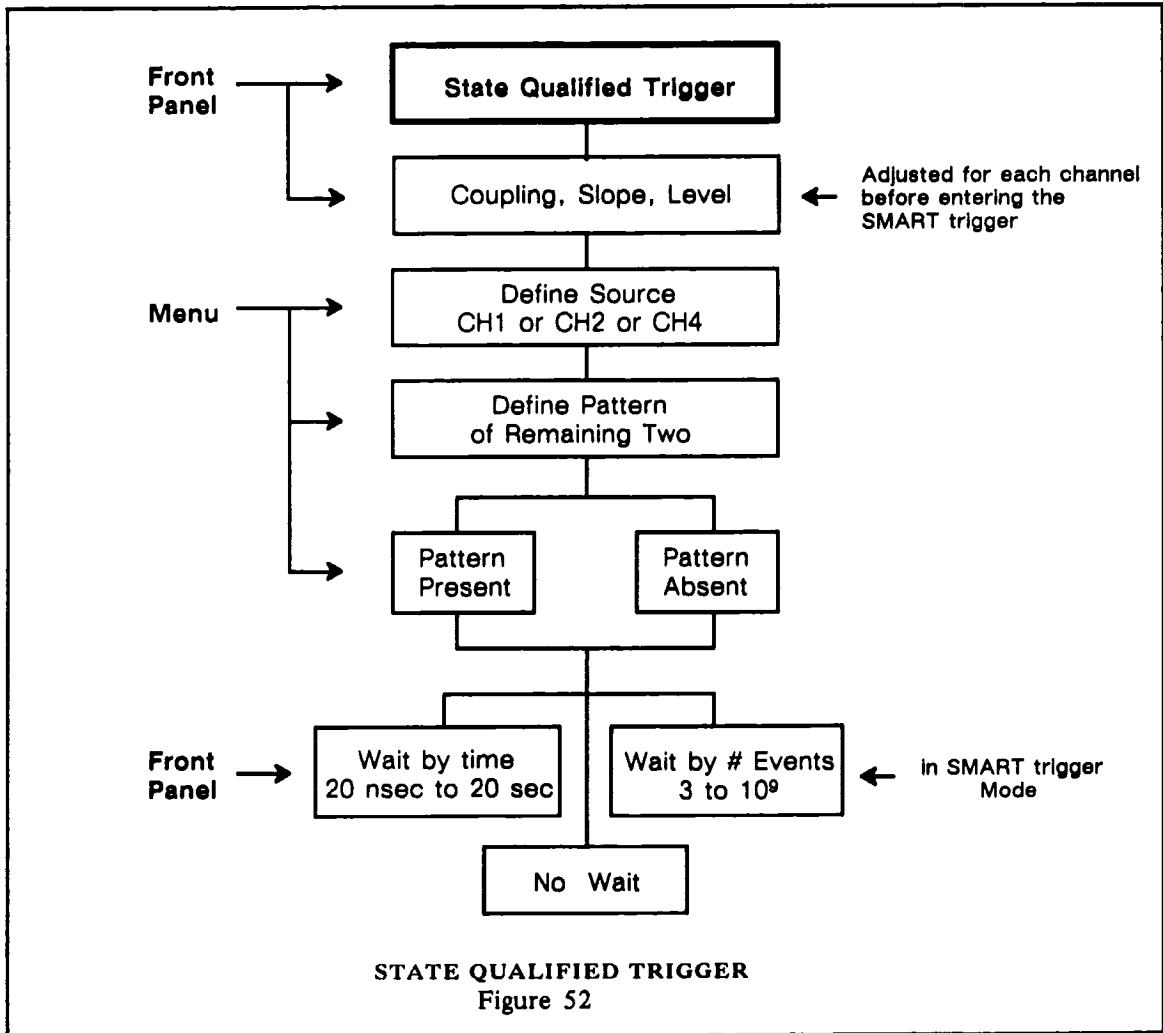

Adjustments

- 1) Set the trigger **Level, Delay, Coupling, and Slope** as required. These parameters can be set before or after entering the SMART trigger menu. However, they should be set when the SMART trigger is OFF.
- 2) Ensure that the SMART trigger is switched ON. (The LED beside button (35) should be lit.)
- 3) Press **Modify SMART Trig** in the Panel Status menu to enter the SMART trigger menu.
- 4) Use buttons (2) and (3) or the **Reference knob (48)** to select **Trigger Type**.
- 5) Use buttons (4) and (5) or the **Difference knob (46)** to set **Trigger Type to State Qualified**. Figure 53 indicates a typical state qualified trigger configuration.

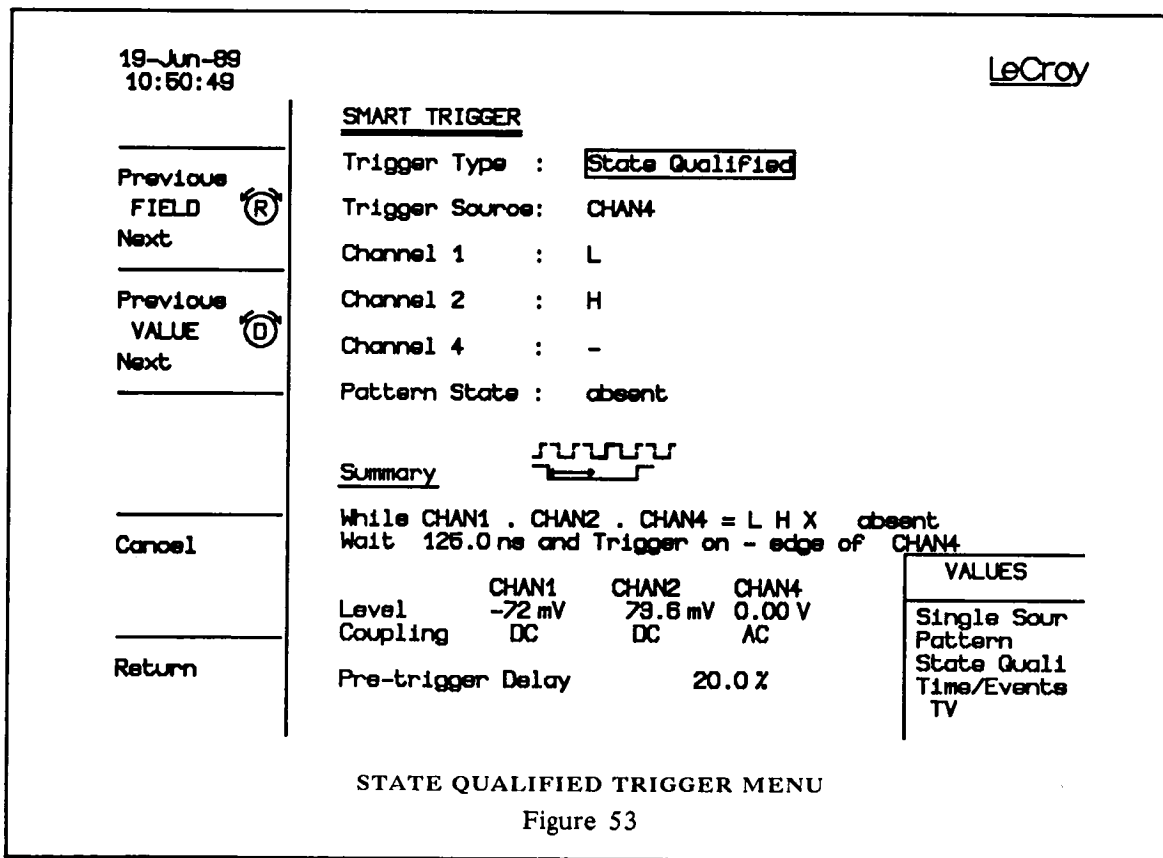

To configure the State Qualified trigger the following parameters must be set:

- * The trigger source, **Chan 1, Chan 2, Line** or **Chan 4** (or **Ext** for the 9424E).
 - * The required logic pattern of **Chan 1, Chan 2** and **Chan 4**.
 - * Whether the oscilloscope should trigger when the pattern is absent or present.
 - * Other conditions, i.e. a hold-off by time or events.
- 6) Use the **Reference** and **Difference** controls to select **Trigger Source** and set it to **Chan 1, Chan 2, Line** or **Chan 4** as required.
 - 7) Set the **Pattern** trigger sources to the required logic states **H, L** or **X**.
 - 8) Select **Pattern State** and set it to **absent** or **present** as required.
 - 9) There are now some further options:
 - a) **Triggering without a waiting period.**

Use button (33) to select **Time** or **Events** and then press the **Zero** button (32).

In this case the oscilloscope will trigger on the first source event with the required logic pattern. It will not require a transition of the pattern.
 - b) **Triggering when a certain pattern of two trigger sources is present or absent followed by a delay by time or events.**

Use button (33) to select **Time** or **Events** and use the **Adjust** knob (36) to set the delay as required.

Range:	Wait by time:	20 nsec to 20 sec.
	Wait by events:	3 to 10 ⁹ events.

Time/Event Qualified Trigger

The oscilloscope triggers on any source as soon as a certain pattern of the three trigger sources is entered or exited. From the moment of validity of the pattern, a delay can be defined in terms of time or number of trigger events. Note that the delay follows a trigger and is not restarted by every transition of the pattern. A schematic drawing of the Time/Events qualified trigger is given in Figure 54.

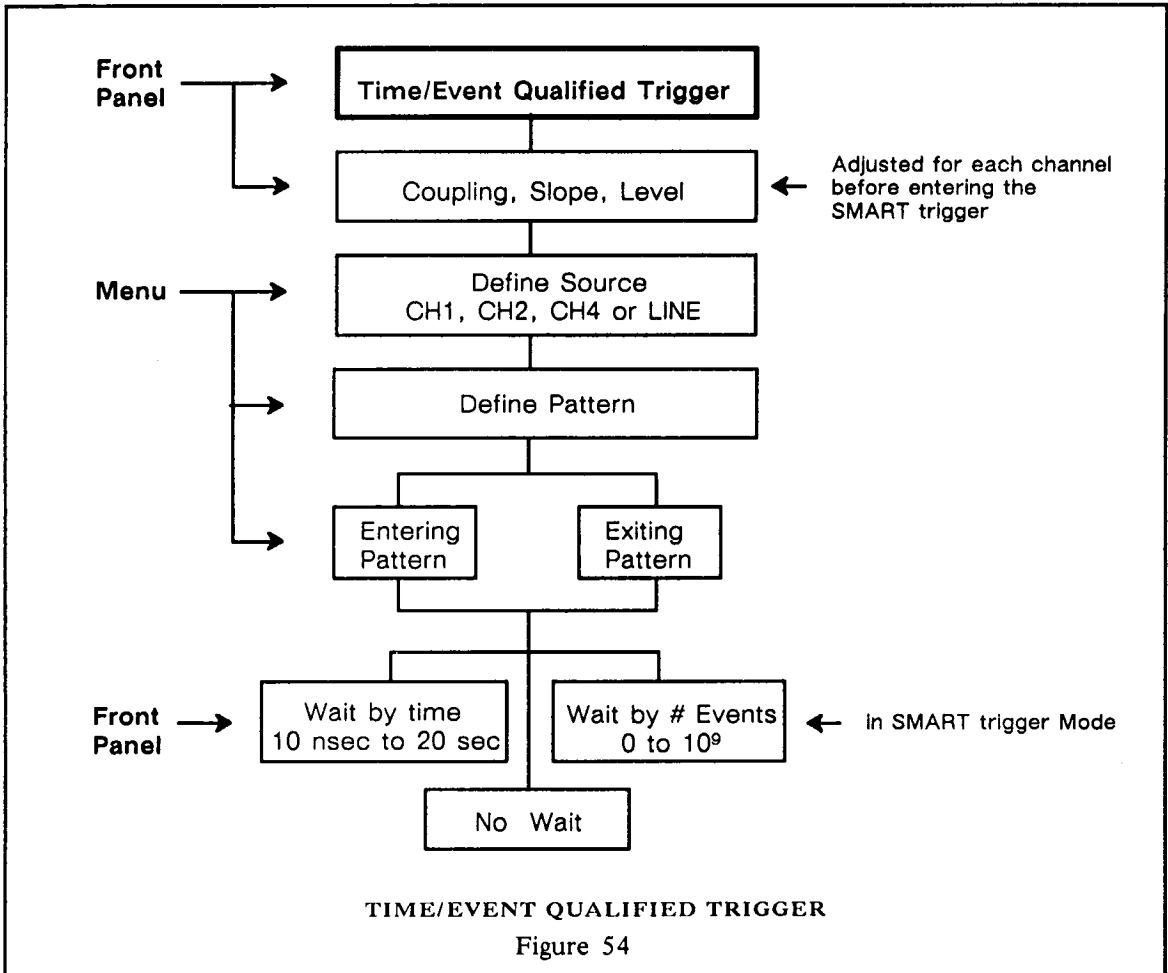

Adjustments

- 1) Set the trigger Level, Delay, and Slope as required. These parameters can be set before or after entering the SMART trigger menu. However, they should be set when the SMART trigger is OFF.

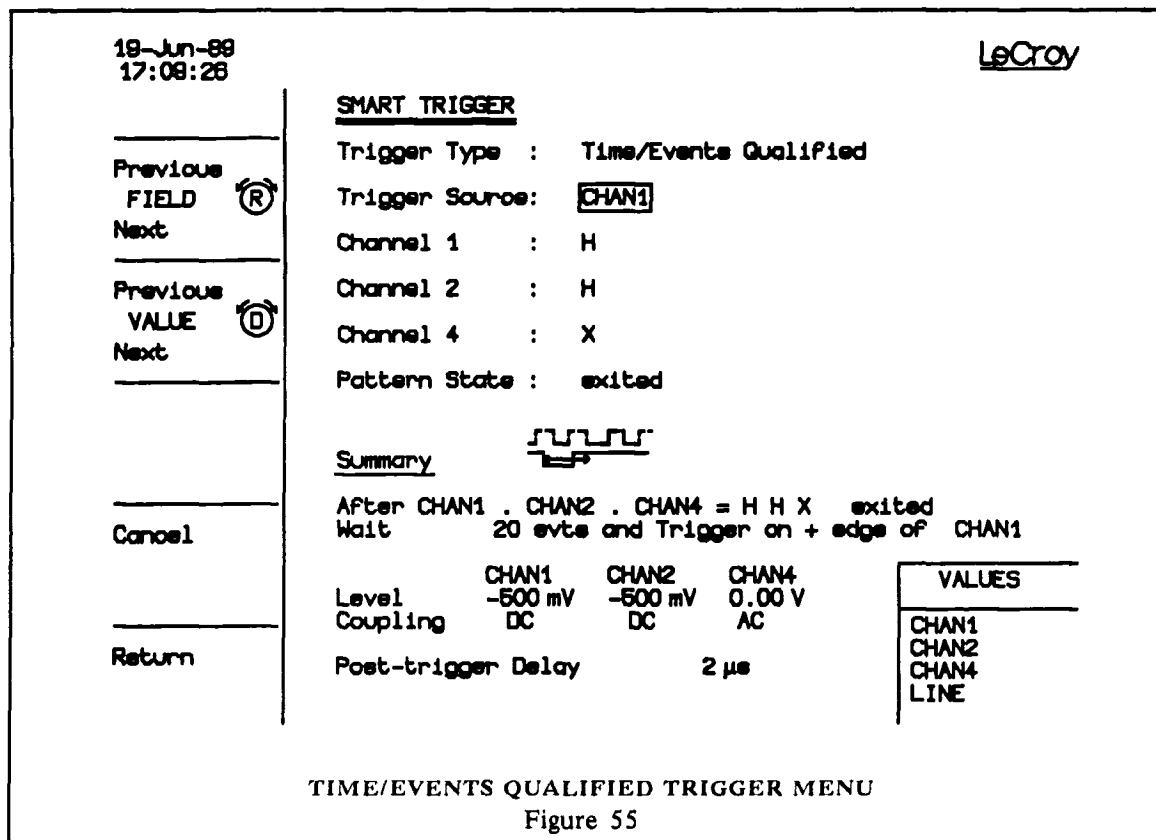

- 2) Ensure that the SMART trigger is switched ON. (The LED beside button (35) should be lit.)
- 3) Press **Modify SMART Trig** in the Panel Status menu to enter the SMART trigger menu.
- 4) Use buttons (2) and (3) or the **Reference knob (48)** to select **Trigger Type**.
- 5) Use buttons (4) and (5) or the **Difference knob (46)** to set **Trigger Type to Time/Events Qualified**.

- 6) Use the **Reference** and **Difference** controls to select **Trigger Source** and set it to **Chan 1, Chan 2, Line** or **Chan 4** as required.
- 7) Set the **Pattern** trigger sources to the required logic states **H, L** or **X**.
- 8) Select **Pattern State** and set it to **entered** or **exited** as required. A typical time/events qualified trigger configuration is shown in Figure 55.

To configure the **Time/Events qualified** trigger the following parameters must be set:

- * The trigger source, **Chan 1, Chan 2, Line** or **Chan 4**.
- * The required logic pattern of **Chan 1, Chan 2, and Chan 4** (or **Ext** for the 9424E).
- * Whether the oscilloscope should trigger when the pattern is entered or exited.
- * Other conditions, i.e. a wait by time or events.

9) There are now some further options:

a) Triggering without a waiting period.

Use button (33) to select **Time** or **Events** and then press the **Zero** button (32).

Note: A transition from pattern invalid to pattern valid is always necessary.

b) Triggering on a chosen source as soon as a certain pattern of the three sources is entered or exited and a delay by time or events has been satisfied.

Use button (33) to select **Time** or **Events** and use the **Adjust knob** (36) to set the wait as required.

Range:	Wait by time:	10 nsec to 20 sec.
	Wait by events:	0 to 10 ⁹ events.

TV Trigger

The oscilloscope triggers on the beginning of the chosen line of a composite video signal on the **Channel 3** input. A schematic drawing of the TV trigger is shown in Figure 56.

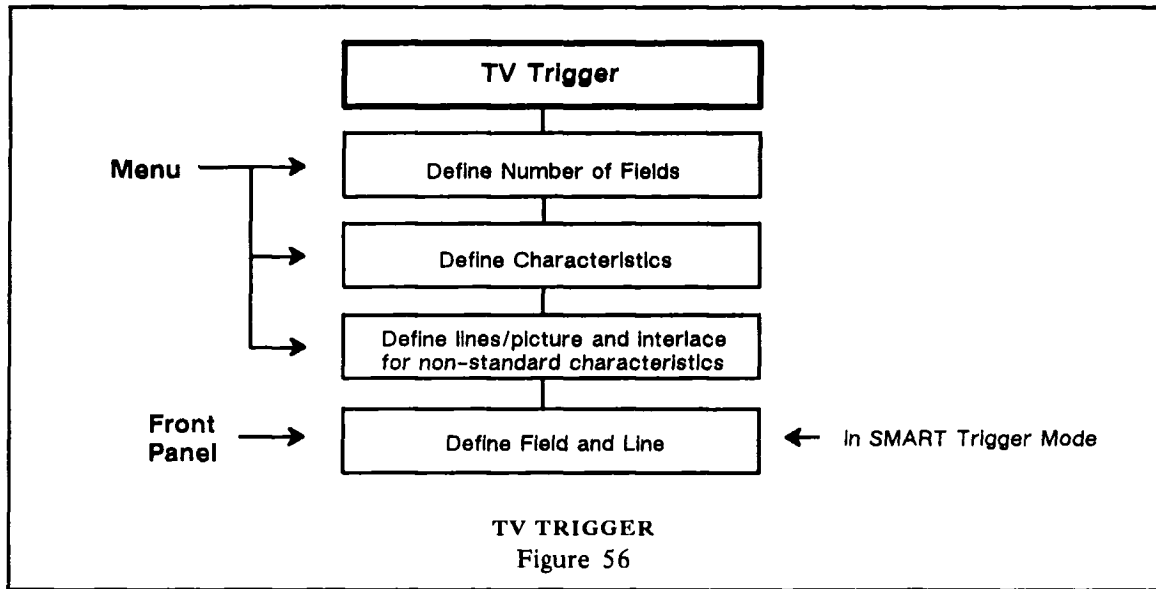

Adjusting the TV trigger

- 1) Ensure that the SMART trigger is switched ON. (The LED beside button (35) should be lit.)
- 2) Press **Modify SMART Trig** in the Panel Status menu to enter the SMART trigger menu.
- 3) Use buttons (2) and (3) or the **Reference knob** (48) to select **Trigger Type**.
- 4) Use buttons (4) and (5) or the **Difference knob** (46) to set **Trigger Type** to TV.
- 5) Use buttons (2), (3), (4) and (5) to set the required **Number of Fields**.
- 6) Use buttons (2), (3), (4) and (5) to set the required **Characteristics**.
- 7) For non-standard characteristics, select the **Lines/picture and Interlace**.

Figure 57 shows a typical TV trigger configuration.

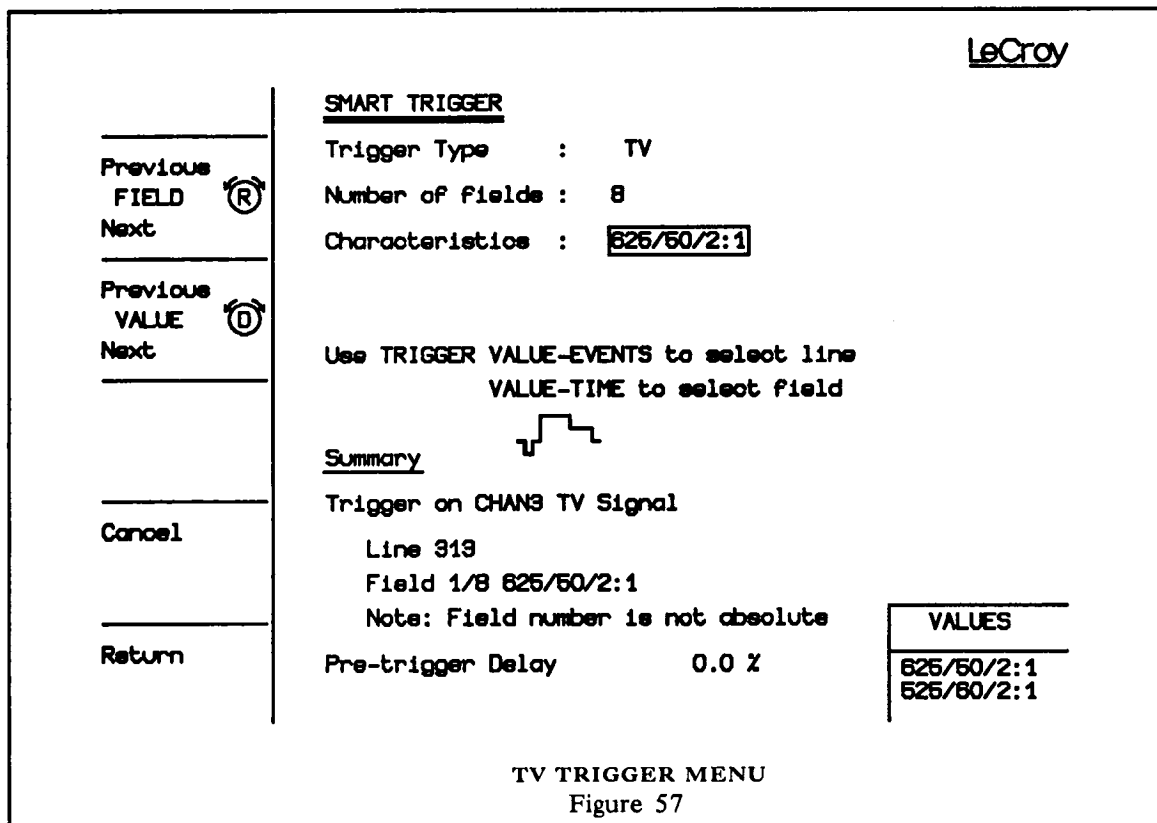

- 8) There are now some further options:
- a) Triggering on any line
 Use button (33) to select Events and then press the Zero button (32).
 - b) Triggering on a particular line
 Use button (33) to select Events and then the Adjust knob (36) to select the line.
 - c) Triggering on a particular field
 Use button (33) to select Time and then the Adjust knob (36) to select the field.

Note: The Channel 3 gain coupling and offset can be adjusted over a large range according to the user's needs. However, for extreme settings of gain or offset, the trigger will not function. An auto-setup on Channel 3 will usually bring the signal back into an acceptable position.

Notes

A. The enhanced field-counting capability (FIELDLOCK) allows the oscilloscope to trigger consistently on a chosen line within a chosen field of the signal. Most TV systems have more than two fields. For example, with the number of fields set to 8 on the oscilloscope, the required line is triggered on and the user can examine all of its characteristics in a reproducible way. It should be noted that the field numbering system is relative in that the oscilloscope cannot distinguish between lines 1, 3, 5, and 7 (or 2, 4, 6, and 8) in an absolute way. Once the oscilloscope has started to trigger on a particular line of a particular field, changes of field or line are treated in the usual manner. However, it is up to the user to determine the absolute numbering of the chosen field if necessary. A warning message will be displayed if the instrument is forced to restart its field synchronization procedure. (This message is often an indication of incorrect parameters in the TV trigger setup menu.)

B. For each of the characteristics the following remarks apply:

1) 625/50/2:1 (European style PAL and SECAM systems)

This setting should be used for most of the standard 50 field/sec signals. The lines may be selected in the range 1 to 626 where line 626 is identical to line 1. The lines are numbered in the standard way. The required field and number of fields must be set appropriately in order to select lines with numbers above 313.

Number of fields = 8 should be very useful for color PAL signals. Number of fields = 4 is appropriate for SECAM signals.

2) 525/60/2:1 (American style NTSC systems)

This setting should be used for standard 60 field/sec NTSC signals. The lines are selectable in the range 1 to 1050. The lines are numbered in the standard way. The desired field and number of fields must be set appropriately in order to select lines with numbers above 262 or 525.

Number of fields = 4 should be very useful for American-style NTSC systems.

3) 7/50?, 7/60?

In order to allow maximum flexibility, no line-counting convention is used. The line count should be thought of as a line-synchronizing pulse count, and it includes the transitions of the equalizing pulses. For certain extreme cases of TV signals, the field transition recognition will no longer work. In this case, only the "any line" mode will be available.

- C. The enhanced field-counting capability cannot be used for RIS acquisitions.
- D. Composite video signals must have negative-going synch to be decoded correctly.

The PASS/FAIL test features built into the oscilloscope enable it to compare any parameters of source waveforms against reference values and, if certain conditions are met, to perform a number of selected actions.

For instance, the oscilloscope can be set up to PASS if:

- the waveform in Channel 1 is contained in the mask in Memory C (all points inside the mask).

AND - the frequency in Channel 2 is less than 10 kHz.

AND - the max point in Function F is more than 1.45V.

AND - the RMS value in Channel 1 is less than 850 mV.

If any of the four conditions in this example is not satisfied, the test will FAIL.

Whether the test PASSES or FAILS, the oscilloscope can, if the user wishes, be set to perform any or all of the following actions:

- Stop the acquisition.
- Make a screen dump.
- Store a trace to Memory D.
- Store selected traces to the memory card.
- Emit a "beep".
- Send a pulse from the rear panel accessory port.

The mask envelope can also be generated inside the oscilloscope.

PASS/FAIL DISPLAY

Accessing the display

1. Press the **Parameters** button (15) to activate the pulse parameters display mode (Figure 58).

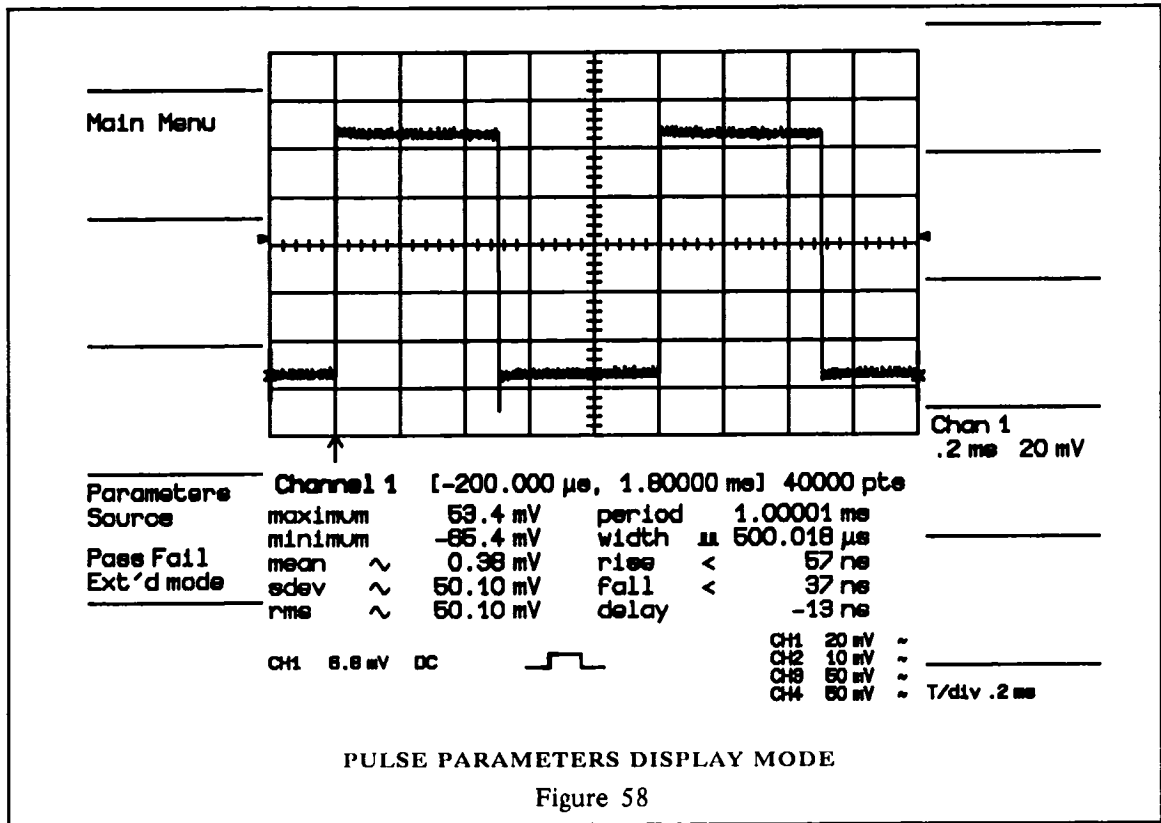

2. Press the **Pass Fail Ext'd Mode** button (9) to access the Pass/Fail display.

3. Press the Set up Pass Fail Ext'd button (8) in the Menu Field (II) to call up the Setup Menu (Figure 59).

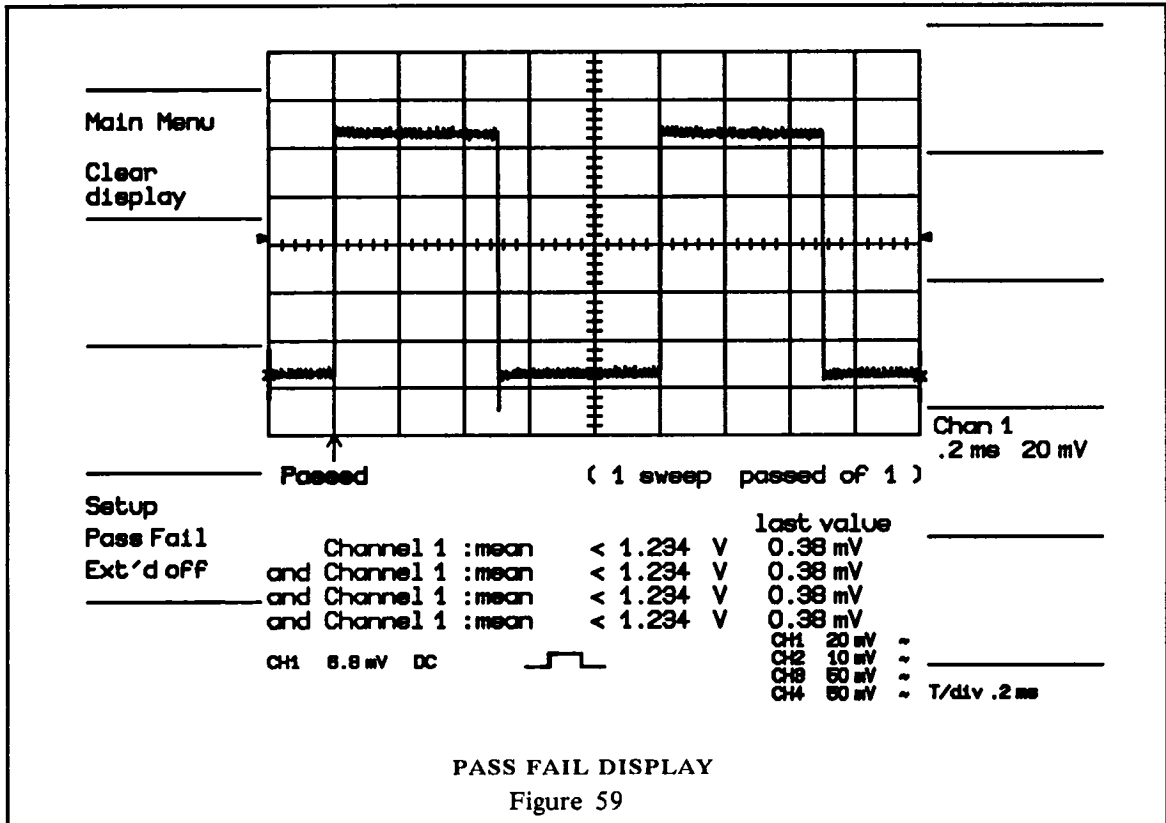

At this point, make sure that the upper-left field on the screen is set to either PASS or FAIL. If this field is set to SHOW, use buttons (2) and (3) or the Reference knob (48) to select the field, then use buttons (4) or (5) or the Difference knob (46) to set the test type to either PASS or FAIL.

- Press the **Return** button (10) to enter the PASS/FAIL display (Figure 60)

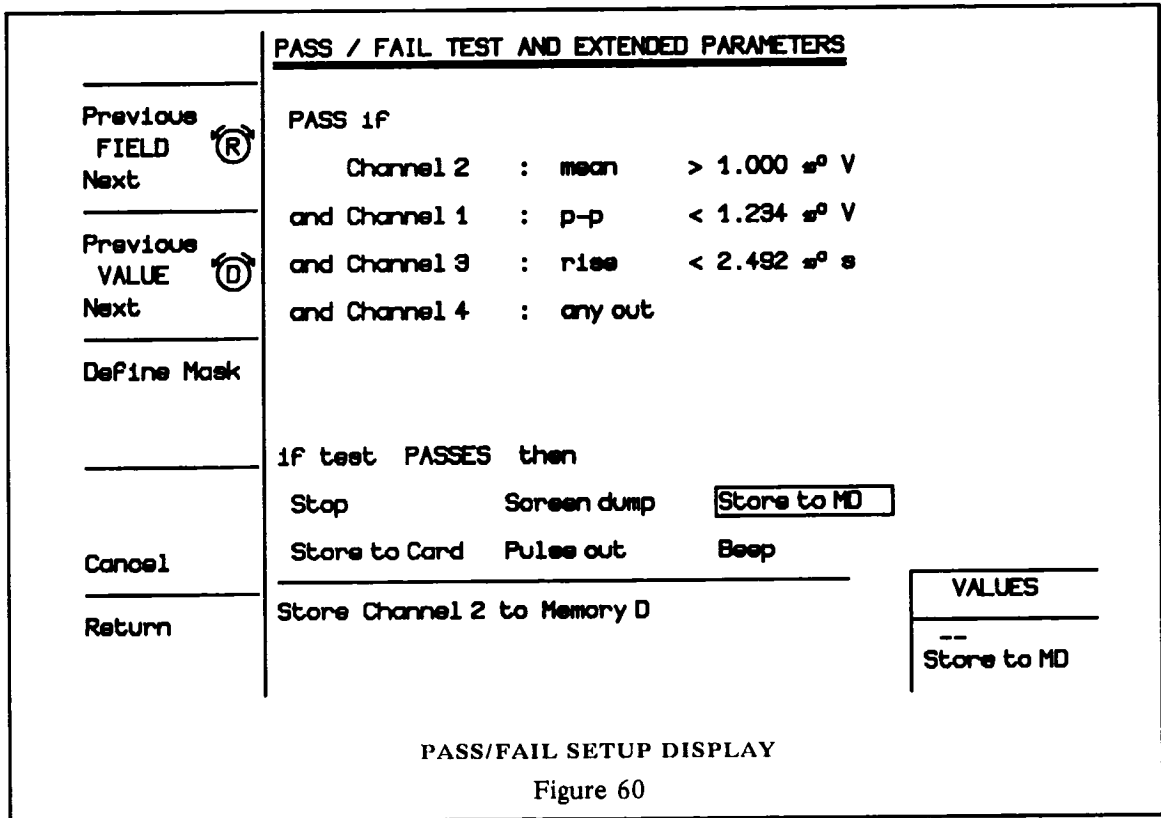

Description of display

The test conditions are listed below the grid.

A pair of cross-hair cursors appear on the currently selected waveform. The test may be performed on any region of interest by simply positioning the cursors, using the **Reference** (48) and **Difference** (46) knobs. The cursors define the left- and right- hand boundaries of the area on which the test will be carried out.

Pressing the **Tracking** button (47) causes the Difference cursor to track the Reference cursor at a fixed interval as determined by the Difference control. A horizontal bar on the top line of the grid indicates that tracking is on. Its length shows the tracking interval.

Note: The status of the test (Passed or Failed) is shown on the lower left-hand corner of the grid. Any undefined parameter in a test condition forces the condition to be "FALSE". For example, if the test condition was "Pass if Channel 1 :freq > 1 kHz", and if Channel 1 was not showing at least one full period of the signal, the frequency parameter would be undefined and the test would fail.

The **last value** column on the display indicates the value of each test parameter after completion of the last acquisition or processing operation.

The **Clear Display** button (3) restarts the test. Also, any change in the acquisition settings of the source waveform will cause the test to restart.

The **Setup Pass Fail** button (8) calls up the setup menu of the test conditions (see next section).

The **Pass Fail Ext'd off** button (9) exits the menu and takes you back to the standard pulse parameters menu.

PASS/FAIL SETUP

Selecting the test conditions

Now that you have accessed the PASS/FAIL setup menu you can:

1. Set up to four test conditions.
2. Define these conditions as being PASS or FAIL conditions.
3. Define the actions to be performed after the test passes or fails.

The first field on the upper left-hand corner of the menu sets up the PASS or FAIL condition. Use buttons (2) and (3) or the **Reference** knob (48) to select the field. Use buttons (4) and (5) or the **Difference** knob (46) to select PASS or FAIL.

Using the same controls, select the test conditions:

- The waveform source (Channel 1, Memory D, Function F, etc.).
- The adequate parameter (see parameter list Table 4).
- The "<" or ">" sign to define a "smaller than" or "greater than" condition.
- The reference value.

Selecting the actions to be performed

The next field selects the case (PASS or FAIL) in which you wish to induce an action. The last fields allow you to select up to six actions you wish the oscilloscope to perform:



- Stop the acquisition.
- Send the source waveform to a hardcopy device.
- Store the source waveform of the first test condition to Memory D.
- Store selected waveforms to optional memory card.
- Emit a "beep".
- Send a pulse from the **Accessory Control** port (69) on the rear panel.

Generating the Mask

The tolerance mask must be located in Memory C and can be generated in one of the following ways:

1. The waveform can be imported from a computer using the MC:WAVEFORM remote command to send the data to Memory C.
2. The waveform can be imported from the memory card if the oscilloscope is equipped with that option.
3. If the oscilloscope is equipped with WP01, the waveform can be generated using the Extrema function and storing the result in Memory C.
4. Any waveform in the oscilloscope can be converted into a tolerance mask using the built-in mask generator in the instrument. The following paragraphs describe this routine.

In the PASS/FAIL setup menu press the **Define Mask** button (6) to enter the mask setup (Figure 61).

Define Mask in Memory C	
Previous FIELD 	Source: Channel 1
Next	Horizontal tolerance: -0.2 to 0.2 div
Previous VALUE 	Vertical tolerance: -0.5 to 0.5 div
Next	
Make Mask	
Pass Fail Autosetup	
Cancel	
Return	Push Make Mask button to convert waveform in Channel 1 into Mask in Memory C

VALUES
Expand A
Expand B
Memory D
Function E
Function F
TO
Channel 4

MASK SETUP
Figure 61

The first field in the mask setup allows you to set up the source waveform. The following fields allow you to set the Horizontal and Vertical tolerances around the source trace.

Use buttons (2) and (3) or the **Reference** knob (48) to select the field. Use buttons (4) and (5) or the **Difference** knob (46) to scroll through the available options in the field.

Once you have set the tolerances, press the **Make Mask** button (7) to generate the mask, then the **Return** button (10) to exit the setup menu. You can also press the **Cancel** button (8) to go back to your previous mask settings.

The mask can be displayed on the screen by pressing the Trace On/Off button (57) (Figure 62).

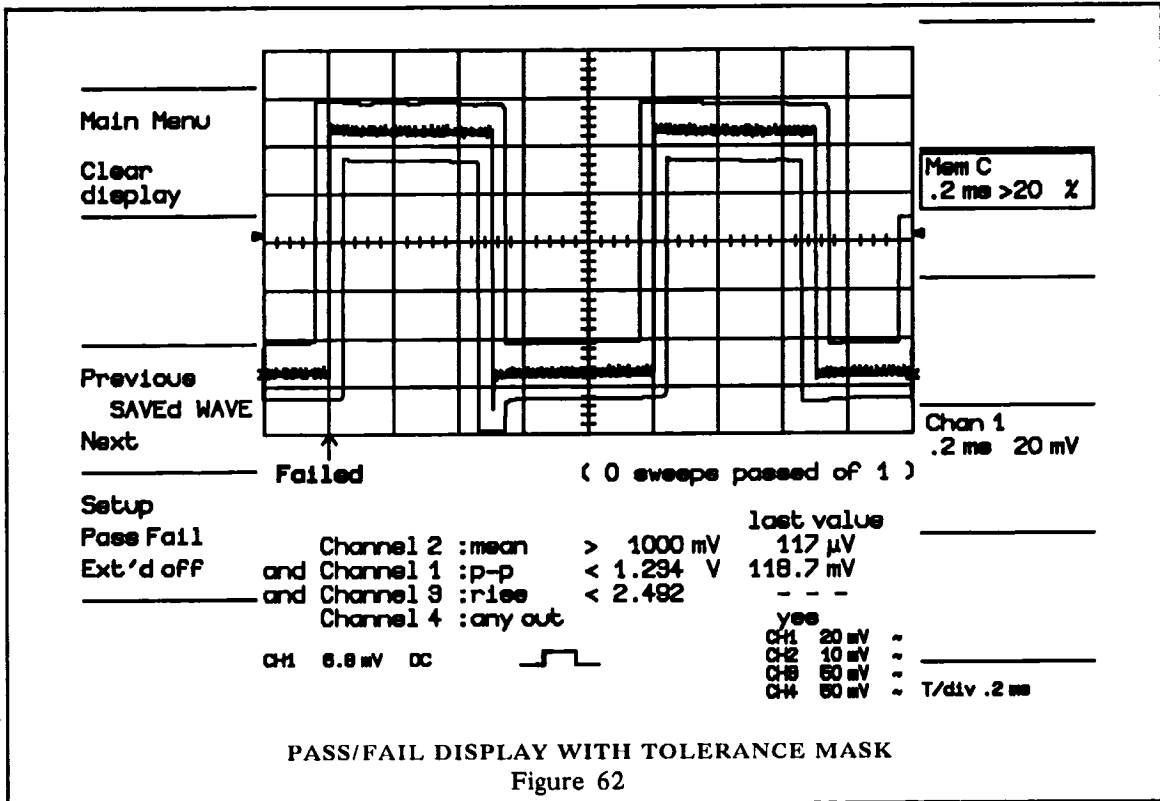

TEST PARAMETERS LIST

PARAMETER	EXPLANATION
all points in amplitude	This parameter is set to YES when all the source points are inside. Top minus the base.
any points out	This parameter is set to YES when at least one source point is outside the mask in Memory C.
area	Sum of sampled values between the cursors times the duration of a sample.
base	Lower of two most probable states. This is characteristic of rectangular waveforms and represents the lower most probable state determined from the statistical distribution of data point values in the waveform.
cycles	Number of pairs of transitions in the same direction.
delay	Time from trigger to the midpoint of the first transition.
duty cycle	Average duration above midpoint value as a percentage of period.
fall time	Duration of the pulse waveform's falling transition from 90% to 10%, averaged for all falling transitions between the cursors.
first	Time from trigger to first (leftmost) cursor.
frequency	Reciprocal of period.
last	Time from trigger to last (rightmost) cursor.
maximum	Maximum value of the trace between the cursors.
mean	Average or DC level of the waveform. If the waveform is periodic, it is computed over an integral number of periods.
minimum	Minimum value of the trace between the cursors.
overshoot negative	Base value minus the minimum sample value, expressed as a percentage of the amplitude.
overshoot positive	Maximum sample value minus the top value, expressed as a percentage of the amplitude.
peak-to-peak	Difference between the maximum and the minimum values.
period	Time of a full cycle averaged for all full cycles between the cursors.
points	Number of points between the vertical cursors.
rise time	Duration of the pulse waveform's rising transition from 10% to 90%, averaged for all rising transitions between the cursors.
root mean square	Square root of sum of squares, divided by number of terms. If the waveform is periodic, it is computed over an integral number of periods.
standard deviation	Square root of sum of squares of difference from mean, divided by number of terms. If the waveform is periodic, it is computed over an integral number of periods.
top	Upper of two most probable states. This is characteristic of rectangular waveforms and represents the higher most probable state determined from the statistical distribution of data point values in the waveform.
width	Width of the first pulse (either positive or negative), averaged for all similar pulses between the cursors.

Table 4

Information and Warning Symbols

If the number of points used is small, the statistical uncertainties in determining the base and top levels may be high and hence overall accuracy may be reduced.

The algorithm which determines the pulse waveform parameters is capable of detecting certain situations where the mathematical formulae may be applied but the results obtained must be interpreted with caution. In these cases the name of the parameter and its value are separated on the screen by a graphic symbol. The symbols and their meanings are indicated in Figure 63.

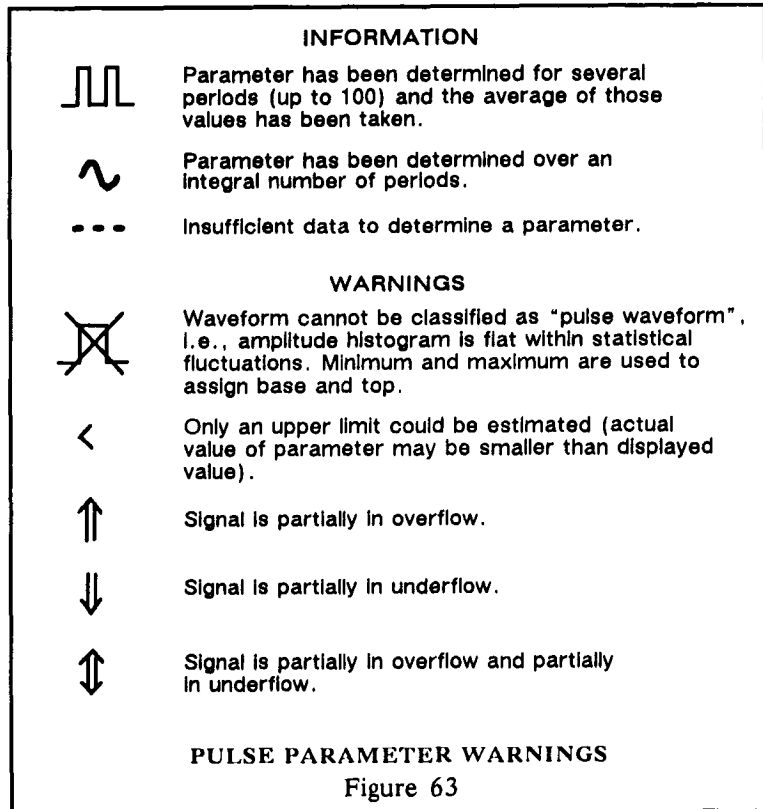

EXTENDED PULSE PARAMETERS

The Extended Parameters feature allows the user to choose any four parameters he would like to display, among a list of xx parameters. The parameters can be taken from different source waveforms. For example, the following four parameters can be displayed all at once and will update for every acquisition:

Channel 1: Frequency
 Channel 2: Rise Time
 Function F: RMS
 Memory D: Fall Time

EXTENDED PARAMETERS Accessing the display DISPLAY

1. Press the Parameters button (15) to activate the pulse parameters display mode (Figure 64).

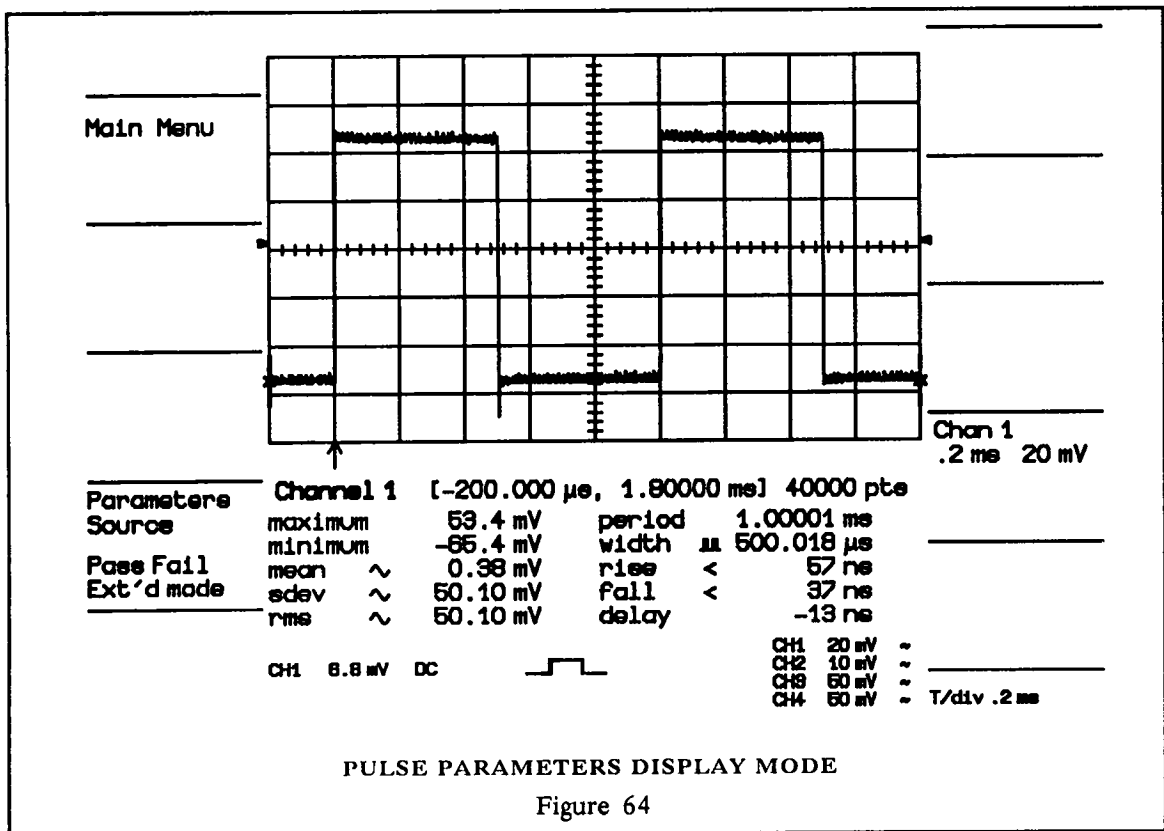

2. Press the **Pass Fail Ext'd** mode button (9) to access the Extended Parameters display.
3. Press the **Setup Pass Fail** button (8) in the Menu Field (II) to call up the Setup Menu (Figure 65).

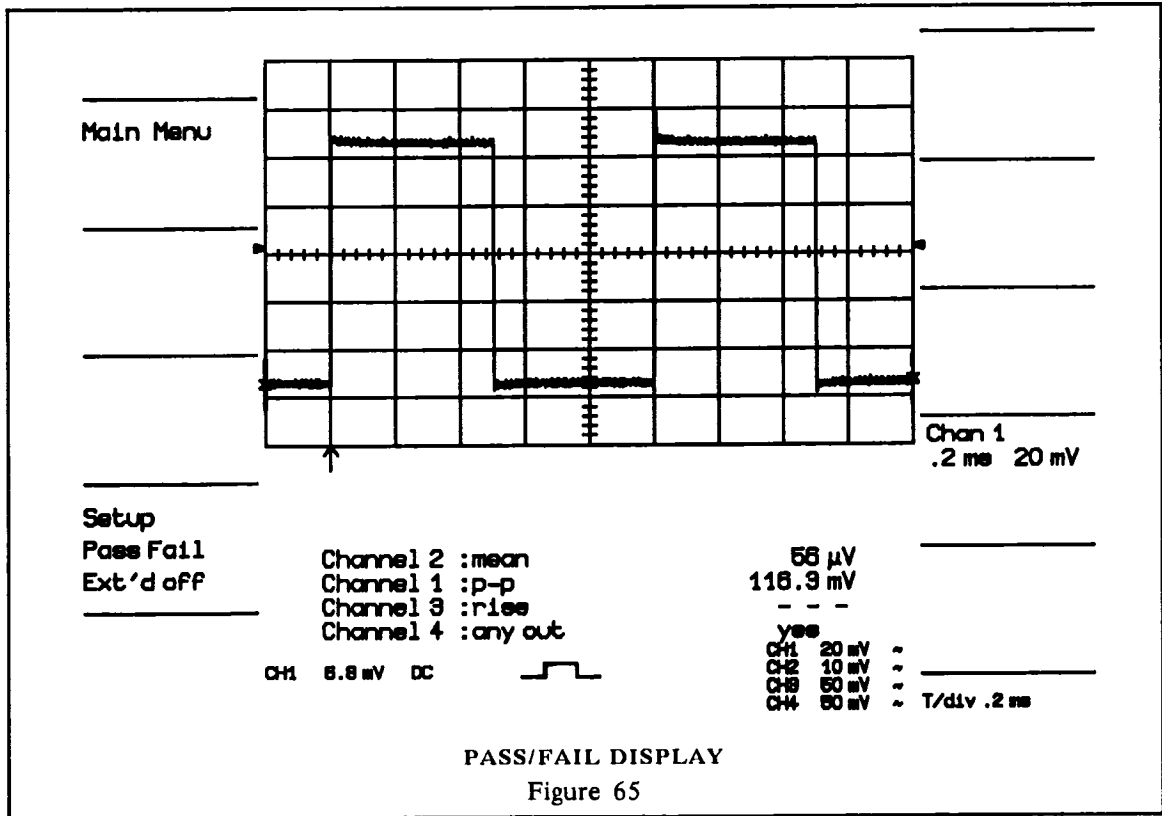

At this point, make sure that the upper-left field on the screen is set to SHOW. If this field is set to either PASS or FAIL, use buttons (2) and (3) or the **Reference** knob (48) to select the field, then use buttons (4) or (5) or the **Difference** knob (46) to set the test type to SHOW.

4. Press the Return button (10) to enter the Extended Parameters display (Figure 66)

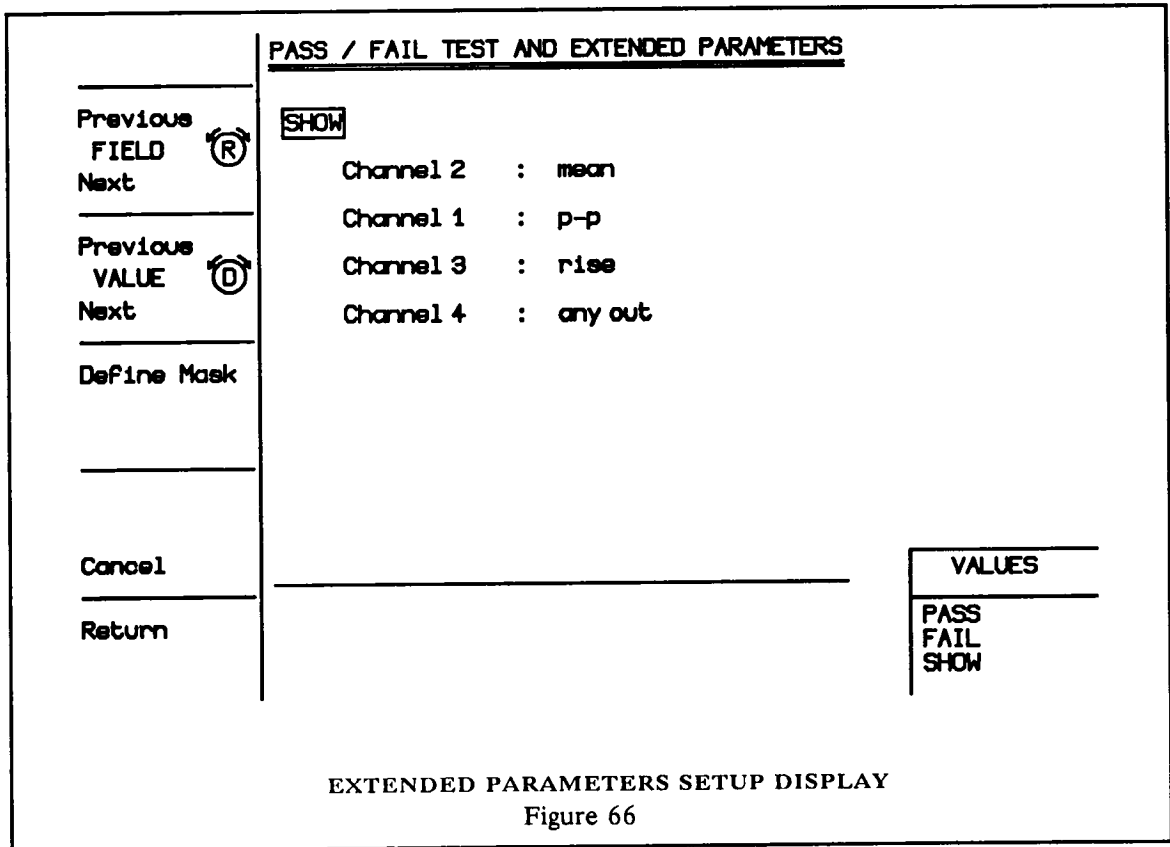

Description of display

The extended parameters are listed below the grid.

A pair of cross-hair cursors appear on the currently selected waveform. Measurements may be performed on any region of interest by simply positioning the cursors, using the Reference (48) and Difference (46) knobs. The cursors define the left- and right-hand boundaries of the area on which measurements will be made.

Pressing the Tracking button (47) causes the Difference cursor to track the Reference cursor at a fixed interval as determined by the Difference control. A horizontal bar on the top line of the grid indicates that tracking is on. Its length shows the tracking interval.

The **Setup Pass Fail Ext'd** button (8) calls up the setup menu of the Extended Parameters.

The **Pass Fail Ext'd off** button (9) exits the menu and takes you back to the standard pulse parameters menu.

EXTENDED PARAMETERS SETUP

Once you have accessed the Extended Parameters setup menu, make sure that the first field is set to **SHOW** (Figure 66). The following fields allow you to choose the source waveform and the type of parameter measurement (see parameter list Table 4).

Press the **Return** button (10) to exit the menu or the **Cancel** button (9) to go back to your previous settings.

EXTENDED PARAMETERS LIST

PARAMETER	EXPLANATION
all points in amplitude	This parameter is set to YES when all the source points are inside. Top minus the base.
any points out	This parameter is set to YES when at least one source point is outside the mask in Memory C.
area	Sum of sampled values between the cursors times the duration of a sample.
base	Lower of two most probable states. This is characteristic of rectangular waveforms and represents the lower most probable state determined from the statistical distribution of data point values in the waveform.
cycles	Number of pairs of transitions in the same direction.
delay	Time from trigger to the midpoint of the first transition.
duty cycle	Average duration above midpoint value as a percentage of period.
fall time	Duration of the pulse waveform's falling transition from 90% to 10%, averaged for all falling transitions between the cursors.
first	Time from trigger to first (leftmost) cursor.
frequency	Reciprocal of period.
last	Time from trigger to last (rightmost) cursor.
maximum	Maximum value of the trace between the cursors.
mean	Average or DC level of the waveform. If the waveform is periodic, it is computed over an integral number of periods.
minimum	Minimum value of the trace between the cursors.
overshoot negative	Base value minus the minimum sample value, expressed as a percentage of the amplitude.
overshoot positive	Maximum sample value minus the top value, expressed as a percentage of the amplitude.
peak-to-peak	Difference between the maximum and the minimum values.
period	Time of a full cycle averaged for all full cycles between the cursors.
points	Number of points between the vertical cursors.
rise time	Duration of the pulse waveform's rising transition from 10% to 90%, averaged for all rising transitions between the cursors.
root mean square	Square root of sum of squares, divided by number of terms. If the waveform is periodic, it is computed over an integral number of periods.
standard deviation	Square root of sum of squares of difference from mean, divided by number of terms. If the waveform is periodic, it is computed over an integral number of periods.
top	Upper of two most probable states. This is characteristic of rectangular waveforms and represents the higher most probable state determined from the statistical distribution of data point values in the waveform.
width	Width of the first pulse (either positive or negative), averaged for all similar pulses between the cursors.

Table 4

Information and Warning Symbols

If the number of points used is small, the statistical uncertainties in determining the base and top levels may be high and hence overall accuracy may be reduced.

The algorithm which determines the pulse waveform parameters is capable of detecting certain situations where the mathematical formulae may be applied but the results obtained must be interpreted with caution. In these cases the name of the parameter and its value are separated on the screen by a graphic symbol. The symbols and their meanings are indicated in Figure 67.









INFORMATION	
	Parameter has been determined for several periods (up to 100) and the average of those values has been taken.
	Parameter has been determined over an integral number of periods.
	Insufficient data to determine a parameter.
WARNINGS	
	Waveform cannot be classified as "pulse waveform", i.e., amplitude histogram is flat within statistical fluctuations. Minimum and maximum are used to assign base and top.
	Only an upper limit could be estimated (actual value of parameter may be smaller than displayed value).
	Signal is partially in overflow.
	Signal is partially in underflow.
	Signal is partially in overflow and partially in underflow.
PULSE PARAMETER WARNINGS	

Figure 67

**MAINS VOLTAGE
SELECTION (67)**

Ensure that the mains voltage for your area corresponds to the mains voltage set on the 9424, i.e. the green peg on the **Voltage Selector** plate (67) should be set to 115 V or 220 V as required. To adapt the oscilloscope to the other voltage, first remove the power cable and unscrew the **Voltage Selector** plate.

Pull the green voltage board out of its socket using a pair of flat pliers. Shift the board left (for 115 V) or right (for 220 V) by two contacts and plug it back into its socket. Screw the **Voltage Selector** plate back into position. The green peg should now be next to the required voltage value.

FUSE PROTECTION

The power supply of the oscilloscope is protected against short circuits and overload by means of two T(slow) 3.15 A/250 V fuses. The fuses are located beside the mains plug.

Remove the power cable before changing or inspecting a fuse. Open the fuse box with a small screwdriver by inserting it under the plastic cover from the right-hand side (just next to the mains connector) and prying it open.

Each fuse is retained by an individual fuse holder. To take a fuse holder out, release the retaining latch using the screwdriver, pushing up for the upper holder or down for the lower holder. Slide the holder with its fuse out.

The fuse and its holder are replaced by simply inserting them back into the corresponding hole until they are latched into place. They can be inserted only if the retaining latch points toward the center between the two fuses. Latch the fuse box cover securely into place.

POWER SWITCH (66)

Power for the operation of the instrument is interrupted or established with the **Power** switch (66). The power is ON when the switch is pressed in, and OFF when the switch is not pressed in.

**ACCESSORY POWER
CONNECTORS (73)**

Two LEMO RA 0304 NYL connectors have been provided to permit use of FET type probes with the oscilloscope. These connectors provide output voltages of + 5 V, ± 15 V and GND connection and are suitable for most FET probes.

The maximum output current per connector must be limited to 150 mA for each of the three voltages.

GPIB AND RS-232-C PORT SELECTION (70)

The oscilloscope's rear-panel thumbwheel switches are used to set addresses for programmed or remote oscilloscope operation. Addresses 0-30 define the oscilloscope's address when using the GPIB (IEEE-488) port. Any one of the addresses 31-99 selects the RS-232-C port.

Note: The address set on the thumbwheel switch is read by the processor when the unit is powered up. This is the address which appears in the Auxiliary Setups menu. Each time the address is changed, the oscilloscope should be switched off and on again.

RS-232-C CONNECTOR (68)

The RS-232-C port (68) can be used for remote oscilloscope operation, as well as for direct interfacing of the oscilloscope to a digital plotter or printer to produce hard copies of displayed waveforms and other screen data.

While a plotter unit is connected to the oscilloscope, its RS-232-C port can be computer controlled from a host computer via the GPIB port. The oscilloscope's built-in digital plotter and printer drivers allow hard copies to be made without an external computer.

RS-232-C connector pin assignments:

Pin #		Description
2	T x D	Transmitted Data (from the oscilloscope)
3	R x D	Received Data (to the oscilloscope)
4	RTS	Request To Send (always on) (from the oscilloscope)
5	CTS	Clear To Send (to the oscilloscope) When TRUE, the oscilloscope can transmit. When FALSE, transmission stops. Used for oscilloscope output hardware handshake.
20	DTR	Data Terminal Ready (from the oscilloscope) Always TRUE.
6	DSR	Data Set Ready (to the oscilloscope)
1	GND	Protective Ground
7	SIG GND	Signal Ground

This corresponds to a DTE (Data Terminal Equipment) configuration.

ACCESSORY CONTROL (69)

This connector is used for factory testing the instrument.

BNC CONNECTOR (62) to (65)

Four BNC connectors are available on the rear panel of the oscilloscope:

External CK input (62)

Sampling CK output (63)

Trigger out (64)

Trigger veto (65)

EXTERNAL CK INPUT (62)

The external clock input allows waveforms to be sampled with a user-defined clock when the oscilloscope is in the "External Clock" mode.

It is a DC coupled $50\ \Omega$ impedance input. The maximum input frequency is 100 MHz. The recommended input signal is symmetrical around 0 V with an amplitude of ± 400 mV peak (max. ± 1 V peak). The risetimes and falltimes must be less than 10 nsec.

SAMPLING CK OUTPUT (63)

The sampling clock output delivers a continuous signal at half the sampling frequency. During acquisition the signal is sampled at each transition of this signal. The output should be terminated on $50\ \Omega$ to GND. This is a DC coupled, high impedance output which generates 0 mA for logic "0" state and -16 mA for logic "1" state corresponding to 0 mV and -800 mV respectively on a $50\ \Omega$ load. The output amplitude is limited to -1.4 V for all other loads.

The risetime and falltime are less than 1.5 nsec.

TRIGGER OUT (64)

A negative pulse of variable width is generated when a trigger is accepted. This output should be terminated on $50\ \Omega$ to GND. The signal amplitude is 0 mV when quiescent and -16 mA after a trigger has been accepted (or -800 mV into $50\ \Omega$).

TRIGGER VETO (65)

The trigger veto input/output can be used to synchronize the acquisition of several 9424s. It should be connected to a $50\ \Omega$ cable terminated at each end by $50\ \Omega$ to GND.

The output, at a high state when the oscilloscope is ready for a trigger, goes negative when the instrument is busy, disabling all the oscilloscopes connected to the same veto line. If this line is changed from low to high via external control, all the oscilloscopes connected to the veto line are simultaneously enabled.

The trigger veto is DC coupled, high impedance. It generates 2 mA when a trigger can be accepted and -16 mA when the oscilloscope is busy, that is 50 mV and -400 mV respectively on a 25 Ω load.

The amplitude of the signal is limited to ± 1.4 V. The risetime and falltime are less than 3 nsec.

Triggers will be refused if the trigger veto level is less than -300 mV, and accepted for levels greater than -100 mV.

EXTERNAL TRIGGER (65) On the 9424E oscilloscope with External trigger option, the Trigger Veto has been replaced by the External Trigger input. The input is 50 Ω terminated and has a *maximum* voltage range of ± 0.8 V.

Warning: voltages outside of this range may damage the External Trigger circuitry.

RESET (71)

This button is activated by pressing it with a small screwdriver or a similar tool, and keeping it pressed in until a buzzer sounds.

A reset is only needed if a catastrophic failure of the instrument's software occurs. In many cases, it is sufficient to turn off the power and turn it on again.

The **Reset** button not only reboots the instrument (exactly as in the power-up sequence) but also clears the internal non-volatile RAM. Thus, stored front-panel setups and traces are lost.

The purpose of this section is to help the user make basic measurements using the 9424, and to provide an overview of the wide range of measurement capabilities offered by LeCroy oscilloscopes. While you may already be familiar with traditional oscilloscope operation, this outline will help to acquaint you with some of the 9424's powerful features.

In the following section we have sometimes chosen to set all acquisition parameters from the Panel Status menu; however, it is not necessary to be in this menu to change the front-panel settings. In most cases, the Abridged Panel Status field (VII) will provide all the necessary information.

WAVEFORM ACQUISITION

Simple Measurements using the Probe Calibrator Signal

Switching on the 9424

- 1) Connect the oscilloscope to the mains using the cable provided. Check that the mains voltage settings on the oscilloscope correspond to the available mains voltage.
- 2) Press the **Power** switch on the rear panel to switch the oscilloscope on. Notice that when the instrument is switched on, it is in the root menu, i.e. the **Menu** field (II) is blank apart from the option **Main Menu** next to button (2).

Example 1: Auto-setup

Connecting the Probe Calibrator Signal

- 1) Connect the P9020 probe connector to the **Channel 1** input (23).
- 2) Connect the probe's grounding clip to lug (22) and touch the tip to lug (21).
- 3) Set the **Channel 1 Coupling** to **AC 1 M Ω** or **DC 1 M Ω** , using the channel select buttons (24) and the signal coupling buttons (26).
- 4) Set **Channel 1** trace to **ON** and switch all the other traces off, using buttons (56) to (60).

Auto-setup

- 5) Press **Auto-setup**, button (61). The auto-setup button automatically scales the time-base, trigger and sensitivity settings to provide a stable display.

Auto-setup

You can use the auto-setup facility for repetitive signals if:

- 2 mV < amplitude < 8 V
- Frequency > 50 Hz
- Duty cycle > 0.1%

Example 2: Manual Setup

We will now repeat the same recording of the probe calibrator signal except that this time the oscilloscope will be set manually.

Connecting the signal

- 1) Connect the P9020 probe connector to **Channel 1** input (23).
- 2) Connect the probe's grounding clip to lug (22) and touch the tip to lug (21).

Selecting a channel

- 3) Use buttons (56) to (60) to set **Channel 1** on and all the other traces off.
- 4) Use the trigger **Mode** button (31) to set the oscilloscope to **Single** and **Status Trig'd**.
- 5) Set **Channel 1 Coupling** to **DC 1 M Ω** using the channel select buttons (24) and the coupling buttons (26).

Entering the Panel Status menu

- 6) The oscilloscope is in the root menu when it has just been switched on. Press **Main Menu**, button (2).
- 7) Press **Panel Status**, button (2).

Adjusting the vertical parameters

- 8) Set **Channel 1 Fixed Volts/Div** to 10 mV/div (37).
- 9) Adjust the **Channel 1 Var** vernier (38) to get a **Total V/div** of 13.0 mV/div.
- 10) Set **Channel 1 Offset** to -50 mV (39).
- 11) Set **Bandwidth Limit** to OFF (20).

Setting the time base

- 12) Set **Time/Division** control (45) to 0.5 msec. Note that at this time-base setting, **Interleaved Sampling (RIS)** is OFF.

Adjusting the trigger

- 13) Set the Trigger Source to Chan 1 (27).
- 14) Use Trigger Level knob (42) to set the trigger level to 0 mV.
- 15) Set the Trigger Coupling to AC (29).
- 16) Use Trigger Delay knob (40) to set 15% pretrigger.
- 17) Set the Trigger Slope to Pos (34).
- 18) Set the Trigger Mode to Auto (31).

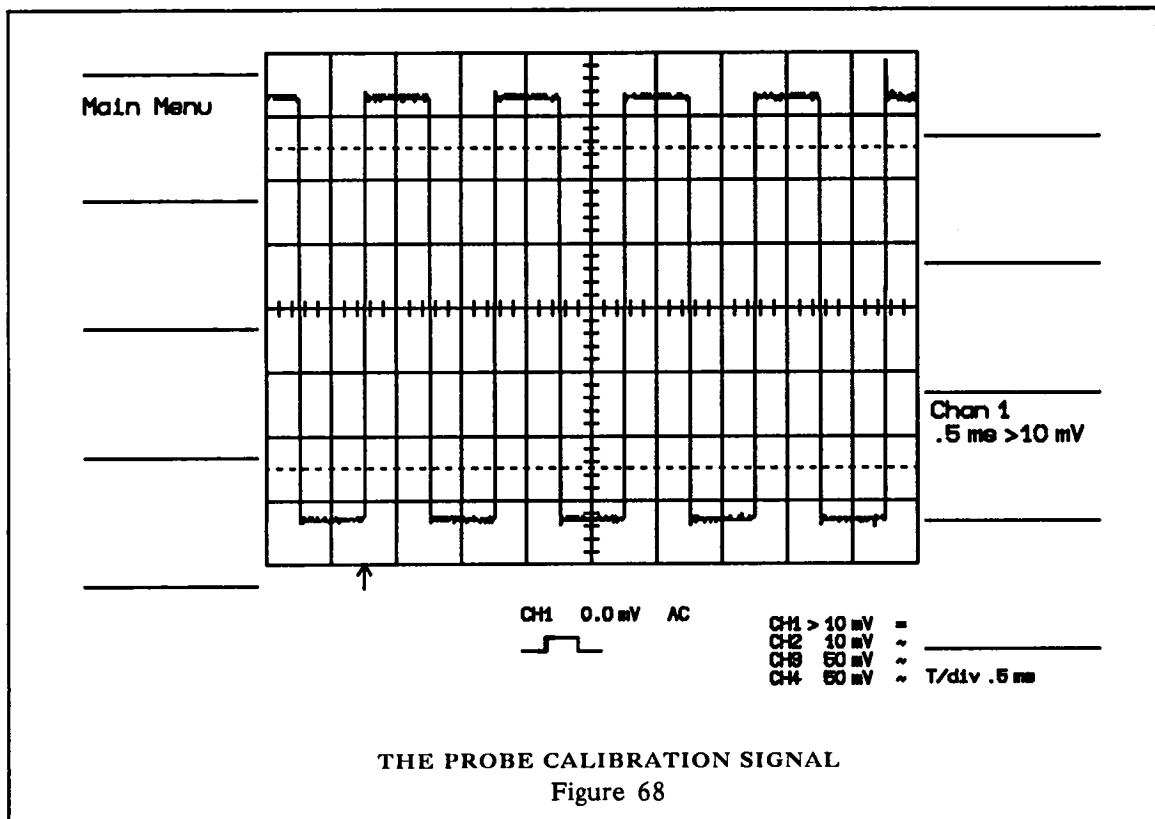

Miscellaneous

- 19) Return to the Main Menu by pressing the **Return** button (10).
- 20) Set the oscilloscope to **Single Grid** mode using button (14).

The resulting display is shown in Figure 68.

Note: The $\times 10$ attenuation factor of the probe can be taken into account for all readings by setting this factor for Channel 1 in the Panel Status menu.

Example 3: How to Check the Probe Calibrator

The P9020 probe has a $\times 10$ attenuation factor. Thus, the 1 V, 1 kHz output calibration signal is displayed with a total amplitude of approximately 7.7 divisions at a **Total V/div** setting of 13.0 mV/div. If there is over- or under-shoot, adjust the probe compensation trimmer, located on the barrel of the P9020, for a clean square-wave contour. For further adjustments of the probe, consult the probe manual.

Signal Acquisition Summary

Connect the signal
Select an acquisition channel
(Enter the panel status menu)
Adjust the vertical parameters
Adjust the time base
Adjust the trigger

or

(for repetitive waveforms only)

Connect the signal
Select the signal coupling
Select a channel
Press Auto-setup
Adjust as desired

Following are some further examples of setting up the oscilloscope for various types of signals.

Example 4:
Random Interleaved Sampling
for Fast Repetitive Signals
 (Period 10 to 100 nsec)

Connecting the signal

- 1) Connect a fast sine wave generator providing an output signal whose period is between 10 and 100 nsec (i.e. frequency between 10 and 100 MHz) to the **Channel 2** BNC input (25).

Selecting a channel

- 2) Use buttons (56) to (60) to set **Channel 2** on and all the other traces off.
- 3) Set **Channel 2 Coupling** to **DC 50 Ω** using the channel select buttons (24) and the coupling buttons (26).
- 4) Set **Bandwidth Limit** to **OFF** (20).
- 5) Press **Auto-setup** (61).

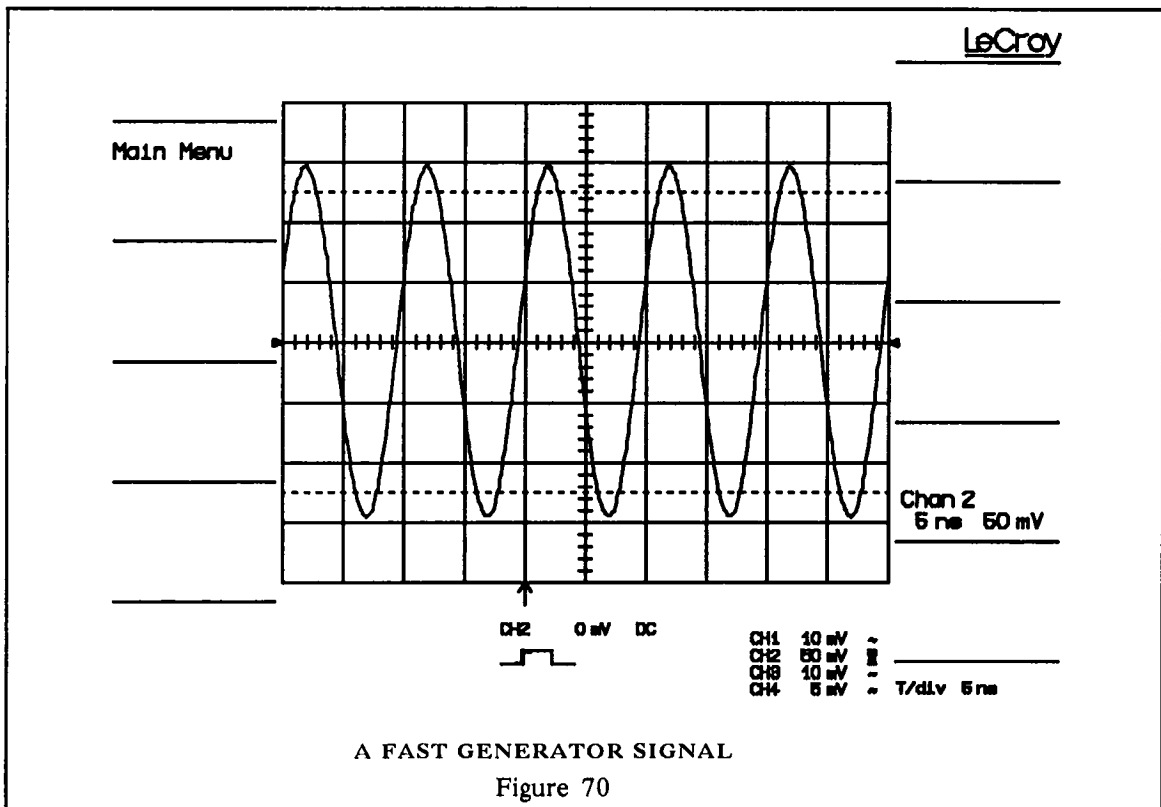

Adjusting the time base

- 6) Set the **Time/Division** control (45) to 5 nsec/div . Notice that at this setting **Interleaved Sampling (RIS)** is ON and cannot be switched OFF.

Adjusting the trigger

- 7) Use **Trigger Delay** knob (40) to set the vertical arrow four divisions to the right of the lower left edge of the grid (40% pretrigger).

Miscellaneous

- 8) Set the oscilloscope to **Single Grid** mode using button (14). A typical display is shown in Figure 70.

Example 5: Single-shot Acquisitions (Pulse 100 nsec Wide)

Connecting the signal

- 1) Connect the signal from a pulse generator to the **Channel 1 BNC input (23)**. The pulse generator should be free-running during the initial setting up of the oscilloscope. It must be set to provide a pulse 100 nsec wide with an amplitude of your choice.

Selecting an acquisition channel

- 2) Set **Channel 1** to ON and all other traces off (56) to (60).
- 3) Set **Channel 1 Coupling** to **50 Ω DC** using channel select buttons (24) and coupling buttons (26).

Entering the Panel Status Menu

- 4) In the main menu press **Panel Status**, button (2).

Adjusting the voltage sensitivity

- 5) Set **Channel 1 Fixed Volts/Div** as appropriate (37), i.e. to match the generator signal amplitude.
- 6) Adjust **Channel 1 Var vernier** (38) if necessary to match the generator.

Adjusting the time base

- 7) Set the **Time/Division** control (45) to 50 nsec/div .
- 8) Set **Interleaved Sampling** to OFF (44).

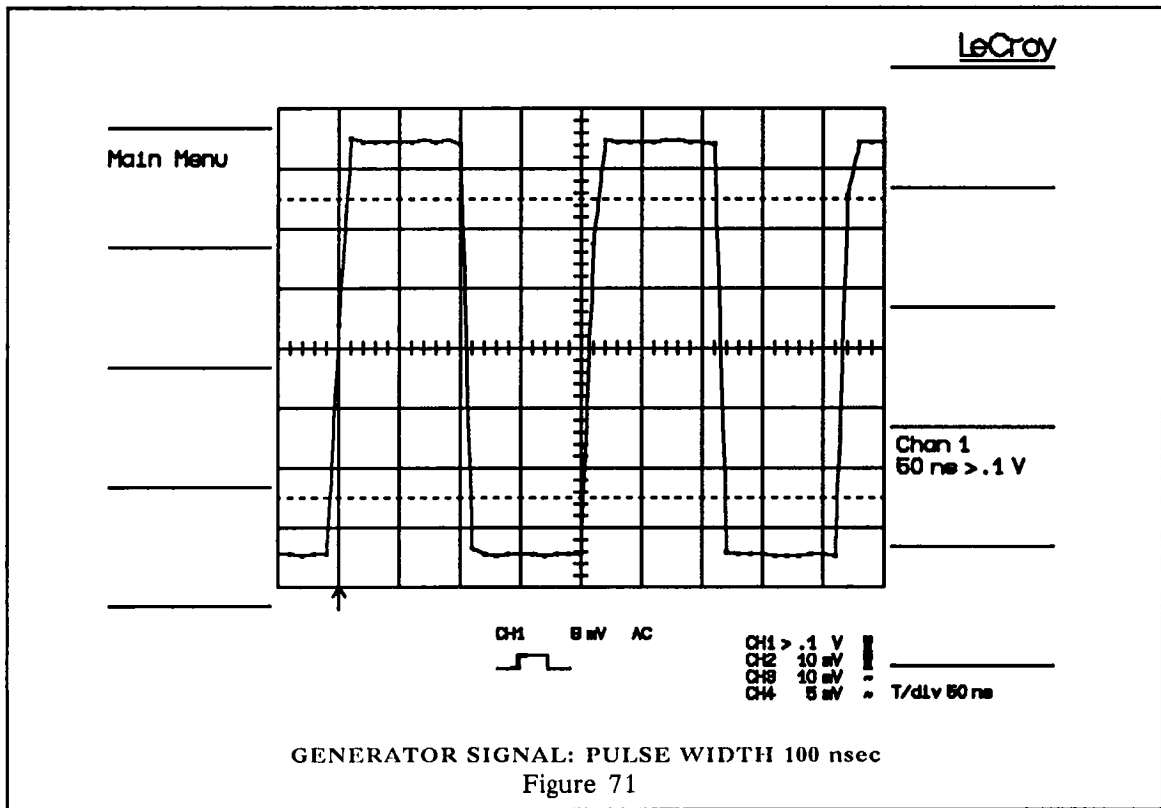

Adjusting the trigger

- 9) Use **Trigger Delay** knob (40) to set 10.0% pretrigger.
- 10) Set **Trigger Source** to **Chan 1** (27).
- 11) Use **Trigger Level** knob (42) to set the trigger to an appropriate level.
- 12) Set the **Trigger Coupling** to **AC** (29).
- 13) Set **Trigger Slope** to **Pos** (34).
- 14) Arm the trigger by setting the **Trigger Mode** (31) to **Single**.

Miscellaneous

- 15) Set the **Chan 1 Offset** to suit the input signal (39).
- 16) Set **Bandwidth Limit** to **OFF** (20).

- 17) Return to the Main Menu by pressing the **Return** button (10).
- 18) Set **Single Grid** mode using button (14).
- 19) When you see the signal on the screen, put the generator in external or manual trigger so that it is no longer free-running. Set **Trigger Mode** (31) to **Single** on the oscilloscope and trigger the signal source.

A typical display is shown in Figure 71.

**Example 6:
Roll Mode for Slow Signals
(1 Hz Sine Wave)**

Connecting the signal

- 1) Connect a 1 Hz signal source to the **Channel 2** BNC input connector (25) with an amplitude and offset of your choice.

Select an acquisition channel

- 2) Switch **Channel 2** on and all the other traces off using buttons (56) to (60).
- 3) Set **Channel 2 Coupling** to **DC 1 M Ω** using the channel select buttons (26) and the coupling buttons (24).

Entering the Panel Status menu

- 4) In the main menu press **Panel Status**, button (2).

Adjusting the voltage sensitivity

- 5) Set the **Channel 2** voltage sensitivity to suit the signal (37).
- 6) Adjust **Channel 2 Var** vernier (38) if necessary to match the generator.

Adjusting the time base

- 7) Set the time base to 1 sec/div (45).

Adjusting the trigger

- 8) Adjust the **Trigger Delay** to 50% pretrigger using knob (40).
- 9) Set the **Trigger Source** to **Chan 2** (27).
- 10) Use **Trigger Level** knob (42) to set the trigger to an appropriate level.
- 11) Set the **Trigger Coupling** to **AC** (29).
- 12) Set the **Trigger Slope** to **Pos** (34).
- 13) Set the **Trigger Mode** to **Norm** (31).

Miscellaneous

- 14) Adjust Channel 2 **Offset** to suit the signal (39).
- 15) Press **Return** button (10) to return to the Main Menu.
- 16) Set **Grid** mode to **Single** (14).

Resulting Display: A sine wave signal will be displayed, rolling from right to left across the screen. The display can be halted by pressing the **Single** button (31) when in **Normal** trigger mode. It also pauses at the end of an acquisition after a trigger is received.

Example 7:
Sequence Mode for
Segmenting Memories
into 5 Segments

Sequence mode is used for sequential recording of single events in segmented memory.

Connecting the signal

- 1) Connect the signal from a pulse generator to the **Channel 1** BNC input (23). For the purpose of this exercise set the pulse generator so that it is free-running while you set up the oscilloscope. It must be set to provide a positive-going pulse 100 nsec wide with an amplitude of your choice.

Selecting an acquisition channel

- 2) Switch **Channel 1** on and switch all the other traces off, using buttons (56) to (60).
- 3) Set Channel 1 **Coupling** to **DC 50 Ω** using the channel select buttons (24) and the coupling buttons (26).

Entering the Panel Status Menu

- 4) In the main menu, press **Panel Status**, button (2).

Adjusting the voltage sensitivity

- 5) Set Channel 1 **Fixed Volts/Div** as appropriate (37), i.e. to match the generator signal amplitude.
- 6) Adjust Channel 1 **Var** vernier (38) if necessary to match the generator.

Adjusting the time base

- 7) Set the **Time/Division** control (45) to 50 nsec/div.
- 8) Set **Interleaved Sampling** to **Off** (44).

Adjusting the trigger

- 9) Use knob (40) to adjust the **Trigger Delay** to 30% pretrigger.

- 10) Set **Trigger Source** to Chan 1 (27).
- 11) Use **Trigger Level** knob (42) to set the trigger level to 0 V.
- 12) Set the **Trigger Coupling** to AC (29).
- 13) Set **Trigger Slope** to Pos (34).
- 14) Select **Seqnce** trigger mode (31).

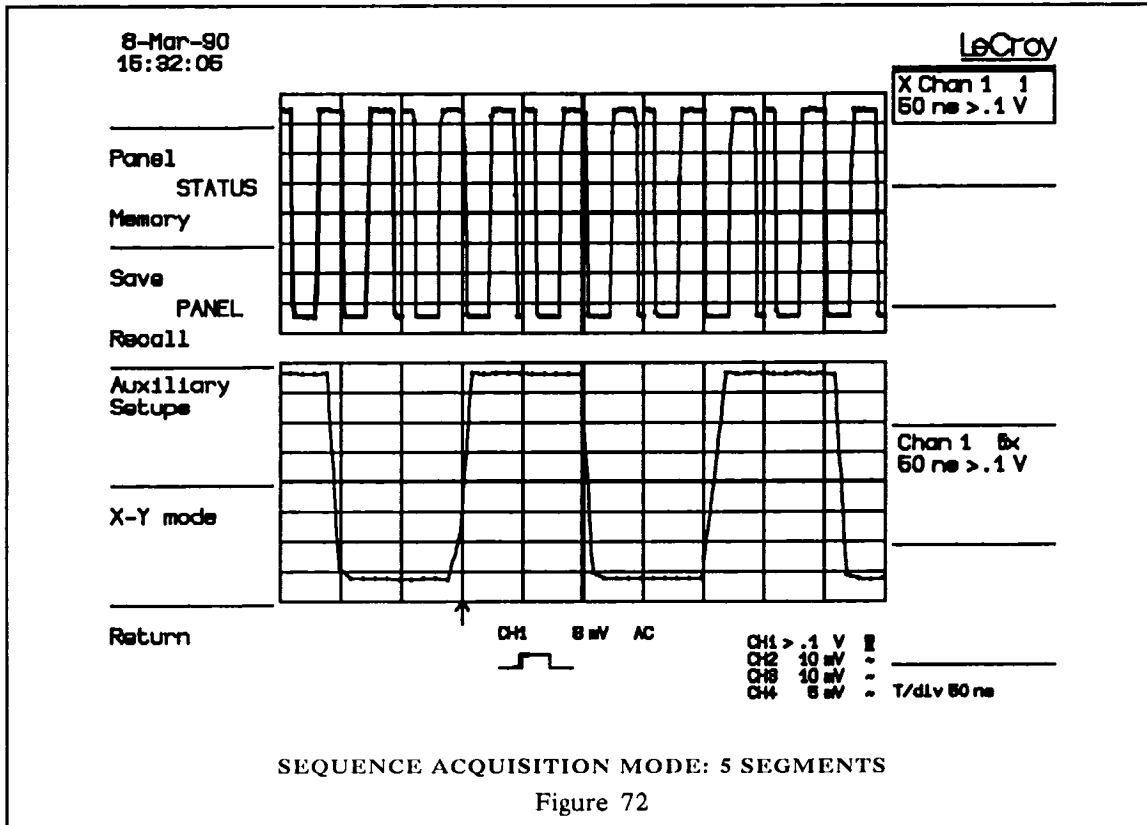

Setting the required number of segments

- 15) Press **Modify # Segments** button (6) as often as necessary to display the value 5 in the # Segments line.

Miscellaneous

- 16) Set the **Chan 1 Offset** to suit the input signal (39).
- 17) Set **Bandwidth Limit** to OFF (20).

- 18) Press **Return** button (10) to return to the Main Menu.
- 19) Set the **Grid** mode to **Dual** (14).
- 20) When you see the signal on the screen, put the generator in external or manual trigger so that it is no longer free-running. Set the **Trigger Mode** (31) to **Seqnce**. Now actuate the generator's external trigger a total of 5 times to generate 5 signals to be recorded.

At this point a compacted trace of 5 segments is displayed in the upper grid. Trace expansions **Expand A, B, C** and **D** may be used to display details of up to four selected segments. Waveform expansion is fully explained later in this chapter.

The resulting display is shown in Figure 72.

Sequence Mode for 10 Segments

To make a sequential recording of 10 single events, you need only modify the value displayed in the **# Segments** line of the Panel Status menu by pressing **Modify # Segments** button (6) until the value 10 appears in the **# Segments** line.

Keeping all other settings as above, generate 10 triggers. The resulting display shows the same waveform (Figure 73).

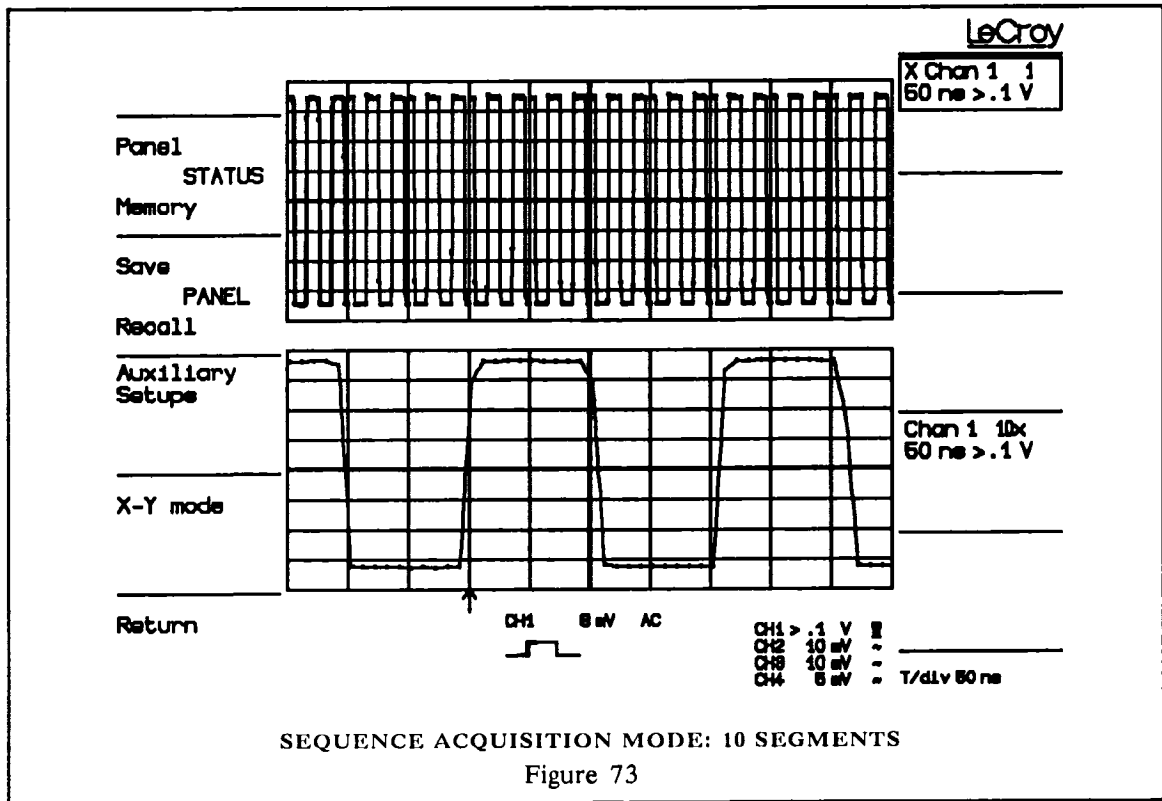

Sequence Acquisition Mode

Use sequence acquisition

- to capture multiple events
- when the time between successive events is short (minimum 100 μ sec)

SAVING AND RECALLING FRONT-PANEL SETUPS

Saving Front-panel Setups Entering the Save menu

- 1) Choose a front-panel setup to save. You can, for example, save one of the front-panel setups used above.
- 2) Press **Main Menu**, button (2), in the root menu.
- 3) Press the **Save Panel** (4) button.

Saving the setup

- 4) At this point a list of seven possible front-panel storage locations appears in the Menu field. Press the button adjacent to the storage location you wish to use, e.g. Panel 1. The complete front-panel settings are now stored.
- 5) Change some of the front-panel settings and follow the procedure outlined in steps 1 through 4 to store the new setup in Panel 2.

Recalling Front-panel Setups

Entering the Recall menu

- 1) Press **Main Menu**, button (2), in the root menu.
- 2) Press the **Recall Panel** (5) button.

Recalling the setup

- 3) At this point a list of the seven front-panel storage locations appears in the Menu field. The used locations are indicated with the word "from" followed by the date at which the front-panel setup was saved. The word "Empty" appears beside locations which have not yet been used.

Press button (2) which is adjacent to the Panel 1 storage location. The front-panel setup is now recalled.

- 4) Pressing button (3) in the **Recall Setup** menu will recall the second setup.

STORING AND RECALLING WAVEFORMS

Storing Waveforms

Storing Chan 1 into Function Memory C

Entering the Store Menu

- 1) Acquire a waveform on Channel 1 in **Single** trigger mode.
- 2) Press **Store**, button (1), to call up the Store Trace menu.

Choosing a waveform to store

- 3) A new menu appears offering the possibility of storing any of the sources, **Exp A**, **Exp B**, **Mem C**, **Mem D**, **Func E**, **Func F**, **Chan 1**, **2**, **3** or **4**. Press the button (59) which corresponds to **Chan 1**.

Storing the waveform

- 4) The menu also offers you the choice of storing **Chan 1** into **Mem C**, **Mem D**, **Func E** or **Func F**. Press button (2) which corresponds to **Mem C**. You have now stored Channel 1 into Function C. Note that Func C, D, E and F will automatically be set to the memory state if a waveform is stored into them.

Recalling Waveforms

Recalling Function Memory C

- 1) Set **Function C** to **ON** using button (57). The waveform you stored will appear on the screen. If Channel 1 is still on, you will see only one waveform. To see both Channel 1 and Function C, turn the **Position** knob (50) slightly.
- 2) Recall **Memory D** in the same way.

The Store Trace menu also allows the user to store any other trace, including processed or expanded waveforms, into Function C, D, E or F. The procedure outlined above enables four independent waveforms to be stored and recalled for display. Some of the parameters of the waveform can be inspected by calling the Memory Status menu, button (3) in the Main Menu.

The Panel Status and Memory Status displays

Panel Status:	Chan 1, 2, 3 and 4 only. displays the acquisition parameters for the next acquisition.
Memory Status:	All traces. displays the parameters for traces already acquired and stored.

Accessing the Memory Status Menu

- 1) In the Main Menu, press **Memory Status** button (3). The memory status for the last trace inspected in the Memory Status menu is displayed.
- 2) You can read the memory status of any trace. There are two possibilities for selecting the trace:
 - a) Use **Previous** and **Next Trace**, buttons (2) and (3).
 - b) Use the **Reference** knob (48).

WAVEFORM EXPANSION**Example 1: Expanding One Waveform (Expand A)****Acquiring a signal**

- 1) Acquire a signal on Channel 1.
- 2) Set the **Grid** mode to **Dual** (14).

Choosing an Expand function

- 3) Press **Expand A** (56).

Choosing the waveform to expand

- 4) If the source for signal expansion shown in the **Displayed Trace** field (VIII) is not **X Chan 1**, you must carry out the following procedure to redefine the expansion signal source to Channel 1.
 - a) Press the **Redefine** button (51) to display the **Redefine Source** menu in the **Menu** field (II).
 - b) Press button (6) to redefine Channel 1 as the new source for the expanded (**X-Chan 1**) display.

Choosing a magnification factor

- 5) At this point the source for **Expand A** in the **Displayed Trace** field (VIII) is updated to **X Chan 1** and all or a portion of the Channel 1 trace is intensified.

- 6) Turn the **Time Magnifier** control (54) to adjust the magnification factor (length of the intensified section) to cover the area of interest.

Note that if you turn the **Time Magnifier** knob clockwise several times the signal will be expanded so much that interpolation between data points will occur. The actual data points will be highlighted and joined by straight lines.

Choosing a region of interest

- 7) Displace the intensified section by adjusting the **Horizontal Position** control (49).

Moving the expanded waveform

- 8) You can position the expanded trace in the lower grid by adjusting the **Vertical Position** control (50).

Changing the Vertical Gain

- 9) You can also adjust the **Vert Gain** control (53) to change the vertical magnification if required.

Example 2: Expanding a Second Region of a Waveform (Expand B)

To use Expand B follow the same procedure as above, except that in Step 3 the **Expand B** button (56) is pressed rather than the **Expand A** button. You will probably need to redefine the source of **Expand B** (follow step 4 above).

For independent control of Expand A and B, make sure that **Multi Zoom** mode is OFF. Press the return button (10) until the root menu is displayed and then press button (5) to switch the **Multi Zoom** mode OFF.

Summary: Expanding a waveform

- Acquire a signal
- Choose an Expand function
- Choose the waveform to expand
- Choose a magnification factor
- Choose a region of interest
(Move the expanded waveform)
- (Change the Vertical Gain)

**Example 3: Multi Zoom
on One Waveform****Acquiring signals**

- 1) Use buttons (56) to (60) to switch Channel 1 on and all other traces off.
- 2) Acquire a signal on Channel 1.
- 3) Set the **Grid** mode to **Dual** (14).
- 4) Press the **Return** button (10) until the root menu is displayed (i.e. the only option available in the Menu field (II) is **Main Menu**).

Switching on the Expand functions

- 5) Switch **Expand A** and **Expand B** on (56). Notice two special features:
 - a) There is a highlighting frame around both expansions in the Displayed Trace field (VIII). One of the highlighting frames is made of dashed lines and the other of solid lines. The expansion function in the solid frame is the currently selected trace.
 - b) **Multi Zoom ON** appears in the Menu field (II).

Note: If this is not the case, press button (5) to switch on the multi zoom expansion feature.

Choosing the waveforms to expand

- 6) If the sources for signal expansion shown in the Displayed Trace field (VIII) are not **X Chan 1** and **X Chan 1**, redefine the expansion signal sources to Channel 1 and Channel 1 using the redefine button as follows:
 - a) Use **Select**, button (55), to place the solid highlighting frame around the expansion function which is not set as you require.
 - b) Press the **Redefine** button (51) to display the Redefine Source menu in the Menu field (II).
 - c) Press the button corresponding to the required source for the expansion.

Choosing a magnification factor

- 7) At this point the sources for **Expand A** and **Expand B** are shown in the Displayed Trace field (VII) as **X Chan 1** and **X Chan 1** and two portions of Channel 1 are intensified.

Note: If you don't see two intensified portions on the trace of Channel 1, it is because the two intensified areas are touching each other.

- 8) Turn the **Time Magnifier** knob (54) to adjust the magnification factor (length of the intensified section) to cover the area of interest.

Notice that when you turn the **Time Magnifier** knob the two expanded portions of the waveform change their magnification factors simultaneously.

Choosing a region of interest

- 9) Displace the intensified section by adjusting **Horizontal Position** control (49).

Notice that the **Horizontal Position** knob operates simultaneously on both expanded portions of the waveform.

Changing the Vertical Gain

- 10) You can also adjust the **Vert Gain** control (53) to change the vertical magnification if required.

Example 4: Expanding Two Waveforms Simultaneously Multi Zoom Expansion ON

Acquiring signals

- 1) Use buttons (56) to (60) to switch Channels 1 and 2 on and all other traces off.
- 2) Acquire a signal on Channels 1 and 2.
- 3) Set the **Grid** mode to **Dual** (14).
- 4) Press the **Return** button (10) until the root menu is displayed (i.e. the only option available in the Menu field (II) is **Main Menu**).

Switching on the Expand functions

- 5) Switch **Expand A** and **Expand B** on (56). Notice two special features:
 - a) There is a highlighting frame around both expansions in the **Displayed Trace** field (VIII). One of the highlighting frames is made of dashed lines and the other of solid lines. The expansion function in the solid frame is the currently selected trace.
 - b) **Multi Zoom ON** appears in the Menu field (II).

Note: If this is not the case, press button (5) to switch on the multi zoom expansion feature.

Choosing the waveforms to expand

- 6) If the sources for signal expansion shown in the Displayed Trace field (VIII) are not **X Chan 1** and **X Chan 2**, redefine the expansion signal sources to Channel 1 and Channel 2 using the redefine button as follows:
 - a) Use **Select** button (55) to place the solid highlighting frame around the expansion function which is not set as you require.
 - b) Press the **Redefine** button (51) to display the Redefine Source menu in the Menu field (II).
 - c) Press the button corresponding to the required source for the expansion.

Choosing a magnification factor

- 7) At this point the sources for **Expand A** and **Expand B** are shown in the Displayed Trace field (VIII) as **X Chan 1** and **X Chan 2**, and all or a portion of Channels 1 and 2 are intensified.
- 8) Turn the **Time Magnifier** knob (54) to adjust the magnification factor (length of the intensified section) to cover the area of interest.

Notice that when you turn the **Time Magnifier** knob the magnification factor changes simultaneously on both **Expand A** and **B**.

Choosing a region of interest

- 9) Displace the intensified section by adjusting **Horizontal Position** control (49).

Notice that the **Horizontal Position** knob also operates simultaneously on both **Expand A** and **B**.

Moving the expanded waveform

- 10) Position **Expand A** in the upper grid by selecting it and using the **Vertical Position** knob (50).
- 11) Position **Expand B** in the lower grid by selecting it and using the **Vertical Position** knob (50).

Changing the Vertical Gain

- 12) You can also adjust the **Vert Gain** control (53) to change the vertical magnification if required.

Example 5: Multi Zoom Expansion OFF

Acquiring signals

- 1) Use buttons (56) to (60) to switch Channels 1 and 2 on and all other traces off.
- 2) Acquire a signal on Channels 1 and 2.
- 3) Set the **Grid** mode to **Dual** (14).
- 4) Press the **Return** button (10) until the root menu is displayed (i.e. the only option available in the Menu field (II) is **Main Menu**).

Switching on the Expand functions

- 5) Switch **Expand A** and **Expand B** on (56). If multi zoom is on:
 - a) There is a highlighting frame around both expansions in the Displayed Trace field (VIII). One of the highlighting frames is made of dashed lines and the other of solid lines. The expansion function in the solid frame is the currently selected trace.
 - b) **Multi Zoom ON** appears in the Menu field (II).

Switching Multi Zoom off

- 6) Press button (5) which corresponds to **Multi Zoom ON** in the Menu field (II). **Multi Zoom OFF** is now indicated and the multi zoom feature is no longer in operation.

Notice that only one of the expansion functions is surrounded by a select frame.

Choosing the waveforms to expand

- 7) If the sources for signal expansion shown in the Displayed Trace field (VIII) are not **X Chan 1** and **X Chan 2**, redefine the expansion signal sources to Channel 1 and Channel 2 using the redefine button as follows:
 - a) Use **Select**, button (55), to place the highlighting frame around the expansion function which is not set as you require.
 - b) Press the **Redefine** button (51) to display the **Redefine Source** menu in the Menu field (II).
 - c) Press the button corresponding to the required source for the expansion.

Choosing a magnification factor

- 8) At this point the sources for **Expand A** and **Expand B** are shown in the Displayed Trace field (VIII) as **X-Chan 1 X-Chan 2** and all or a portion of Channels 1 and 2 are intensified.
- 9) Turn the **Time Magnifier** knob (54) to adjust the magnification factor (length of the intensified section) to cover the area of interest.

Now when you turn the **Time Magnifier** knob the magnification factor changes only for the selected expansion function.

Choosing a region of interest

- 10) Displace the intensified section by adjusting **Horizontal Position** control (49).

Notice that the **Horizontal Position** knob only operates on the selected expansion function.

Moving the expanded waveform

- 11) Position **Expand A** in the upper grid by selecting it and using the **Vertical Position** knob (50).
- 12) Position **Expand B** in the lower grid by selecting it and using the **Vertical Position** knob (50).

Changing the Vertical Gain

- 13) You can also adjust the **Vert Gain** control (53) to change the vertical magnification if required.

WAVEFORM PROCESSING**Arithmetic****Example 1: Addition of Channels 1 and 3****Acquire the signals for processing**

- 1) Acquire a signal on Channels 1 and 3.
- 2) Switch Channels 1 and 3 and Function E on. Switch all the other traces off, buttons (56) to (60).

Redefine the function

- 3) Press the **Redefine** button (51) to call up the menu for Function E.

Set the required function

- 4) Use the **Previous Field** and **Next Field** buttons (2) and (3) to select the **Currently Used As** field.
- 5) Use the **Previous Value** and **Next Value** buttons (4) and (5) to give this field the value **Compute**.
- 6) Use the **Previous Field** and **Next Field** buttons (2) and (3), or the **Reference** knob (48) to select the **Class** field.
- 7) Use the **Previous Value** and **Next Value** buttons (4) and (5), or the **Difference** knob (46) to set class to **Arithmetic**.
- 8) Select **Type** and set it to **Addition**.
- 9) Set **Max Number of Points** to 500.
- 10) Set **Source 1** to **Channel 1**.
- 11) Set **Source 2** to **Channel 3**.
- 12) Press the **Return** button (10) to display the grid.

Example 2: Negation of Channel 1

Acquire a signal to process

- 1) Acquire a signal on Channel 1.
- 2) Switch **Channel 1** and **Function F** on. Switch all the other traces off, buttons (56) to (60).

Redefine the function

- 3) Press the **Redefine** button (51) to call up the menu for Function F.

Set the required function

- 4) Use the **Previous Field** and **Next Field** buttons (2) and (3) to select the **Currently Used As** field.
- 5) Use the **Previous Value** and **Next Value** buttons (4) and (5) to give this field the value **Compute**.
- 6) Use the **Previous Field** and **Next Field** buttons (2) and (3) or the **Reference** knob (48) to select the **Class** field.
- 7) Use the **Previous Value** and **Next Value** buttons (4) and (5) or the **Difference** knob (46) to set class to **Arithmetic**.
- 8) Select **Type** and set it to **Negation**.
- 9) Set **Max Number of Points** to 1000.
- 10) Set **Source** to **Channel 1**.
- 11) Press the **Return** button (10) to display the grid.

**Example 3:
Summed Averaging****Acquire a signal to process**

- 1) Acquire a repetitive signal on Channel 4, using normal trigger mode.
- 2) Switch **Channel 4** and **Function F** on. Switch all the other traces off, buttons (56) to (60).

Redefine the function

- 3) Press the **Redefine** button (51) to call up the menu for Function F.

Set the required function

- 4) Use the **Previous Field** and **Next Field** buttons (2) and (3) to select the **Currently Used As** field.
- 5) Use the **Previous Value** and **Next Value** buttons (4) and (5) to give this field the value **Compute**.
- 6) Use the **Previous Field** and **Next Field** buttons (2) and (3) or the **Reference** knob (48) to select the **Class** field.
- 7) Use the **Previous Value** and **Next Value** buttons (4) and (5) or the **Difference** knob (46) to set class to **Average**.
- 8) Set **Max Number of Points** to 500.
- 9) Set **Source** to **Channel 4**.
- 10) Set **Max number of sweeps** as required.
- 11) Press the **Return** button (10) to display the grid.

Summary: Waveform Processing

Sources:	Channels 1, 2, 3, 4
Functions:	Summed averaging
	Arithmetic- Identity
	Negation
	Addition
	Subtraction

Procedure

Acquire the signal(s)
Select and redefine Function E or F
Set the required function

The purpose of this section is to offer some functional hints that will ensure the best possible operation of the instrument.

RAPID RESPONSE OF THE FRONT-PANEL CONTROLS

All the front-panel controls are constantly monitored by the 9424's internal processor. Any action performed on the front panel is detected by the processor and the requested changes are implemented very rapidly.

During data acquisition (measurement of input signals), the internal processor is also busy with data-taking controls, calculations and display generation. Under certain conditions, (e.g. RIS mode or slow time base), the response time of the front-panel controls increases. For example, when the user tries to move a trace up or down on the screen, it tends to move with a jumping motion.

Whenever slow response to the control knobs is noticed, set the trigger mode to **Single**. Acquisition is stopped, the display of the waveform is frozen and the response time of control knobs returns to normal. Once the waveform manipulations have been done, return to **Normal** or **Auto** trigger.

ACCURATE AMPLITUDE MEASUREMENTS

The 9424's digitizers are 8-bit, analog-to-digital converters that measure the amplitude of input signals by subdividing them into 256 levels.

You can ensure maximum measurement resolution by using the full dynamic range of the converters, i.e. using input signals close to full scale. Half-scale signals are in 128 levels only, reducing measurement resolution by a factor of two.

To facilitate the adjustment of a full-scale ADC signal, the oscilloscope's display has been designed to represent the minimum level of the ADC as the bottom line of the grid. The maximum level is represented by the top line of the grid.

To make the best use of the ADC's dynamic range, and thereby achieve highest resolution amplitude measurements, the signal should completely fill the display grid as shown in Figure 74. The fully calibrated and continuously adjustable input-signal conditioning allows you to meet this requirement easily and without loss of calibration.

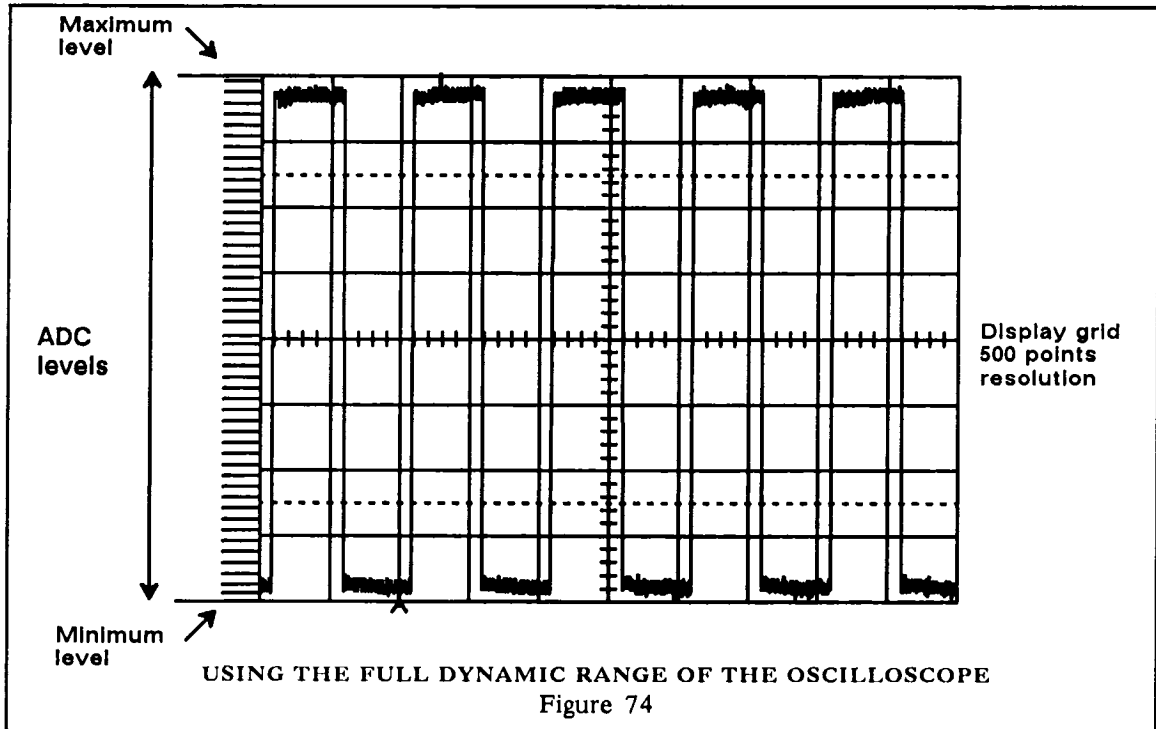

Since an overlapping display of two or more full-scale waveforms could become confusing, a multi-grid format is provided for use in applications where two or more channels are used simultaneously.

ACCURATE TIME MEASUREMENTS

Deep acquisition memories, each storing up to 50,000 points, provide the very high time resolution of the 9424.

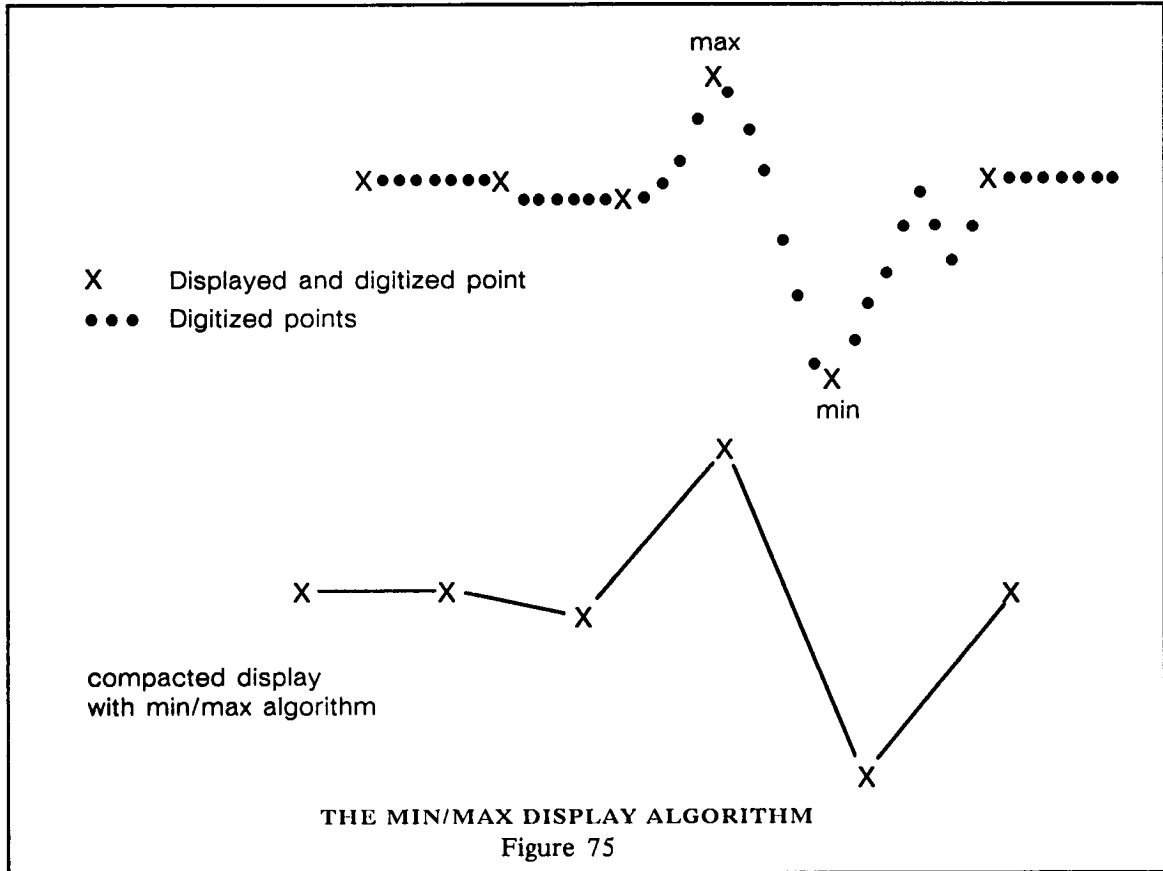



These points are displayed on the screen with a resolution of 500 display points. A compacting algorithm showing all minimum and maximum values ensures that no information is lost when a trace is displayed (see Figure 75). Time cursors can be positioned accurately on any one of the 500 display points of a compacted trace. The corresponding measurement accuracy is $1/500$ or 0.2% of the time-base setting with resolution of $1/2000$ (0.05%) of full horizontal scale.

To improve measurement accuracy, four expansion functions, **Expand A and B** and **Functions C and D**, are provided to display every digitized point on the trace. Expansion up to 1000 times is

possible. When the expansion factor is such that 500 measured points are to be displayed, every display point corresponds to a digitized point.

When the time base requires that less than 500 digitized points fill the screen, the oscilloscope interpolates using straight line segments between the actual points. If 200 or fewer points are used, the digitized points are clearly visible as intensified points on the display. When a cursor is placed on an actual measured point, a small horizontal bar appears on the cursor as follows:

Time cursor: 
Cross-hair marker: 

In Figure 76, **Expand A** and **B** are used to expand the compacted trace of a 50000-point waveform by a factor of 1000 to provide maximum time measurement resolution. Under these conditions, the expanded trace displays 50 digitized points. The time cursor measurement resolution is 1/50000 (0.002%) of the full horizontal scale. Between digitized points (intensified dots) linearly interpolated readings are shown.

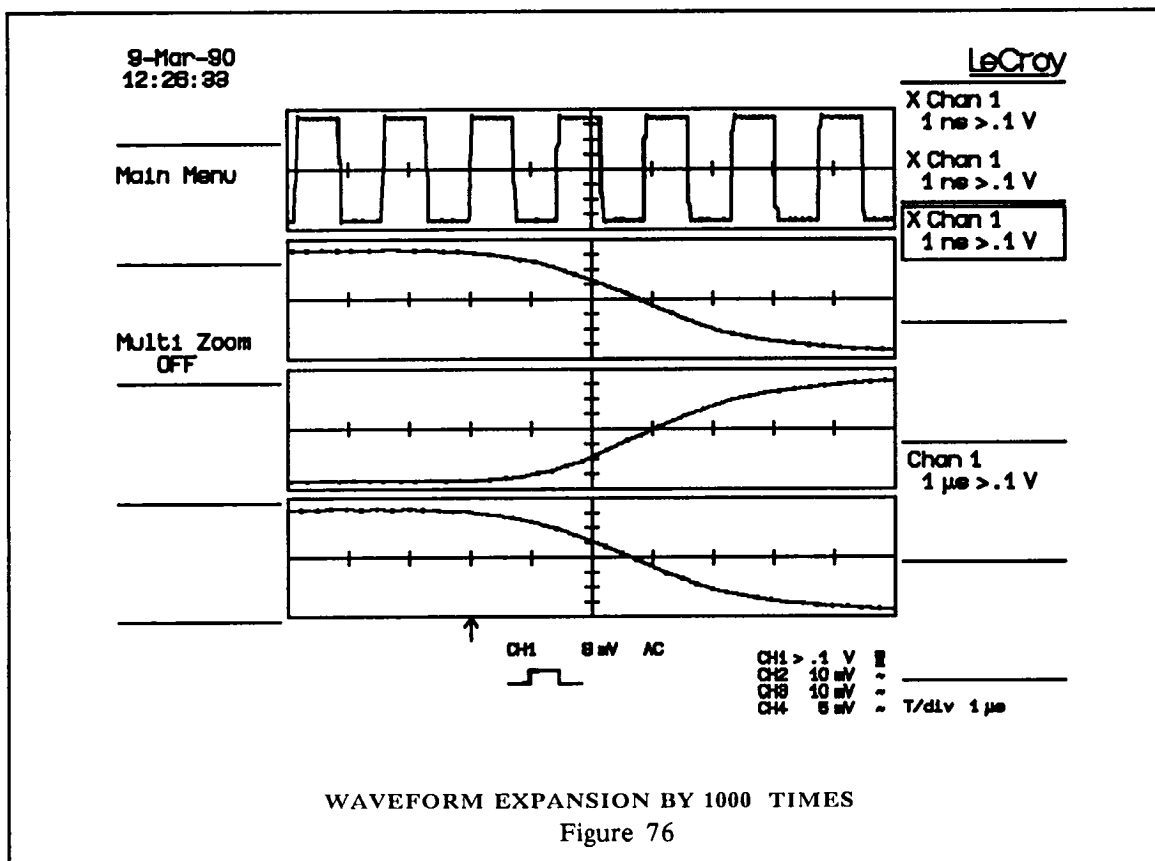

AUTO-CALIBRATION

The 9424 calibrates its time interpolator relative to the internal 100 MHz crystal-controlled clock generator every time the time base is modified by front-panel operation or by remote control.

The vertical gain and offset of an input channel are calibrated by means of a very stable internal 12-bit digital-to-analog converter every time the fixed gain control of this channel is modified. Calibration of channels also takes place whenever the bandwidth limit is changed.

These calibrations are necessary largely because of drifts caused by temperature changes which could arise if the instrument is left in the same state for a very long time. To avoid measurement errors due to potential drifts, the oscilloscope regularly performs an auto-calibration. This operation is transparent to the user, but is audible due to relay switching. Auto-calibration is done once a

11 *Getting More from your Oscilloscope*

minute for the first 25 minutes after the oscilloscope is turned on, and once every 20 minutes thereafter. Note that auto-calibration does not occur when the oscilloscope is waiting for a trigger or actually acquiring data. It only occurs before a new acquisition is started.

In remote control, it is possible to issue a command to turn off auto-calibration. Such a command can be sent at any time.

The WP01 Waveform Processing Option adds enhanced processing capabilities to the standard oscilloscope functions described in Section 5. The package provides five classes of operations:

- Average:** Summed and Continuous.
- Arithmetic:** Identity, Negation, Reciprocal, Addition, Subtraction, Multiplication and Ratio.
- Extrema:** Roof for maxima, Floor for minima, Roof and Floor for maxima and minima.
- Functions:** Integral, Derivative, Square, Square Root, Logarithm e, Exponential e, Logarithm 10, Exponential 10 and Absolute.
- Enhanced Resolution:** A digital filtering technique to improve signal-to-noise ratio and improve vertical resolution.

This section describes the WP01 option. The remote commands for the control of WP01 processing as well as waveform transfer to and from a host computer are listed in the Remote Control Manual.

PROCESSING CAPABILITIES

Processing can be performed on any source waveform (Channel 1, 2, 3 and 4, Expand A and B, Functions C, D, E and F) and may be activated by pressing Function buttons C, D, E or F (57) and (58). Waveform processing is automatic as long as a function trace (or an expansion of a function) is switched ON. Using Functions C, D, E and F enables simultaneous computation of up to four different processing routines.

The display control knobs ((50) and (53)) may be used to adjust the vertical position and vertical gain of a selected function. Functions may also be expanded horizontally by allowing them to be the source waveform of the Expand traces.

Processed waveforms can be read by remote control, stored in reference memories, expanded or processed in the other functions. Chaining of operations is also possible.

Waveform processing can take an appreciable execution time when operating on many data points. The user can reduce the execution time by limiting the **Max number of points** which are used in the computation. However, users should be aware that reducing the number of processed points effectively reduces the sampling rate of the input record and the corresponding Nyquist frequency and may lead to aliasing.

The oscilloscope executes the waveform processing function on the entire waveform (as displayed on the screen) by taking every

Nth point, N depending on the time base and the **Max number of points** selected. The first point of such a reduced record is the first valid point of the input record, usually the point on the left-hand edge of the screen.

The user can modify a processing definition either from a front-panel menu, which may be called by pressing the **Redefine** button (51), or through remote commands.

If the user has set up a circular definition (e.g. $FE = \text{func}(FF)$ and $FF = \text{func}(FE)$), a warning message is displayed and no processing is applied to the waveforms.

Setting Up a Waveform Processing Function

It is generally good practice to stop data acquisition while preparing new conditions for waveform processing (by setting the trigger mode (31) to **Single**) because the response time might be slow for some function setups. To access the function menus, use the **Select** button (55) to make sure that the function is selected (i.e. is surrounded by a solid box in the Displayed Trace field (VIII)), and then press **Redefine** (51). A full page setup menu will appear on the screen. To return to the normal waveform display, press either the **Return** button (10) or the **Redefine** button.

In the function menu, the function and its parameters may be modified with buttons (2) to (5). First select the field to be modified. The rectangular frame around parameter values indicates the currently selected field. Pressing the **Previous Field** button (2) will cause the frame to move towards the top of the list, whereas pressing the **Next Field** button (3) will cause the frame to move downwards. As an alternative, the **Reference** knob (48) may be used to move rapidly through the fields.

After field selection, the current value of the field may be modified by pressing either the **Previous** or **Next Value** button ((4) or (5)) or using the **Difference** knob (46). Since the identity of the lower fields may depend on the function chosen, modify the parameters from top to bottom.

SUMMED AVERAGE

Summed averaging consists of the repeated addition, with equal weight, of successive source waveform records. If a stable trigger is available, the resulting average has a reduced random noise component, compared with a single-shot record. Whenever the maximum number of sweeps is reached, the averaging process stops. The process may be interrupted by switching the trigger mode from **Norm** trace to **Single** (31) or by turning the function trace **OFF** ((57 or (58)). Averaging will continue when these actions are reversed.

The accumulated average may be reset by changing an acquisition parameter, such as input gain, offset or coupling, trigger condition, time base or bandwidth limit. The number of currently averaged waveforms (of the function or of its expansion) is displayed in the Displayed Trace field (VIII).

Whenever the maximum number of sweeps is reached, a larger number of sweeps may be accumulated by simply changing the maximum number of sweeps in the setup menu. In this case care must be taken to leave the other parameters unchanged, otherwise a new averaging calculation is started.

A waveform to be added to the average may contain overflow or underflow values (corresponding to the saturation levels of the ADC). By using artifact rejection, the user may choose whether to reject or accept these waveforms.

If **Artifact rejection** is OFF, the waveform is added to the average. Of course, the average will be incorrect at the positions where overflow or underflow occurred.

If **Artifact rejection** is ON, waveforms containing any overflows or underflows are not added to the average. If waveforms consistently contain overflows or underflows, averaging cannot proceed and the number of accumulated sweeps may remain constant indefinitely.

In order to further improve the signal-to-noise ratio, the instrument offers the possibility of performing offset dithering. When **Dithering** is turned ON, a small hardware offset, of between +6 and -6 LSB of the 8-bit ADC (about 1/5 vertical division) is added to the input signal before acquiring a waveform. The offset is changed for successive waveforms, and the average of the offsets tends to zero. Because dithering makes each successive waveform use a slightly different portion of the ADC, the differential non-linearities of the ADC also tend to be averaged out. Care must be taken that the amplitude of the waveform does not fall within 1/5 of a vertical division from the top and the bottom of the display grid since overflows or underflows might occur. When dithering, the channel waveforms are compensated for the dither offset so that the waveform values, as read out by remote control or by cursor measurements, remain unaffected.

Offset dithering is mainly of interest when the waveform to be averaged is already relatively "clean", i.e. contains noise variations of less than 1/5 division. In such a case, differential non-linearities can be reduced by up to a factor of 4. In contrast, waveforms which have high levels of noise (>1/5 of a vertical division) do their own "dithering", making artificial offset variations superfluous.

When summed averaging is turned on, the display is updated at a reduced rate (about once every 1.5 sec), to increase the averaging speed (points per second and events per second).

Before processing, the source waveform may be decimated by a factor depending on the selected **Max number of points** and the source record number of points. The resulting number of points is displayed at the bottom of the function menu. An example of the function menu for summed averaging is shown in Figure 77.

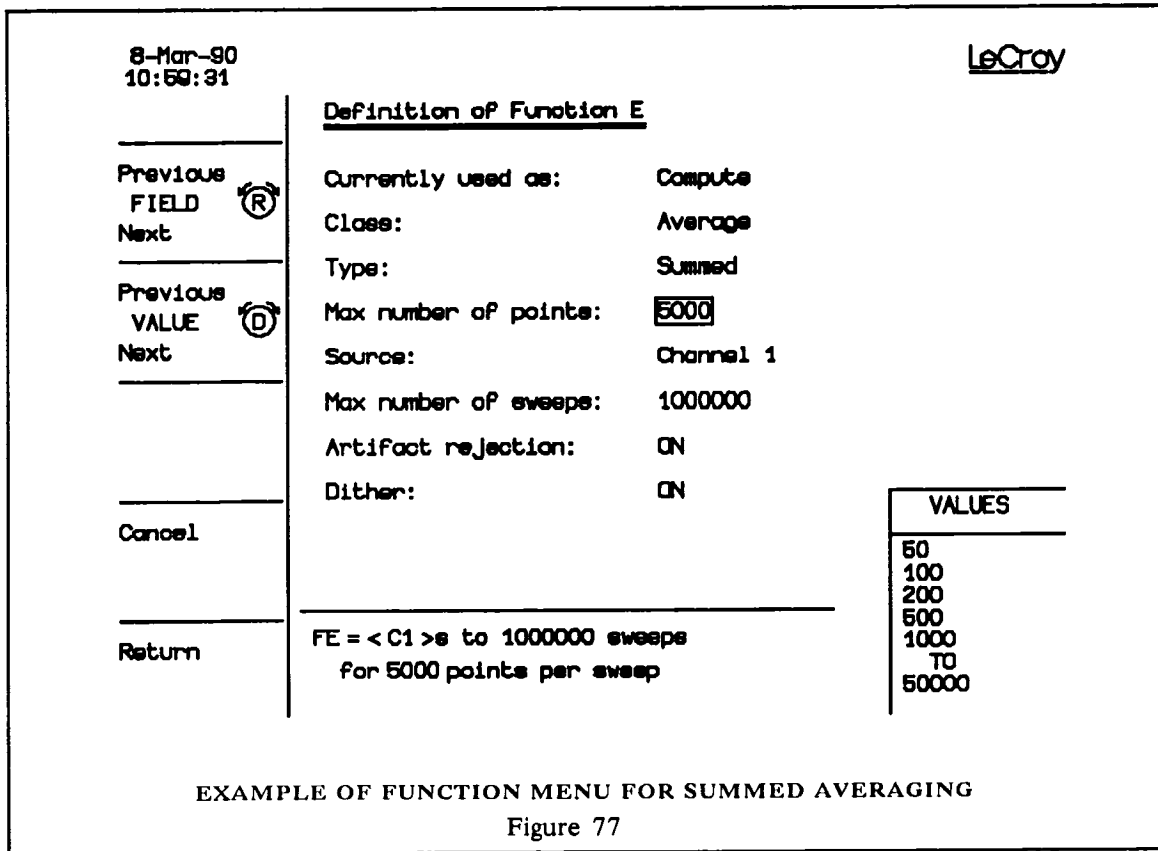

Summed Averaging of Sequence Waveforms

Summed averaging can be applied to sequence waveforms to give the average of the segments. It can also be applied to an expansion showing a segment of a sequence, to give the average waveform for that segment over many sequence acquisitions.

When summed averaging is applied to a sequence waveform, all segments of one sequence are added up.

Averaging is restarted for each newly acquired sequence.

CONTINUOUS AVERAGE

Continuous averaging (also called exponential averaging) consists of the repeated addition, with unequal weight, of successive source waveforms. The technique is particularly useful for reducing noise on signals which drift very slowly in time or amplitude. Each new record is added to the accumulated average according to the formula :

$$S(i, new) = \frac{N}{N + 1} [S(i, old)] + \frac{1}{N + 1} [W(i)]$$

where

i index over all data points of the waveforms

$W(i)$ newly acquired waveform

$S(i, old)$ old accumulated average

$S(i, new)$ new accumulated average

N Weight, may be 1, 3, 7, 15, 31, 63, 127

The factors $N/(N+1)$ and $1/(N+1)$ determine the weighting at which the continuous average is applied to the source waveform. Note that the sum of the two factors adds up to the value of 1, so that the continuous average of noisy, but otherwise repetitive waveforms, resembles the summed average of such waveforms. However, the statistics of a continuous average tend to be worse than those from a summed average on the same number of sweeps, since the most recently acquired waveform has more weight than all previously acquired ones. Therefore, the continuous average is dominated by the statistical fluctuations of the most recently acquired waveforms.

The weight of "old" waveforms in the continuous average gradually tends to zero, at a rate which decreases with the increase of N .

The averaging process may be interrupted by switching the trigger mode from **Norm** to **Single** (31) or by turning the function trace OFF ((57) and (58)). Averaging will continue when these actions are reversed. The currently accumulated average may be reset by changing an acquisition parameter, such as input gain, offset or coupling, trigger condition, time base or bandwidth limit.

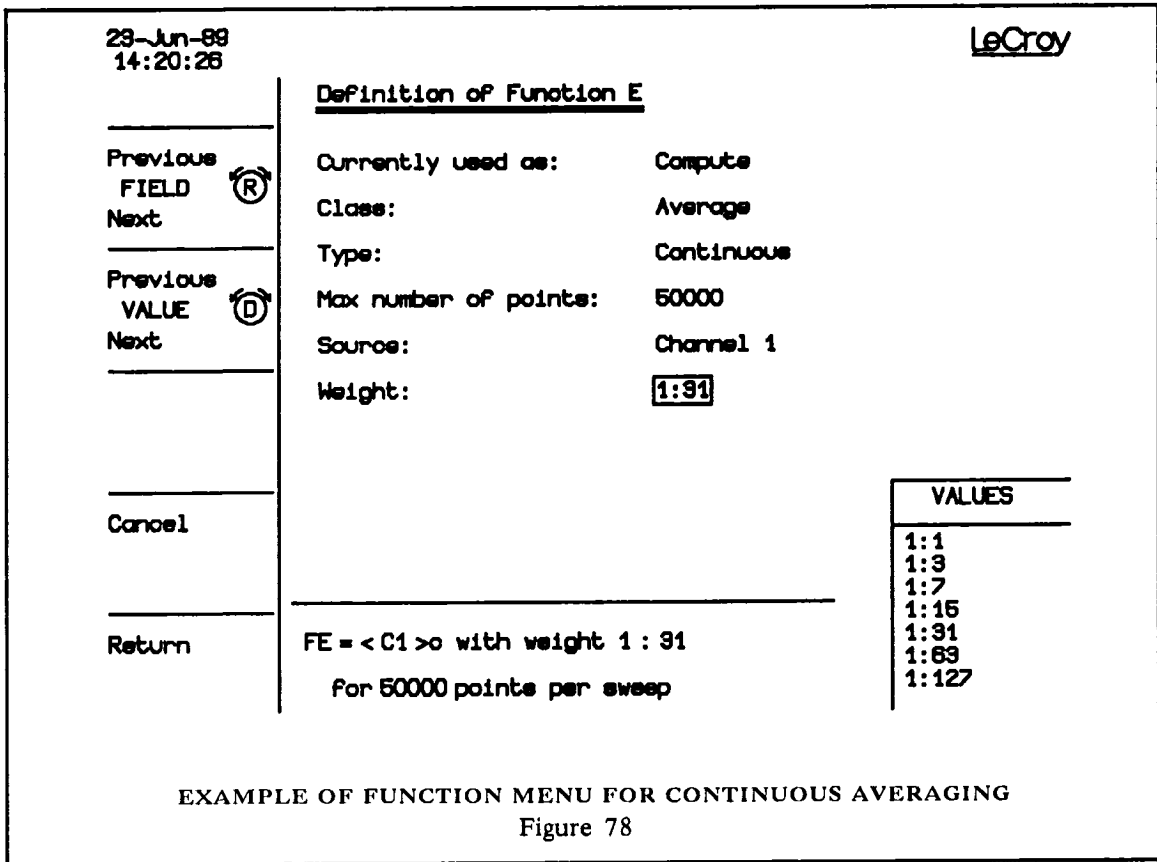

Before processing, the source waveform may be decimated by a factor depending on the selected **Max number of points** and the source record number of points. The resulting number of points is displayed at the bottom of the function menu. See Figure 78 for an example of the function menu with continuous averaging.

ARITHMETIC

Identity, Negation and Reciprocal can be computed from any source waveform and **Addition, Subtraction, Multiplication and Ratio** can be computed for any pair of compatible waveforms.

The arithmetic operations are applied to one or two source waveforms on a data point per data point basis. Different vertical gains and offsets of the two sources are automatically taken into account in the computed result. However, both source waveforms must have the same time base. The trigger point may be different in

the two source waveforms, although in this case the results may be difficult to interpret.

Before processing, the source waveform may be decimated by a factor depending on the selected **Max number of points** and the source record number of points. The resulting number of points is displayed at the bottom of the function menu.

23-Jun-89 14:47:17		LeCroy	
<u>Definition of Function E</u>			
Previous FIELD (R)	Currently used as:	Compute	
Next	Class:	Arithmetic	
Previous VALUE (D)	Type:	<u>Subtraction</u>	
Next	Max number of points:	50000	
	Source 1:	Channel 1	
	Multiplication factor:	1.000 μ^0	
	Additive constant:	+0.000 μ^0 V	
	Source 2:	Channel 2	
Cancel			
Return	FE = C1 - C2 for 50000 points		
			VALUES Identity Negation Reciprocal Addition Subtraction Multiplioat Ratio

EXAMPLE OF FUNCTION MENU SET UP FOR SUBTRACTION OF CHANNEL 2 FROM CHANNEL 1
Figure 79

Before processing, the **Source 1** waveform may be multiplied by a constant **Multiplication factor** in the range 0.001×10^{-33} to 999.999×10^{33} and be offset by an **Additive constant** in the range -999.999×10^{33} to 999.999×10^{33} times the vertical unit of the **Source 1** waveform. An example of the function menu set up for the subtraction of Channel 2 from Channel 1 is shown in Figure 79.

EXTREMA

Extrema waveforms are computed by a repeated comparison of successive source waveform records with the already accumulated extrema waveform, which consists of a maxima record (roof) and a minima record (floor). Whenever a given data point of the new waveform exceeds the corresponding maximum value in the roof record, it replaces it. If the new data point is smaller than the corresponding floor value, it replaces it. Thus the maximum and the minimum envelope of all waveform records is accumulated.

Roof and Floor records can be displayed individually or both together.

23-Jun-89
15:00:00

Previous FIELD R
Next

Previous VALUE D
Next

Cancel

Return

LeCroy

Definition of Function E

Currently used as: Compute

Class: Extrema

Type: Roof + Floor

Max number of points: 20000

Source: Channel 1

Max number of sweeps: 7600

FE = rf+F1 (C1) for 7600 sweeps
for 10000 points per sweep

VALUES

1

TO

1000000

EXAMPLE OF FUNCTION MENU SET UP FOR ROOF AND FLOOR EXTREMA

Figure 80

Whenever the selected maximum number of sweeps is reached, the accumulation process stops. The process may be interrupted by switching the trigger mode from **Norm** to **Single** (31) or by turning the function trace **OFF** ((57) and (58)). Accumulation will continue when these actions are reversed. The currently accumulated extrema waveform may be reset by either changing an acquisition parameter, such as input gain, offset or coupling, trigger condition or the time base or bandwidth limit. The number of currently accumulated waveforms is displayed in the **Displayed Trace** field (VIII) of the function or of its expansion.

A larger number of sweeps may be accumulated by simply changing the maximum number of sweeps in the setup menu. In this case, care must be taken to leave the other parameters unchanged, otherwise the extrema calculation is started again.

The number of points in the output waveform may be decimated by a factor depending on the selected **Max number of points** and the source record number of points. All of the input data will be used to determine the envelope irrespective of the decimation selected. The resulting number of points is displayed at the bottom of the function menu. An example of the function menu set up for roof and floor extrema is shown in Figure 80 .

FUNCTIONS

The following mathematical functions can be applied to any waveform: **Integral**, **Derivative**, **Square**, **Square Root**, **Logarithm e**, **Exponential e**, **Logarithm 10**, **Exponential 10** and **Absolute Value**.

Square Root is actually computed on the absolute value of the source waveform.

For logarithmic and exponential functions, the numerical value (without units) of the input waveform is used.

Before processing, the **Source** waveform may be decimated by a factor depending on the selected **Max number of points** and the source record number of points. The resulting number of points is displayed at the bottom of the function menu.

Before processing, the source waveform may be multiplied by a constant **Multiplication factor** in the range 0.001×10^{-33} to 999.999×10^{33} and be offset by an **Additive constant** in the range -999.999×10^{33} to 999.999×10^{33} times the vertical unit of the source waveform.

ENHANCED RESOLUTION Quite often the high sampling rate available in LeCroy oscilloscopes is higher than is actually required for the bandwidth of the signal being analyzed. This oversampling, facilitated by the oscilloscope's long memories, can be used to advantage by filtering the digitized signal in order to increase the effective resolution of the displayed trace. This is similar to smoothing the signal with a simple moving average filter, except that it is more efficient in terms of bandwidth, and has better passband characteristics. It can be used instead of averaging successive traces for waveforms with single-shot characteristics.

Advantages of Enhanced Resolution

Two subtly different characteristics of the instrument are improved by the enhanced resolution filtering:

1. In all cases the resolution (i.e. the ability to distinguish closely-spaced voltage levels) is improved by a fixed amount for each filter. This is a true increase in resolution which occurs whether or not the signal is noisy, and whether or not it is a single-shot or a repetitive signal.
2. The signal-to-noise ratio (SNR) is improved in a manner which depends on the form of the noise in the original signal. This occurs because the enhanced resolution filtering decreases the bandwidth of the signal, and will therefore filter out some of the noise.

Implementation

The oscilloscope implements a set of linear phase finite impulse response (FIR) filters, optimised to provide fast computation, excellent step response and minimum bandwidth reduction for resolution improvements of between 0.5 and 3 bits in 0.5 bit steps. Each 0.5 bit step corresponds to a bandwidth reduction by a factor of two, allowing easy control of the bandwidth/resolution trade-off. The parameters of the six filters are given in the following table:

Resolution Increase (Enhancement)	-3 dB Bandwidth (x Nyquist)	Filter Length (samples)
0.5	0.5	2
1	0.241	5
1.5	0.121	10
2	0.058	24
2.5	0.029	51
3	0.016	117

**Parameters of the FIR
Enhanced Resolution Filters**

The filters used are low-pass filters, so the actual increase in SNR obtained in any particular situation will depend on the power spectral density of the noise present on the signal. The improvement in SNR corresponds to the improvement in resolution if the noise in the signal is white, i.e. evenly distributed across the frequency spectrum. If the noise power is biased towards high frequencies then the SNR improvement will be better than the resolution improvement. Whereas if the noise is mostly at lower frequencies, the improvement may not be as good as the resolution improvement. The improvement in the SNR due to the removal of coherent noise signals (for example, feed-through of clock signals) depends on whether the dominant frequency components of the signal fall in the passband of the filter or not. This can easily be deduced by using the spectrum analysis option (WP02) of the oscilloscope.

As an aid to choosing the appropriate filter for a given application, the Enhanced Resolution menu (see Figure 81) indicates the -3 dB bandwidth of the current filter in two ways. Firstly as a percentage of the Nyquist frequency, and secondly the actual frequency that this corresponds to for the time-base setting of the current waveform.

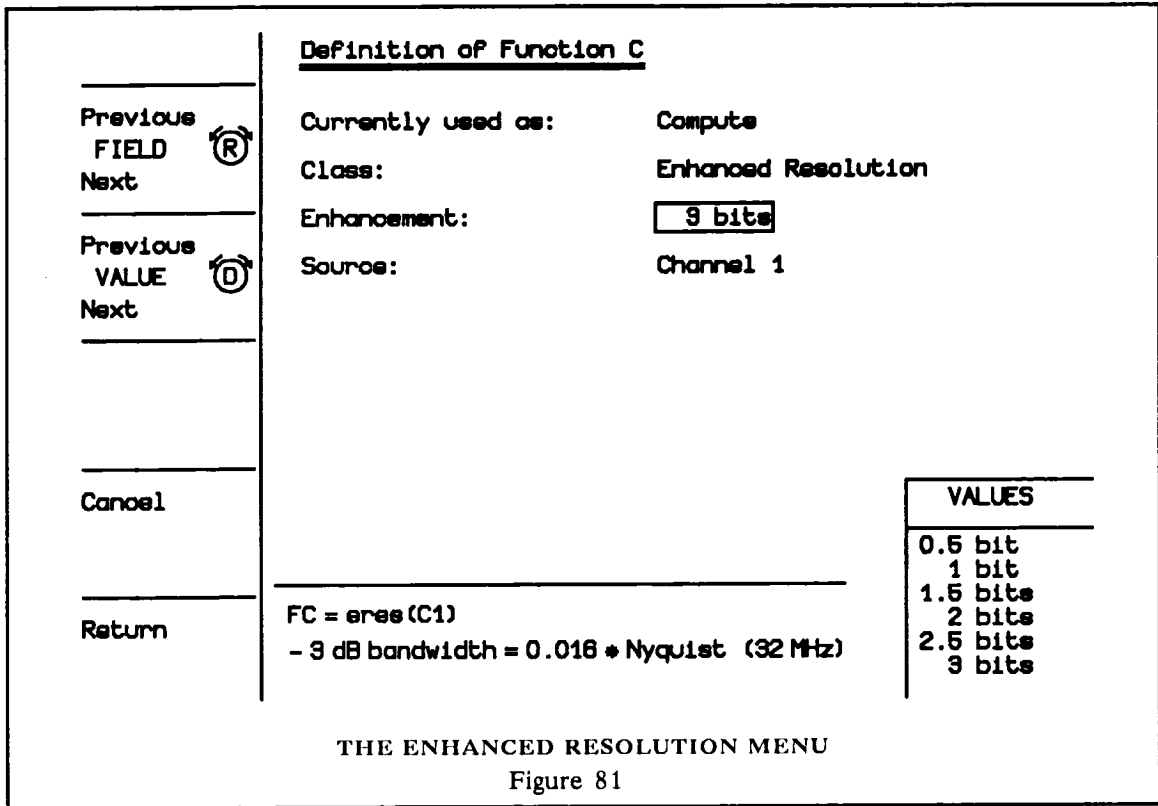

The filters used for the enhanced resolution function have an exactly linear phase response. This has two desirable properties. Firstly, the filters do not distort the relative position of different events in the waveform even if the frequency content of the events is different. Secondly, by also using the fact that the waveforms are stored, the delay normally associated with filtering (between the input and output waveforms) can be exactly compensated for during the computation of the filtered waveform.

All filters have been implemented to have exactly unity gain (at low frequency). Therefore, enhanced resolution should not cause overflow if the source data were not overflowed. If part of the source trace had overflowed, filtering will be allowed, but it must be remembered that the results in the vicinity (within the length of the filter impulse response) of the overflowed data will be incorrect. This is permitted because in some circumstances an overflow may be a spike of only one or two samples. The energy in this spike

might not be sufficient to significantly affect the results, so it would be undesirable to disallow the whole trace in this case.

When should Enhanced Resolution be used?

There are two main situations for which enhanced resolution is especially useful. Firstly, if the signal is noticeably noisy (and measurements of the noise are not required), the signal can be "cleaned up" by using the enhanced resolution function. Secondly, even if the signal is not particularly noisy, but high precision measurements of the waveform are required (perhaps when using Expand with high vertical gain) then enhanced resolution will increase the resolution of the measurements.

In general, enhanced resolution replaces the averaging function in situations where the data record has a single-shot or slowly repetitive nature and averaging cannot be used.

The following examples illustrate uses of the enhanced resolution function in these situations.

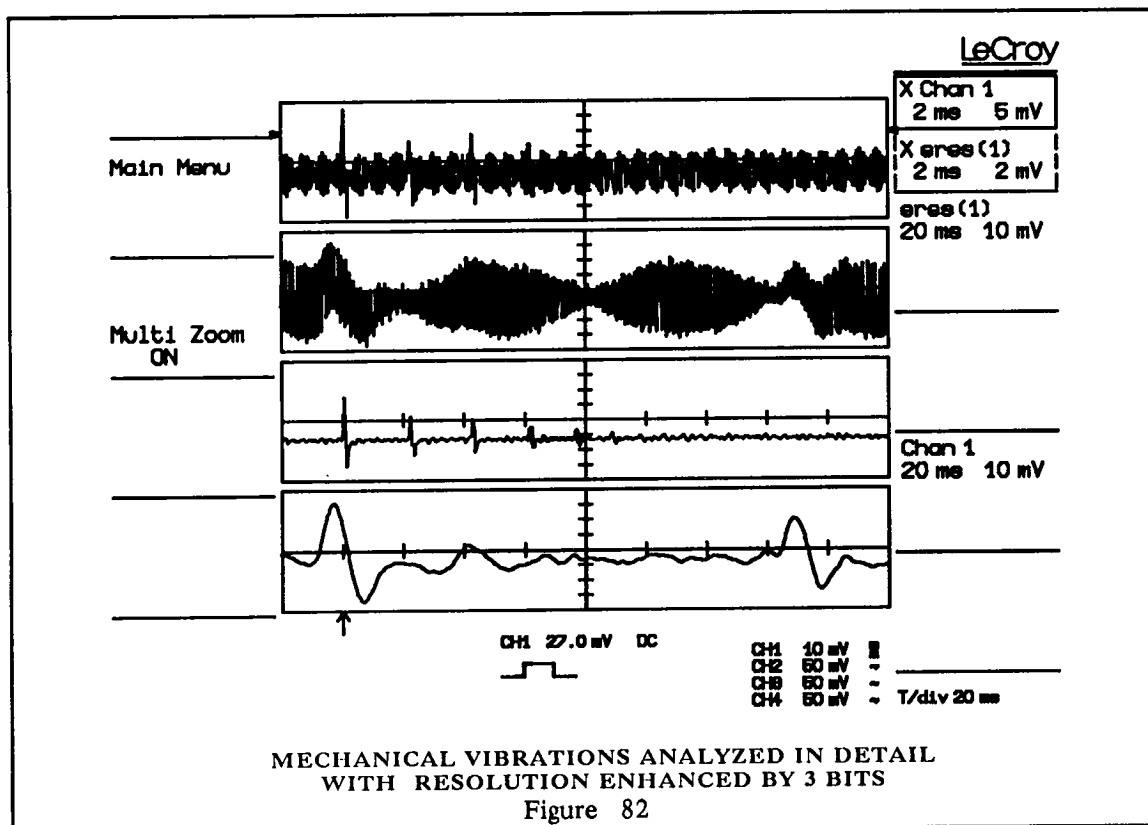
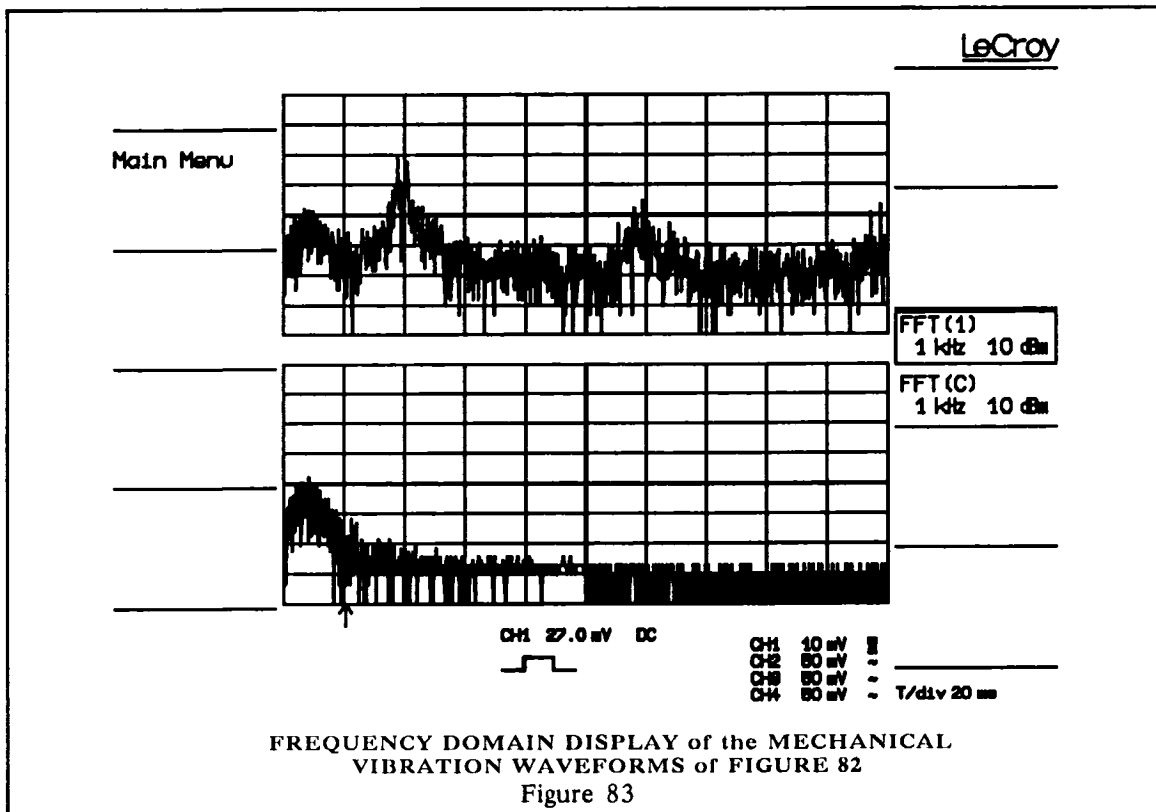

Figure 82 shows the effect of enhanced resolution on a single-shot mechanical vibration, where the trace is scaled according to the event which caused the trigger, but the small vibrations in the tail of the response are also of interest. The top grid shows the original signal, the grid below being the expansion ($\times 10$ horizontally) of the original trace. The expansion is of approximately the 5th time division from the left. The bottom two grids show the same signals after 3-bit resolution enhancement.



For the above case the filtering effect of the enhanced resolution function is also shown in the frequency domain by the FFT function (available as an option). Figure 83 shows the power spectrum of the signals in Figure 82. The upper trace is the spectrum of Channel 1, and the lower trace is the spectrum of Function C, i.e. Channel 1 after enhanced resolution filtering. The 3.0-bit enhancement filter has a -3 dB bandwidth of 0.016 times the Nyquist frequency, which is about 0.16 horizontal divisions in this case.

The filter removes energy from the signal above this frequency. The residual spikes in the lower trace at the -80 dB level are due to the processing noise (finite arithmetic effects) of long FFT computations.

Figure 84 shows a step response with some ringing (upper trace). The lower trace is the expansion ($\times 2.5$ vertically, $\times 100$ horizontally) of this step response in the region of the initial peak. The middle trace, which is the expansion of the same step response after 1-bit enhanced resolution filtering, clearly shows the advantage of even a modest resolution enhancement of 1 bit.

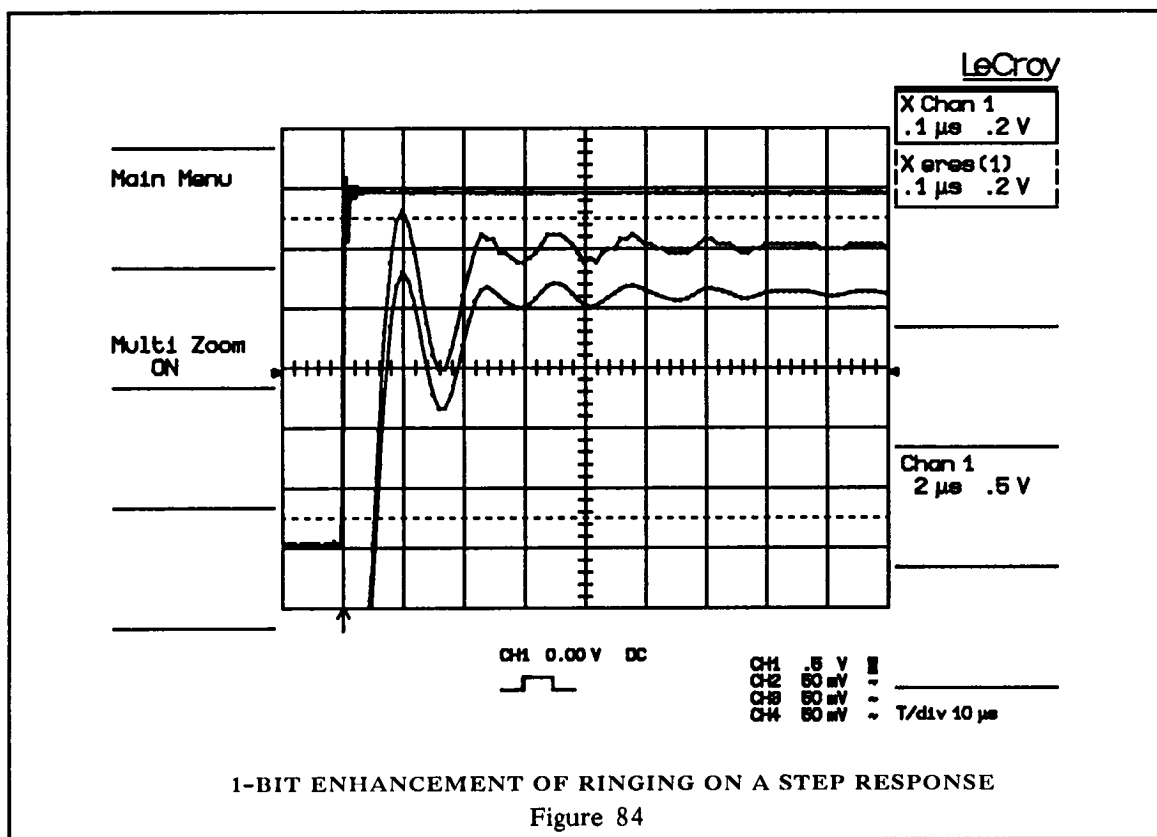

Enhanced Resolution on RIS waveforms

Enhanced resolution can almost always be used on RIS waveforms without any loss of bandwidth because the RIS traces are usually highly oversampled with respect to the analog bandwidth of the oscilloscope. For example, at least 1-bit enhancement can always be used for RIS waveforms with a time base of 1 $\mu\text{sec}/\text{div}$ or faster. This is illustrated in Figure 85 where a 50 MHz signal is displayed with (top trace) and without (second trace) 1-bit resolution enhancement. The improvement can easily be seen on the 5 times vertically expanded traces shown below. In this case the -3 dB bandwidth of the digital enhanced resolution filter was 1.2 GHz, and thus it has no significant effect on the signal bandwidth of the instrument.

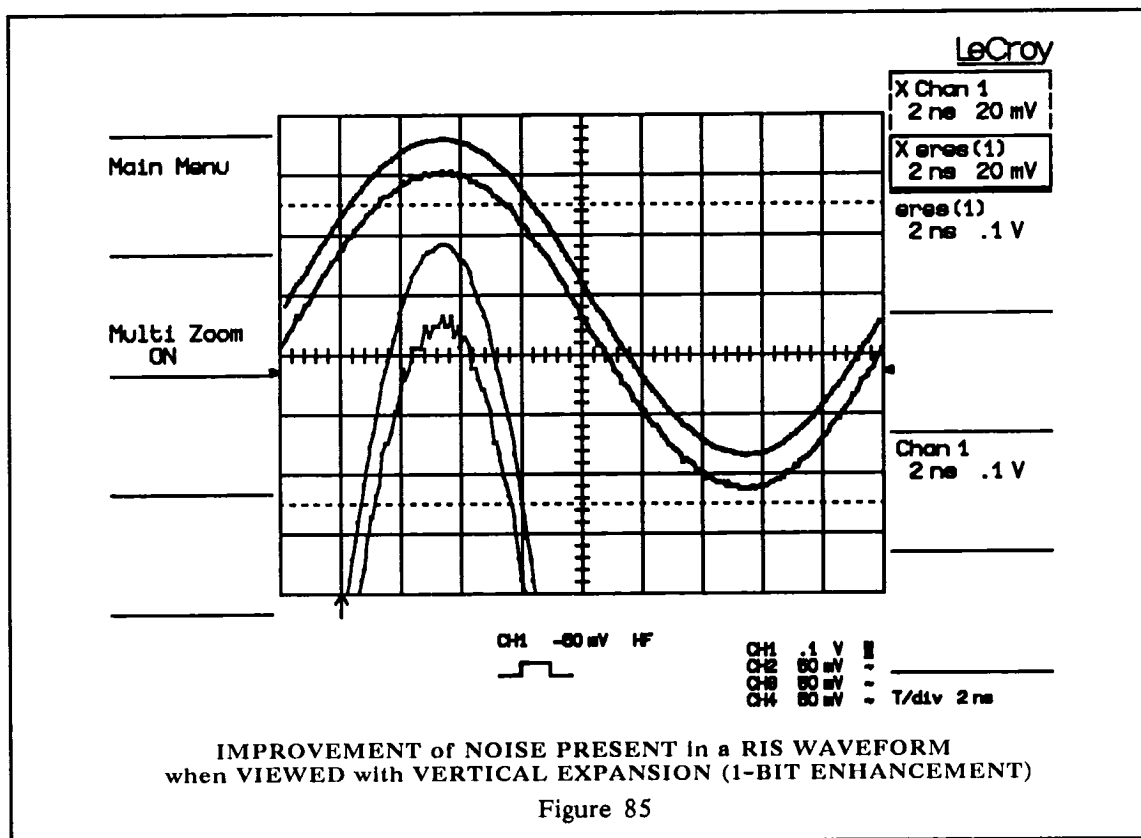

Conversely, RIS is very useful for increasing the sampling frequency of repetitive signals prior to enhanced resolution filtering even if RIS wouldn't be used for the normal trace. This is because the

- 3 dB bandwidth of the filter is increased by the increase in effective sampling frequency and a more severe filter (greater enhancement) can be used for a similar loss of bandwidth. This is illustrated in Figure 86, which is the same as Figure 84 except that RIS was switched on, allowing the enhancement to be increased to 3 bits.

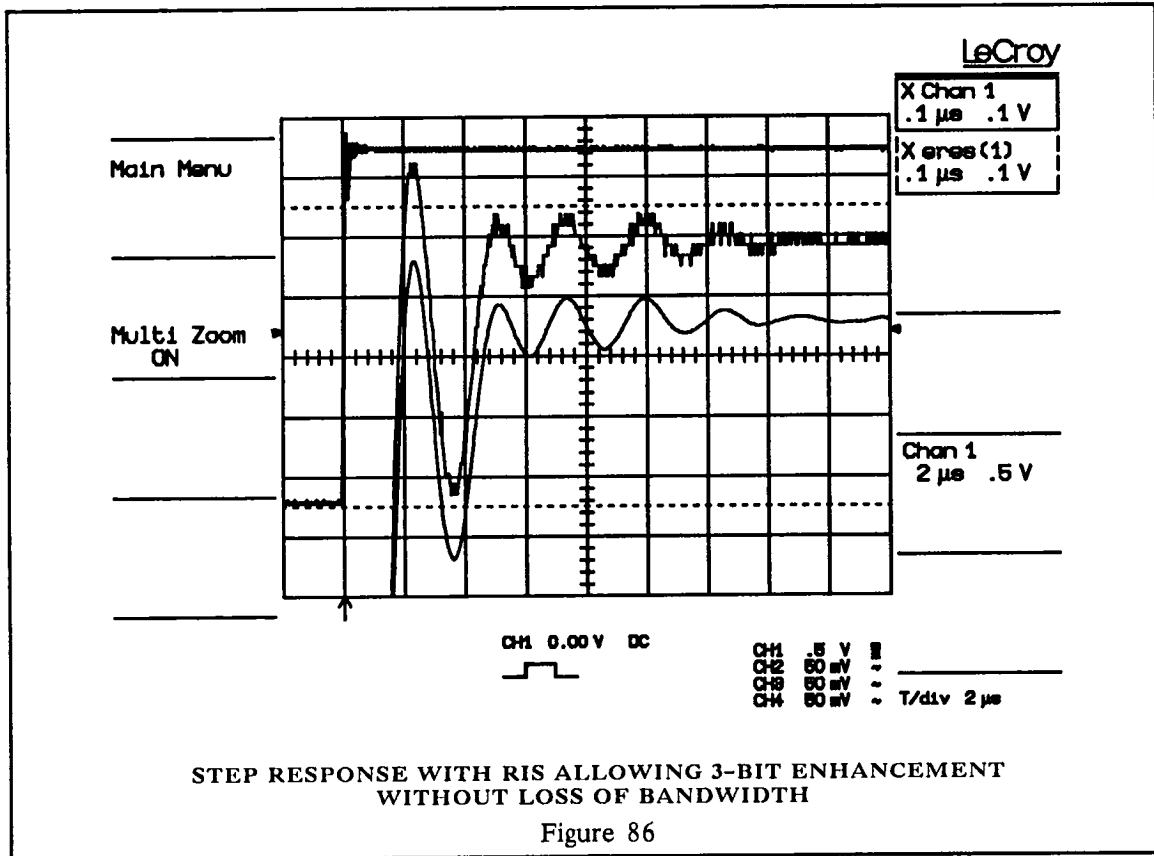

Signal filtering with the Enhanced Resolution Function

Since the filters used for increasing the resolution are low-pass filters, they can also be used as low-pass signal filters in some situations. With careful choice of the filter bandwidth as a percentage of Nyquist frequency (via choice of the filter's resolution increase) and of the Nyquist frequency (via choice of the time base), the filters can be used to remove or reduce the effects of high frequency interfering signals. The spectrum analysis function will be an invaluable aid to determining the relationship between the different component frequencies of the signal. Using, for example, FFT

Power Spectrum, this information can conveniently be seen directly in terms of the current Nyquist frequency, so the correct choice of filter becomes simple. The spectrum analysis can also be used after filtering to confirm the presence, or otherwise, of the various components of the original signal.

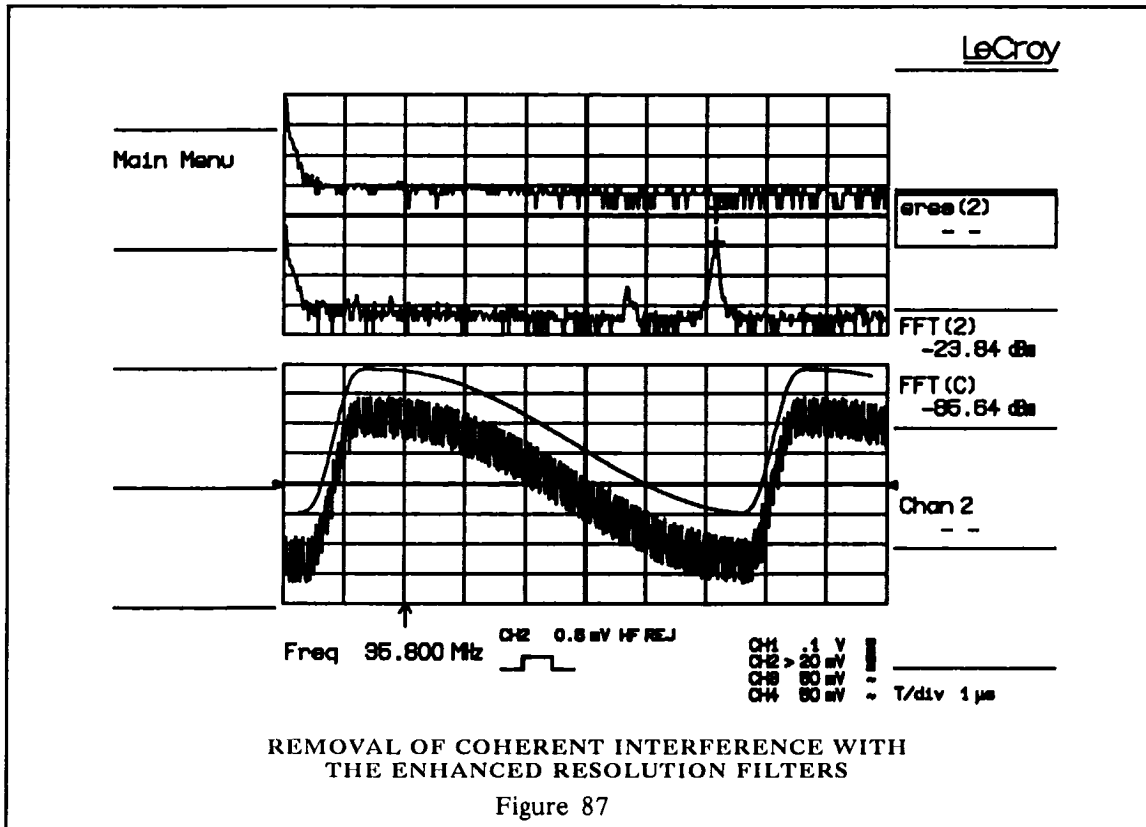
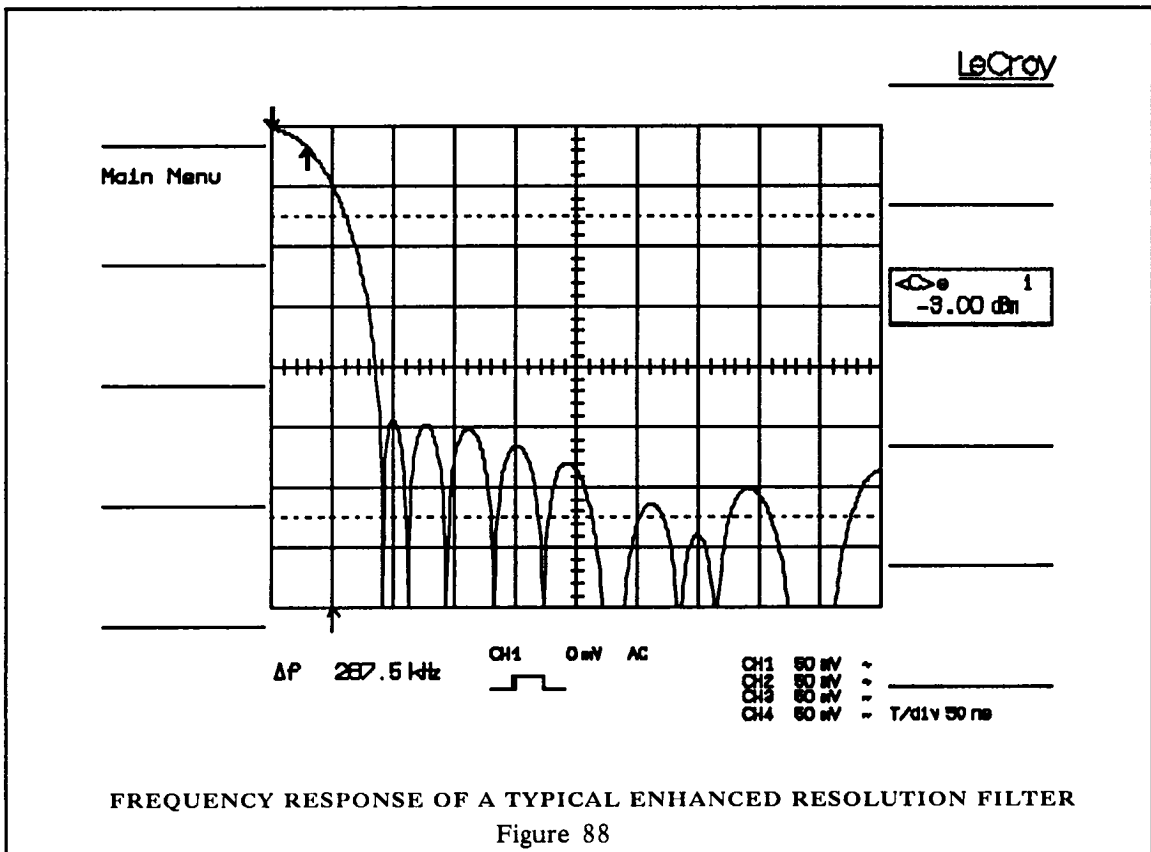

Figure 87 shows the effect of enhanced resolution filtering on a low-frequency signal which has high-frequency interference. The lower grid shows two traces. The bottom one is the original trace with high-frequency interference. The trace above is the same signal after the 2.5-bit enhancement filter has removed the 35 MHz interference. The upper grid shows the Fourier transform of the signals in the lower grid, again with the filtered signal above. The -3 dB bandwidth of the filter in this case is 1.4 MHz, which corresponds to just over a quarter of a horizontal division. It is clear that the filter has removed almost everything above 1.4 MHz, and the

ursors show that the interfering signal has been attenuated by 62 dB. In this case averaging many traces would not have the desired effect of removing the interference because the interference is not random.

Cautionary notes

The enhanced resolution function only improves the resolution of a trace, it cannot improve the accuracy or linearity of the original quantization by the 8-bit ADC.



The constraint of good temporal response for the enhanced resolution filters excludes the use of maximally-flat filters. Therefore, the passband will cause slight signal attenuation for signals near the cut-off frequency. One must be aware when using these filters that the highest frequencies passed may be slightly attenuated. The frequency response of a typical enhanced resolution filter (the 2-bit

enhancement filter) is shown in Figure 88. The -3 dB cut-off frequency at 5.8% of the Nyquist frequency is marked.

The filtering must be performed on finite record lengths, therefore the discontinuities at the ends of the record cause data to be corrupted at these points. These data points are not displayed by the oscilloscope and so the trace becomes slightly shorter after filtering. The number of samples lost is exactly equal to the length of the impulse response of the filter used, and thus varies between 2 and 117 samples. Because the oscilloscope has very long waveform memories this loss is not normally noticed (it is only 0.2% of a 50,000 point trace, at worst). However, it is possible to ask for filtering on a record so short that there would be no data output. The oscilloscope will not allow filtering in this case.

The FFT option (WP02) adds the spectrum analysis capability to a 9424 oscilloscope.

Spectra of single time-domain waveforms can be computed and displayed and Power Averages can be obtained over as many as 50,000 spectra.

This section describes the FFT option. The remote commands for the control of FFT processing as well as waveform transfer to and from a host computer are listed in the Remote Control Manual.

FOURIER TRANSFORM

Functions C, D, E and F (buttons (57) and (58)) can be defined as the fast Fourier transform of one of the source waveforms: Expand A, Expand B (56), Function C, Function D (57), Function E, Function F (58), Channel 1 and Channel 2 (59), Channel 3 and Channel 4 (60).

Pressing **Redefine** (button (51)) while Function C, D, E or F is selected accesses the Fourier Transform menu (Figure 89).

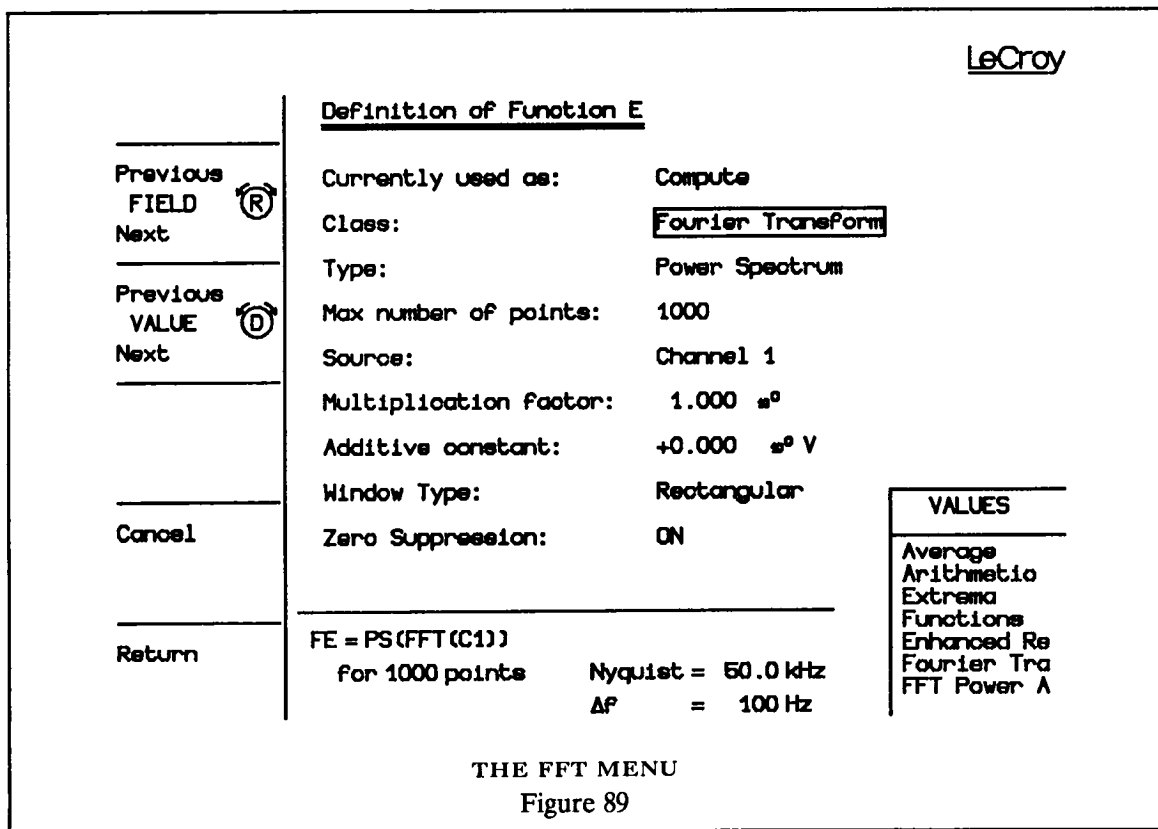

Spectra are displayed with a linear frequency axis running from zero to the Nyquist frequency. The frequency scale factors (Hz/div) are in a 1–2–5 sequence.

The processing equation is displayed at the bottom of the Fourier Transform menu, together with three key parameters which characterize an FFT spectrum:

- 1) Transform Size N (number of input points)
- 2) Nyquist frequency
- 3) Δf (the frequency increment) between two successive points of the spectrum. These parameters are related as follows:

$$\text{Nyquist frequency} = \Delta f * N/2$$

Also note that $\Delta f = 1/T$, where T is the duration of the input waveform record (10 * time/div).

The number of output points is equal to N/2.

The menu allows the user to set the following parameters:

Type

Power Spectrum (dBm) is the signal power (or magnitude) represented on a logarithmic vertical scale. 0 dBm corresponds to the voltage (0.316 V peak) which is equivalent to 1 mW into 50 Ω . The power spectrum is suitable for characterizing spectra which contain isolated peaks.

Power Density (dBm) is the signal power normalized to the bandwidth of the equivalent filter associated with the FFT calculation. The power density is suitable for characterizing broad-band noise.

Magnitude (same units as the input signal) is the peak signal amplitude represented on a linear scale.

Phase (degrees) is measured with respect to a cosine whose maximum occurs at the left-hand edge of the screen, at which point it has 0°; similarly, a positive-going sine starting at the left-hand edge of the screen has –90° phase.

Real, Imaginary and Real + Imaginary (same units as the input signal) represent the complex result of the FFT processing.

Max Number of Points

FFT spectra are computed over all of the source time-domain waveform. This parameter limits the number of points used for FFT processing. If the input waveform contains more points than the selected maximum, these are decimated prior to FFT processing. If the input waveform has fewer points, all points are used. The actual number of points used (**Transform Size**) is displayed at the bottom of the menu screen.

Source	Allows the user to select the source signal for FFT. Available sources are Expand A , Expand B , Function C , Function D , Function E , Function F , Channel 1 , Channel 2 , Channel 3 and Channel 4 . The source waveform must be a time-domain waveform.
Multiplicative Factor and Additive Constant	These parameters define a linear transformation of the input data prior to the FFT calculation.
Window Type	<p>The window type defines the bandwidth and shape of the equivalent filter associated with the FFT processing.</p> <p>The Rectangular window is normally used when:</p> <ol style="list-style-type: none"> a) the signal is a transient which is completely contained in the time-domain window. b) the signal is known to have a fundamental frequency component which is an integer multiple of the fundamental frequency of the window. <p>Signals not in this class show varying amounts of spectral leakage and scallop loss, which can be corrected by using one of the other windows.</p> <p>The popular Von Hann (Hanning) and Hamming windows reduce leakage and improve amplitude accuracy. However, the frequency resolution is also reduced.</p> <p>The Flat Top window provides excellent amplitude accuracy, with moderate reduction of leakage, at the cost of frequency resolution.</p> <p>The Blackman-Harris window reduces the leakage to a minimum, with a trade-off in frequency resolution.</p> <p>Table 5 in the FFT glossary in this section shows the parameters of equivalent filters.</p>
Zero Suppression	When Zero Suppression is turned ON, the DC component of the input signal is forced to zero prior to the FFT processing. This improves the amplitude resolution, especially when the input has a large DC component.
Nyquist Frequency	The Nyquist frequency (the upper limit of the spectrum frequency range) is displayed at the bottom of the menu page (Figure 91), together with the number of points input to the FFT and the frequency resolution, Δf .
FFT on Sequence Waveforms	FFT accepts waveforms consisting of one segment (single sweep or RIS) or several segments (Sequence). Spectra obtained by FFT of

segments constitute a frequency domain sequence. Note that Nyquist frequency, number of points and Δf apply to each individual segment.

FFT POWER AVERAGE

Applications

Power Average is defined as the average sum of squared spectrum magnitude, over many successive sweeps. It is useful for the characterization of broadband noise or of periodic signals for which a stable trigger signal is not available.

Note that this type of averaging measures the total power (signal and noise) at each frequency.

A Function (C, D, E or F) can be defined as the **Power Average** of FFT spectra computed by another Function.

Adjusting the FFT Power Average

Pressing **Redefine** (51) while Function C, D, E or F is selected accesses the **Power Average** menu (Figure 90), which allows the user to adjust the following parameters:

LeCroy

<div style="border-bottom: 1px solid black; padding-bottom: 5px;"> Previous FIELD R Next </div> <div style="border-bottom: 1px solid black; padding-bottom: 5px;"> Previous VALUE D Next </div> <div style="border-bottom: 1px solid black; padding-bottom: 5px; margin-top: 10px;"> Cancel </div> <div style="padding-top: 10px;"> Return </div>	<p><u>Definition of Function F</u></p> <p>Currently used as: Compute</p> <p>Class: FFT Power Average</p> <p>Type: Power Spectrum</p> <p>Source: Function E</p> <p>Max number of sweeps: 250</p> <hr style="border: 0.5px solid black;"/> <p>FF = <FE>p to 250 sweeps</p>
---	---

VALUES
Average
Arithmetic
Extrema
Functions
Enhanced Re
Fourier Tra
FFT Power A

THE FFT POWER AVERAGE MENU

Figure 90

Type	Power Spectrum, Power Density and Magnitude are available. A linear frequency axis runs from 0 to the Nyquist frequency. The frequency scale factors are in a 1–2–5 sequence.
Source	This must be another Function (C, D, E or F) , currently defined as Fourier Transform (any result type).
Max Number of Sweeps	From 1 to 50,000 sweeps can be selected. Averaging stops when the max number of sweeps is reached, and continues if the number is increased.

PROCESSING FACILITIES

Other waveform processing functions such as Averaging and Arithmetic can be applied to waveforms before the FFT processing. Time-domain averaging prior to FFT can be used if a stable trigger is available. It will reduce the random noise in the signal.

The **Time Magnifier** and **Position** controls operating on the FFT output waveforms provide horizontal expansion of up to 1000 times. The Display Control knobs provide vertical expansion (up to 10 times) and control the vertical position of the traces.

The FFT frequency range (i.e. Nyquist frequency) and the frequency resolution can be controlled as follows:

- To increase the frequency resolution, increase the length of the time-domain waveform record (i.e. use a slower time base).
- To increase the frequency range, increase the effective sampling frequency (i.e. increase the **Max number of points** or use a faster time base).

The **Memory Status** menu displays parameters of the waveform descriptor (number of points, horizontal and vertical scale factors and units, etc.).

CURSORS

To read the amplitude and frequency of a data point, the **Absolute Time Cursor** can be moved over into the frequency domain by going beyond the right-hand edge of a time-domain waveform.

The **Relative Time Cursors** can be moved over into the frequency domain to simultaneously indicate the frequency difference and the amplitude difference between two points on each frequency-domain trace.

The **Absolute Voltage Cursor** reads the absolute value of a point in a spectrum in the appropriate units, and the **Relative Voltage Cursors** indicate the difference between two levels on each trace.

FFT INTERRUPTION (ABORT)

During FFT computation the symbol **FFT** is displayed in the lower left-hand corner of the screen (Field (III)). Since the computation of FFT on long time-domain records may take up to 7 seconds, it is possible to interrupt an FFT computation with any front-panel button or knob.

FFT ALGORITHMS

A summary of algorithms used in the 9424's FFT computation is given for reference.

- 1) If the **Max number of points** is smaller than the source number of points, the source waveform data are decimated prior to the FFT. The decimated data cover the full length of the source waveform.

The resulting sampling interval and the actual transform size selected provide the frequency scale factor in a 1-2-5 sequence.

- 2) The data are multiplied by the selected factor, and the selected constant is added.
- 3) If **Zero Suppression** is ON, the DC component of data is computed and is subtracted from the data.
- 4) The data are multiplied by the selected window function.
- 5) FFT is computed, using a fast implementation of the DFT (Discrete Fourier Transform):

$$X_n = \frac{1}{N} \sum_{k=0}^{k=N-1} x_k \times W^{n \times k}$$

where x_k is a complex array whose real part is the modified source time-domain waveform, and whose imaginary part is 0

X_n is the resulting complex frequency-domain waveform

$$W = e^{(-j \times 2 \times \pi / N)}$$

N is the number of points in x_k and X_n

The generalized FFT algorithm, implemented in the oscilloscope, works on N which need not be a power of 2.

- 6) The resulting complex vector X_n is divided by the coherent gain of the window function, to compensate for the loss of the signal energy due to windowing. This compensation provides accurate amplitude values for isolated spectrum peaks.
- 7) The real part of X_n is symmetric around the Nyquist frequency, that is:

$$R_n = R_{N-n}$$

while the imaginary part is asymmetric, that is:

$$I_n = -I_{N-n}$$

The energy of the signal at a frequency n is distributed equally between the first and the second halves of the spectrum; the energy at frequency 0 is completely contained in the 0 term.

The first half of the spectrum (Re, Im), from 0 to the Nyquist frequency is kept for further processing and doubled in amplitude:

$$R'_n = 2 \times R_n \quad 0 \leq n < N/2$$

$$I'_n = 2 \times I_n \quad 0 \leq n < N/2$$

- 8) The resultant waveform is computed for the spectrum type selected.

If **Real**, **Imaginary** or both are selected, no further computation is needed. The appropriate part of the complex result is given as the result (R'_n or I'_n or $R'_n + jI'_n$, as defined above).

If **Magnitude** is selected, the magnitude of the complex vector is computed as:

$$M_n = \sqrt{R_n'^2 + I_n'^2}$$

Steps (1) to (8) above lead to the following result:

An AC sine wave of amplitude 1.0 V with an integral number of periods N_p in the time window, transformed with the rectangular window, results in a fundamental peak of 1.0 V magnitude in the spectrum at frequency $N_p \times \Delta f$.

However, a DC component of 1.0 V, transformed with the rectangular window, results in a peak of 2.0 V magnitude at 0 Hz.

The waveforms for the other available spectrum types are computed as follows:

$$\text{Phase: angle} = \arctan (I_n/R_n) \quad M_n > M_{min}$$

$$\text{angle} = 0 \quad M_n \leq M_{min}$$

where M_{min} is the minimum magnitude, fixed at about 0.001 of the full scale at any gain setting, below which the angle is not well defined.

dBm Power Spectrum:

$$dBm \text{ PS} = 10 \times \log_{10} \left(\frac{M_n^2}{M_{ref}^2} \right) = 20 \times \log_{10} \left(\frac{M_n}{M_{ref}} \right)$$

where $M_{ref} = 0.316 \text{ V}$ (that is, 0 dBm is defined as a sine wave of 0.316 V peak or 0.224 V RMS, giving 1.0 mW into 50 Ω).

The “dBm Power Spectrum” is the same as “dBm Magnitude”, as suggested by the above formula.

dBm Power Density:

$$dBm \text{ PD} = dBm \text{ PS} - 10 \times \log_{10} (\text{ENBW} \times \Delta f)$$

where ENBW is the equivalent noise bandwidth of the filter corresponding to the selected window

Δf is the current frequency resolution (bin width)

- 9) The FFT Power Average takes the complex frequency-domain data R'_n and I'_n for each spectrum generated in step (7) above, and computes the square of the magnitude

$$M_n^2 = R_n'^2 + I_n'^2,$$

sums M_n^2 and counts the accumulated spectra. The total is normalized by the number of spectra and converted to the selected result type using the same formulae as are used for the Fourier Transform.

EXAMPLES OF FFT PROCESSING

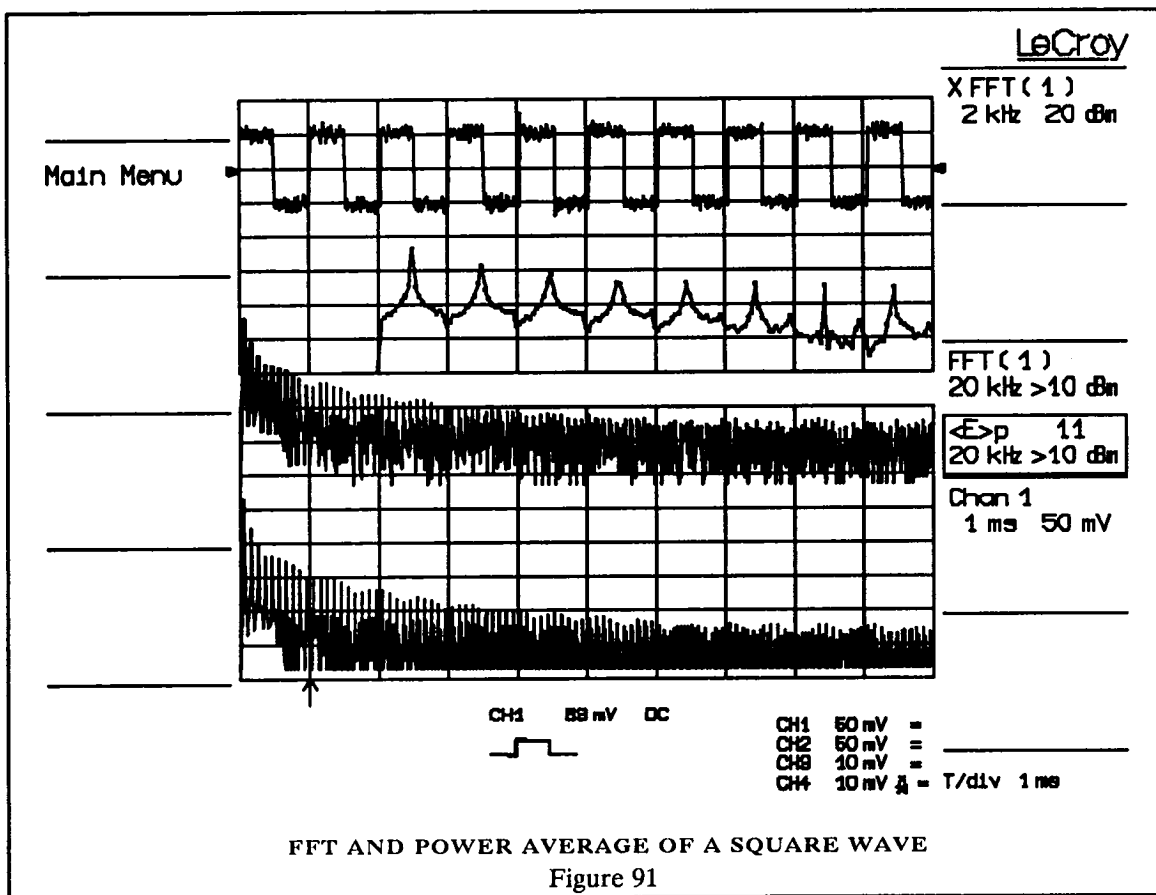

FFT AND POWER AVERAGE OF A SQUARE WAVE

Figure 91

Figure 91 shows an FFT and a Power Average of an FFT of a square wave signal.

Channel 1 (top trace) contains a 1 kHz, 100 mVpp square wave.

Function E (third from the top) is defined as the FFT of Channel 1, with the **Max number of points** set to 5000, resulting in a **Transform Size** of 4000. The **Window** is **Rectangular** and **Zero Suppression** is **ON**. Type has been set to **Power Spectrum**.

Function F (bottom trace) is the **Power Average** of Function E and has averaged 11 spectra. Notice the lowered noise floor.

Expansion A (second from the top) shows a tenfold horizontal expansion of the FFT (Function E).

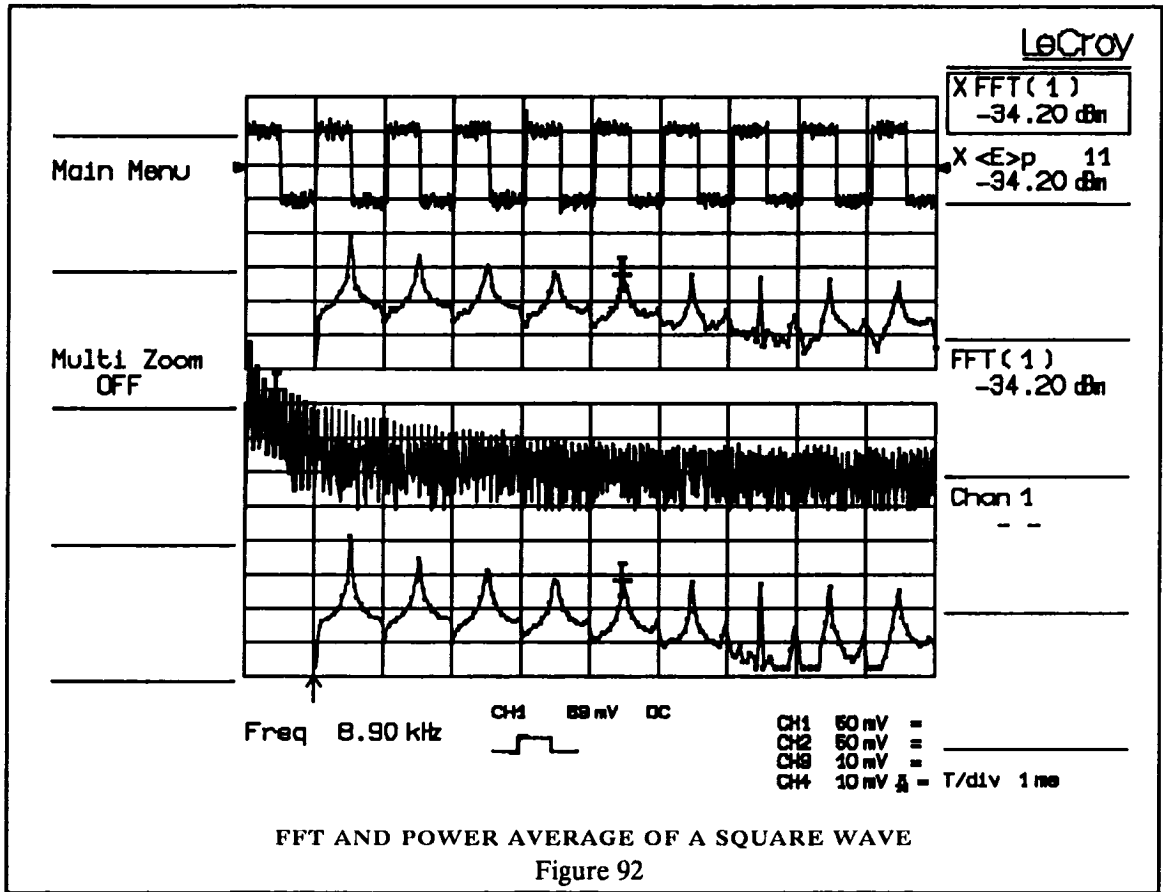

Figure 92 shows a situation similar to Figure 91.

Expansion B shows a 10× horizontal expansion of Function F, the Power Average (11 spectra accumulated and averaged).

The Absolute Time Cursor is turned on and placed on the 9th harmonic of the 1 kHz square wave.

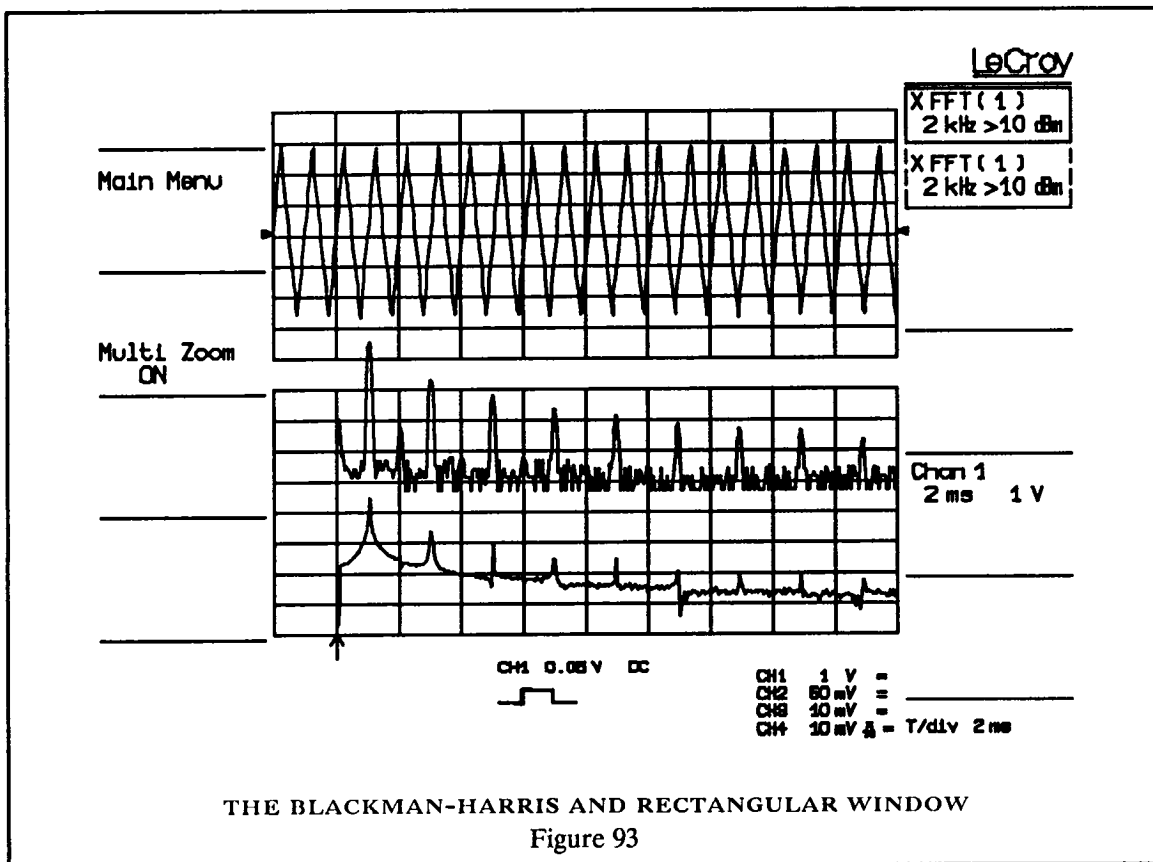

Figure 93 illustrates an example with spectral leakage and the use of an appropriate window to reduce the leakage.

Channel 1 (top trace) shows a triangular wave, approximately 1 kHz frequency.

Expansion B (bottom trace) is an expansion of an FFT with a **Rectangular** window. Each peak, and especially the fundamental component at 1 kHz, influences the spectrum over a wide range of frequencies due to the leakage of the signal power through the side lobes of the equivalent filter.

Expansion A (middle trace) is an expansion of another FFT of the same Channel 1 waveform, defined with the **Blackman-Harris** window. The leakage is clearly reduced, but the peaks around the harmonics are wider. This reflects the increased bandwidth of the filter associated with the Blackman-Harris window.

FFT GLOSSARY

This glossary defines terms frequently used in FFT spectrum analysis and relates them to the oscilloscope.

Aliasing

If the input signal to a sampling acquisition system contains components whose frequency is greater than the Nyquist frequency (half the sampling frequency), there will be less than two samples per signal period. The result is that the contribution of these components to the sampled waveform will be indistinguishable from that of components below the Nyquist frequency. This is called aliasing.

The FFT definition menu displays the effective Nyquist frequency. The user should select the time base and transform size resulting in a Nyquist frequency higher than the highest significant component in the time-domain record.

Coherent Gain

The normalized coherent gain of a filter corresponding to each window function is 1.0 (0 dB) for a rectangular window and less than 1.0 for other windows. It defines the loss of signal energy due to the multiplication by the window function. In the 9424 this loss is compensated. Table 5 lists the values for the windows implemented.

ENBW (Equivalent Noise Bandwidth)

For a filter associated with each frequency bin, ENBW is the bandwidth of an equivalent rectangular filter (having the same gain at the center frequency) which would collect the same power from a white noise signal. In Table 5, ENBW is listed for each window function implemented and is given in bins.

Window type	Highest side lobe gain (dB)	Scallop loss (dB)	ENBW (bins)	Coherent gain (dB)
Rectangular	- 13	3.92	1.0	0.0
von Hann	- 32	1.42	1.5	- 6.02
Hamming	- 43	1.78	1.37	- 5.35
Flat-Top	- 44	0.01	2.96	-11.05
Blackman-Harris	- 67	1.13	1.71	- 7.53

Window Frequency-domain Parameters
Table 5

Filters	<p>Computing an N-point FFT is equivalent to passing the time-domain input signal through N/2 filters and plotting their outputs against the frequency. The spacing of filters is $\Delta f = 1/T$ while the bandwidth depends on the window function used (see Frequency bins).</p>
Frequency bins	<p>The FFT algorithm takes a discrete source waveform, defined over N points, and computes N complex Fourier coefficients, which are interpreted as harmonic components of the input signal.</p> <p>For a real source waveform (imaginary part equals 0), there are only N/2 independent harmonic components.</p> <p>An FFT corresponds to analyzing the input signal with a bank of N/2 filters, all having the same shape and width, and centered at N/2 discrete frequencies. Each filter collects the signal energy that falls into the immediate neighborhood of its center frequency, and thus it can be said that there are N/2 "frequency bins".</p> <p>The distance, in Hz, between the center frequencies of two neighboring bins is always:</p> $\Delta f = 1/T$ <p>where T is the duration of the time-domain record in seconds.</p> <p>The width of the main lobe of the filter centered at each bin depends on the window function used. The rectangular window has a nominal width at 1.0 bin. Other windows have wider main lobes (see Table 5).</p>
Frequency Range	<p>The range of frequencies computed and displayed in the 9424 is 0 Hz (displayed at the left-hand edge of the screen) to the Nyquist frequency (displayed at the right-hand edge of the screen).</p>
Frequency Resolution	<p>In a simple sense, the frequency resolution is equal to the bin width, Δf. That is, if the input signal changes its frequency by Δf, the corresponding spectrum peak will be displaced by Δf. For smaller changes of frequency, only the shape of the peak will change.</p> <p>However, the effective frequency resolution (i.e. the ability to resolve two signals whose frequencies are almost the same) is further limited by the use of window functions. The ENBW value of all windows other than the rectangular is greater than Δf, i.e. greater than the bin width. Table 5 lists the ENBW value for the windows implemented.</p>

Leakage

Observe the power spectrum of a sine wave having an integral number of periods in the time window (i.e. the source frequency equals one of the bin frequencies) using a rectangular window. The spectrum contains a sharp component whose value reflects accurately the source waveform's amplitude. For intermediate input frequencies this spectral component has a lower and broader peak.

The broadening of the base of the peak, stretching out into many neighboring bins is termed the leakage. It is due to the relatively high side lobes of the filter associated with each frequency bin.

The filter side lobes and the resulting leakage are reduced when one of the available window functions is applied. The best reduction is provided by the **Blackman-Harris** and the **Flat Top** windows. However, this reduction is offset by a broadening of the main lobe of the filter.

Numbers of Points

FFT is computed over the number of points (**Transform Size**) whose upper bounds are the source number of points and the **Max number of points** selected in the **Fourier Transform** menu. The effective transform size (number of points input to FFT) **N** is displayed at the bottom of the menu.

FFT generates spectra having $N/2$ output points.

Nyquist Frequency

The Nyquist frequency is equal to one half of the effective sampling frequency (after the decimation), i.e. $\Delta f \times N/2$.

The value of Nyquist frequency is displayed at the bottom of the **Fourier Transform** menu.

Picket Fence Effect

If a sine wave has a whole number of periods in the time domain record, the power spectrum obtained with a rectangular window will have a sharp peak, corresponding exactly to the frequency and amplitude of the sine wave. On the other hand, if a sine wave does not have a whole number of periods in the record, the spectrum peak obtained with a rectangular window will be lower and broader.

The highest point in the power spectrum can be 3.92 dB lower (1.57 times) when the source frequency is halfway between two discrete bin frequencies. This variation of the spectrum magnitude is called the picket fence effect (the loss is called the scallop loss).

All window functions compensate this loss to some extent, but the best compensation is obtained with the **Flat Top** window (see Table 5).

Power Spectrum The power spectrum (V^2) is the square of the magnitude spectrum. The power spectrum is displayed on the dBm scale, with 0 dBm corresponding to $V_{ref}^2 = (0.316 V_{peak})^2$, where V_{ref} is the peak value of the sinusoidal voltage which is equivalent to 1 mW into 50Ω .

Power Density Spectrum The power density spectrum (V^2/Hz) is the power spectrum divided by the equivalent noise bandwidth of the filter, in Hz. The power density spectrum is displayed on the dBm scale, with 0 dBm corresponding to (V_{ref}^2/Hz) .

Sampling Frequency The time-domain records are acquired at sampling frequencies which depend on the selected time base (consult the sampling rate tables in Section 5). Before the FFT computation, the time-domain record may be decimated. If the selected maximum number of points is lower than the source number of points, the effective sampling frequency is reduced. The effective sampling frequency equals twice the Nyquist frequency (displayed in the Fourier Transform menu).

Scallop Loss Loss associated with the picket fence effect (listed in Table 5 for windows implemented).

Window Functions All available window functions belong to the sum of cosines family with one to three non-zero cosine terms:

$$w_k = \sum_{m=0}^{m=M-1} a_m \cos \left(\frac{2 \pi k}{N} m \right) \quad 0 \leq k < N$$

- where $M = 3$ is the maximum number of terms
- a_m are the coefficients of the terms
- N is the number of points of the decimated source waveform
- k is the time index

Table 6 lists the coefficients a_m .

The window functions, seen in the time domain are symmetric around the point $k = N/2$, (mid-screen on the oscilloscope).

Window type	a0	a1	a2
Rectangular	1.0	0.0	0.0
von Hann	0.5	-0.5	0.0
Hamming	0.54	-0.46	0.0
Flat-Top	0.281	-0.521	0.198
Blackman-Harris	0.423	-0.497	0.079

Coefficients of Window Functions
Table 6

ERROR MESSAGES

For some combinations of source waveform properties and processing functions, one of the following error messages may be displayed at the top of the screen:

Incompatible input record type

FFT power average is defined only on a Function defined as FFT.

Horizontal units don't match

FFT of a frequency-domain waveform is not available.

FFT source data zero filled

If there are invalid data points in the source waveform (at the beginning or at end of the record), these are replaced by zeros before FFT processing.

FFT source data over/underflow

The source waveform data has been clipped in amplitude, either in the acquisition (gain too high or inappropriate offset) or in previous processing. The resulting FFT contains harmonic components which would not be present in the unclipped waveform.

The settings defining the acquisition or processing should be changed to eliminate the over/underflow condition.

Circular computation

A Function definition is circular (i.e. the Function is its own source, indirectly via another Function or Expansion). One of the definitions should be changed.

REFERENCES

Bergland, G. D., "A Guided Tour of the Fast Fourier Transform", IEEE Spectrum, July 1969, pp. 41 - 52.

A general introduction to FFT theory and applications.

Harris, F. J., "On the Use of Windows for Harmonic Analysis with the Discrete Fourier Transform", Proceedings of the IEEE, vol 66, No 1, January 1978, pp. 51 - 83.

Classical paper on window functions and their figures of merit, with many examples of windows.

Brigham, E. O., "The Fast Fourier Transform", Prentice Hall, Inc., Englewood Cliffs, N. J., 1974.

Theory, applications and implementation of FFT. Includes discussion of FFT algorithms for N not a power of 2.

Ramirez, R. W., "The FFT Fundamentals and Concepts", Prentice Hall, Inc., Englewood Cliffs, N. J., 1985.

Practice oriented, many examples of applications.



MEMORY-CARD
FEATURES

The Memory Card Option (MCO1) adds fast permanent storage capacity for waveforms and front-panel settings to the standard LeCroy oscilloscopes. Data are stored to the card according to the PCMCIA/JEIDA standard, providing full compatibility with standard DOS disks.

The memory card provides the following key features:

1. A very fast storage media for:
 - Waveforms (acquired, stored or processed).
 - Front-panel settings.
 - Waveform template (an ASCII text detailing the structure of a waveform).
2. An **Autostore** function which provides automatic storage of selected waveforms after each acquisition.
3. On-screen scrolling of waveform files.

		Memory Card of 13-Feb-1991 13:59:56				
Previous FILE (R)		Card size: 126464 bytes, 96256 bytes free				
Next		Waveform will be retrieved to Memory C				
Dest. trace (D)		Contents:				
Waveform store menu		#				Bytes
Retrieve AC1.001		1	P001	PNL	13-Feb-1991 14:00:02	1779
Delete		2	SC1	001	13-Feb-1991 14:00:12	409
Store Panel		3	SC1	002	13-Feb-1991 14:00:20	409
Format Card		4	LECROY21	TPL	13-Feb-1991 14:00:28	21545
Return		5	P002	PNL	13-Feb-1991 14:00:36	1779
		6	AEA	001	13-Feb-1991 14:00:42	409
		7	AMC	001	13-Feb-1991 14:00:42	409
		8	AMD	001	13-Feb-1991 14:00:42	409
		9	AC1	001	13-Feb-1991 14:00:42	409
		10	AC2	001	13-Feb-1991 14:00:42	409

EXAMPLE OF MEMORY CARD MENU

Figure 94

MEMORY-CARD OPERATION

Memory-card menus

To access the memory card menus, press the **Memory Card** softkey (7) in the **Main Menu**. If a card is inserted in the memory card reader, a directory of the card will be listed on the screen (See Figure 94).

By pressing the softkeys in this menu, you can:

- **Format the card.** Before you use a memory card for the first time, you have to format it, as you would do for a floppy disc. This operation performs a DOS standard formatting of the card (or, more precisely, a PCMCIA/JEIDA format with a DOS structure).
- **Store the panel.** This key stores the current front-panel settings onto the card.
- **Delete a selected file.** To select a file in the directory, use the **Previous** (2) and **Next** (3) softkeys, or the **Reference knob** (48).
- **Retrieve a selected file:** Only files containing either a waveform or a front-panel setup can be retrieved. For any other file this button will have no effect.
- If the selected file contains a waveform, this waveform will be copied to the selected destination trace. If the selected file contains a front-panel setup, the current setup of the oscilloscope will be replaced by the one stored on the card.
- To select a file in the directory, use the **Previous** (2) and **Next** (3) softkeys, or the **Reference knob** (48). To select a destination trace, use either the **Dest Trace** softkey (4) or the **Difference knob** (46).
- **Access the Waveform Store menu.**

The **Waveform Store** menu allows you to:

- Choose the format of the data you are storing to the card: **Byte** (8-bit) or **Word** (16-bit).

*Note: The format **Byte** stores only the high order bits of the internal 16-bit representation of the data. The precision contained in the low order bits is lost.*

- Toggle the selection of the traces to be stored using the **Trace On/Off** buttons on the right of the screen.
- Select the **Autostore** mode to automatically store waveforms after each completion of an acquisition.

*Note: In **Sequence mode**, the waveform is stored only after ALL the segments have been acquired.*

Two kinds of **Autostore** mode can be selected: **Fill Card** stores acquired waveforms until the card becomes full, and **Wrap Around** stores continuously to the card, discarding the oldest autostored files in a first-in-first-out manner.

- The **Previous Field** and **Next Field** buttons, or the **Reference** cursor knob, the **Previous Value** and **Next Value** buttons or the **Difference** cursor knob, allow you to make appropriate selections.

The space required on the card for storing all the selected traces is indicated at the bottom of the screen.

The **Store (1)** button or the **Trace On/Off** buttons (56) to (60) also allow you to carry out simple memory-card operations.

Figure 95 shows the memory card **Waveform Store** menu.

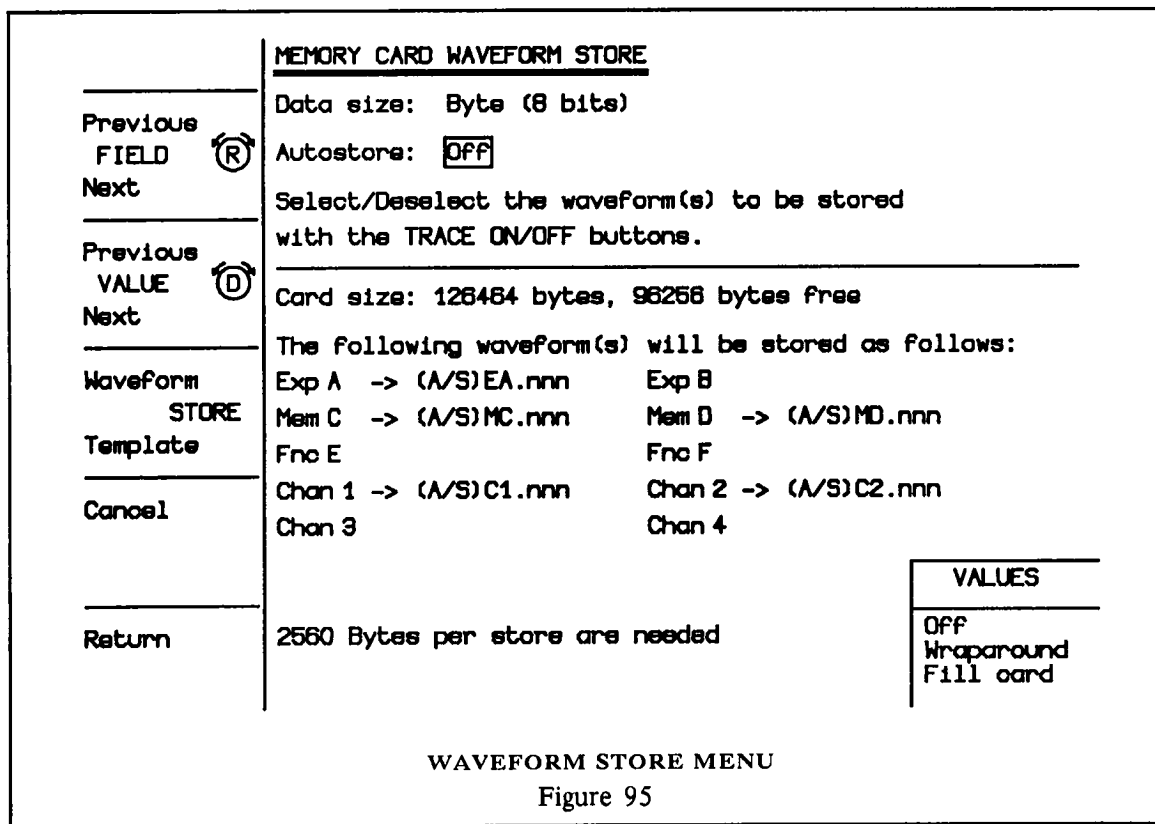

Storage

The **Store** button (1) accesses the standard storage menu which shows two memory-card related softkeys (Figure 96):

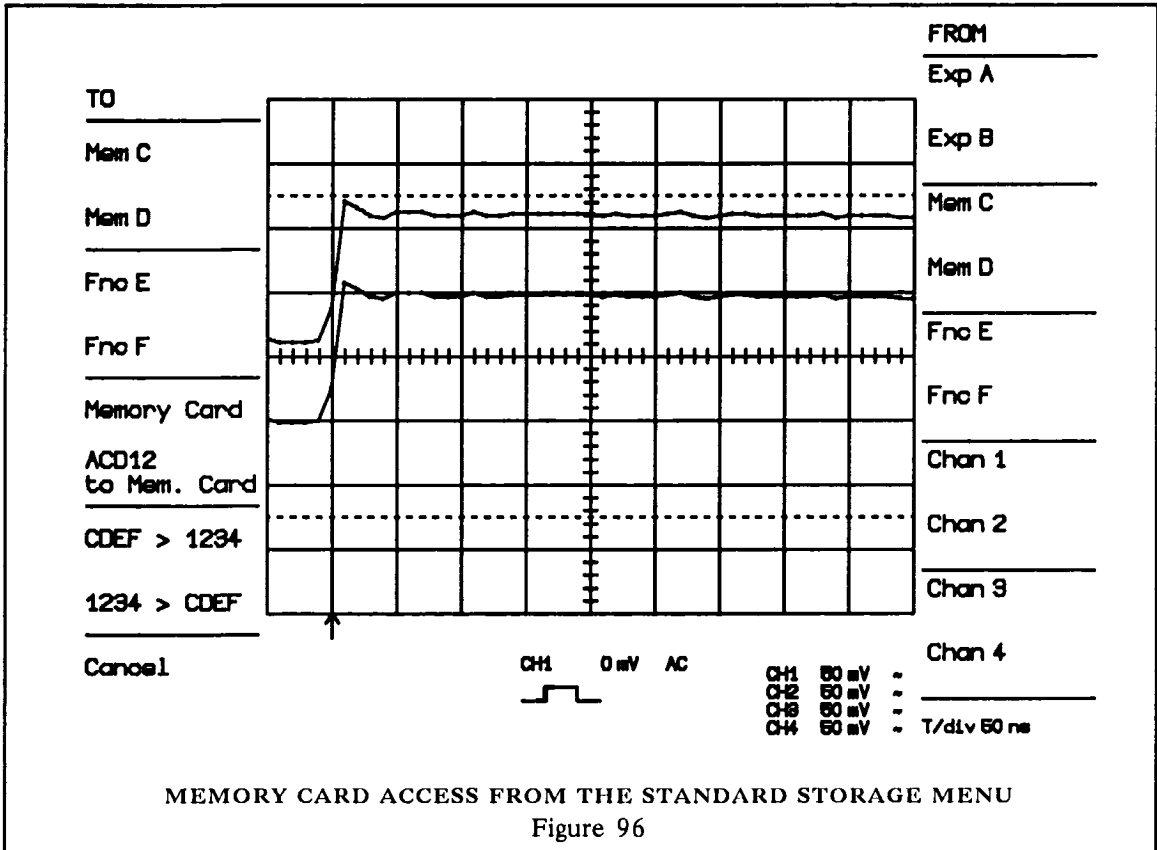

- The **Memory Card** softkey will store ONE trace selected from the right hand side menu on the screen.
- The **To Mem. Card** softkey stores ALL the waveforms that have been previously selected in the **Waveform Store** sub-menu of the **Memory Card** menu. In Figure 96, "ACD12 to Mem. Card" means that Expand A, Memory C, Memory D, Channel 1 and Channel 2, will be stored on the card.

Note: This key is disabled if no traces have been selected in the Waveform Store sub-menu.

Retrieval

If you display a trace (using Trace On/Off buttons (56) to (60)) and if this trace has been selected as the destination trace in the Memory Card menu, then two new keys will appear in the root menu (See Figure 97): **Previous Saved Wave** and **Next Saved Wave** softkeys allow you to scroll through the memory-card directory in order to see on the screen the different traces stored on the card.

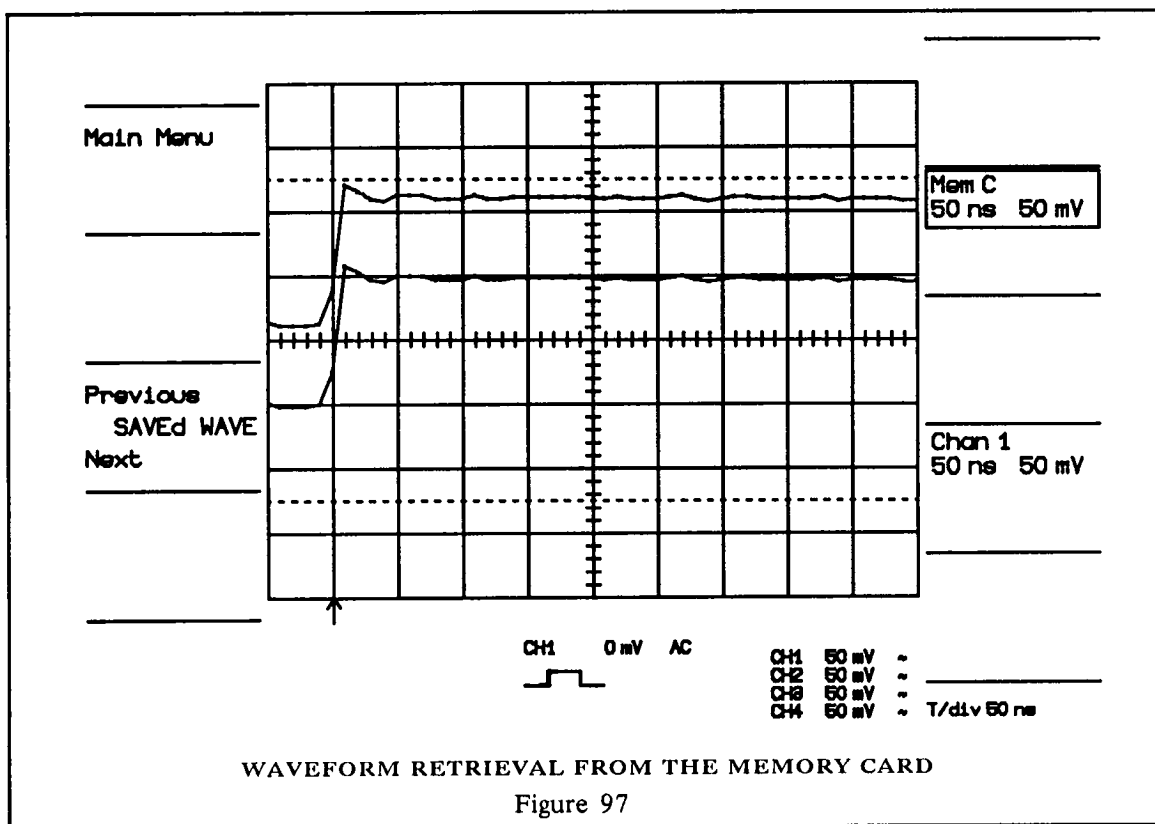

FILE NAMING

When storing on the memory card, the oscilloscope generates the file names and their respective extensions according to the following rules:

- Front-panel setups: Pnnn.PNL
- Waveforms: XYY.nnn
- Waveform template LECROYvv.TPL

Where nnn: a 3-digit decimal number

- X:** **A** when the trace was stored automatically by the Austostore mode.
 S when the trace was stored by a single manual operation
- YY:** indicates the origin of the trace as follows:
 Cl, C2, C3, C4: the respective channel memory.
 MC, MD, FE, FF: the respective reference or function memory
 EA, EB: Expand A and Expand B
- VV:** a 2-digit decimal number representing the version number of the waveform template.

MEMORY-CARD STRUCTURE

MC Format

The Memory Card's structure, based on the PCMCIA 1.0/JEIDA 4.0 standard, consists of a DOS partition containing files as in any DOS floppy or hard disk.

When the card is formatted by the oscilloscope it is segmented in contiguous sectors of 512 bytes each. The oscilloscope does not support error detection algorithms such as CRC's or checksum that are inserted between the sectors. In this case, the oscilloscope may still be able to read the card but be unable to write to the card.

LeCroy Subdirectory

All the files are written to the card in a subdirectory called LECROY_1.DIR. This directory is automatically created when the card is formatted. If the card has been formatted elsewhere – for instance in a PC – the directory will be created the first time a file is stored to the memory card.

File-naming Structure

As in MS-DOS, the file name can take up to 8 characters followed by an extension of 3 characters.

A file is treated as:

- a Panel setup if its extension is PNL.
- a Waveform if its extension is a 3-digit number.
- a Waveform Template if its extension is TPL.

If the file you are storing carries the same name as a file already on the card, the old file will be deleted.

In local mode, predefined filenames are used as follows:

- Panels: **Pnnn.PNL**. nnn denotes a 3-digit decimal sequence number. The first panel saved on the card will be P001.PNL, the second will be P002.PNL, etc.

- Waveform: **Axx.nnn** or **Sxx.nnn**. **xx** defines the trace name:
 - C1, C2, C3, C4 for Channel 1, Channel 2, Channel 3, Channel 4 traces.
 - EA, EB for Expanded traces.
 - MC, MD, FE, FF for reference Memory or Function traces.

The file's first letter **A** stands for an autostored file, while **S** stands for a normal file. When using the **STORE** remote command, a filename beginning with an "A" character will be refused because it would create confusion with an Autostored file.

nnn denotes a 3-digit decimal sequence number. The first "Channel 1" waveform stored to the card will be **SC1.001**, the second will be **SC1.002**, etc.

- Template: **LECROYxx.TPL**. **xx** stands for the version of the template. If the version is 2.1 for example, the template file will be saved as **LECROY21.TPL**.

More on Autostored Files

If the "Fill Card" option is selected, the first waveform stored will be **Axx.001**, the second **Axx.002**, and so on until the card is full or until the file number reaches 999.

If the "Wrap Around" option is selected, the oldest autostored waveform files will be deleted whenever the card becomes full. Remaining autostored waveform files are renamed, the oldest group of files being named "Axx.001", the second oldest "Axx.002", etc.

Write Protect Switch

At the back of the memory card, you will find a write protection switch that may be activated to prevent writing to the card. A "WRITE PROT." message will then be displayed on the upper right corner of the memory card menu.

Battery

Every SRAM memory card contains a small battery to preserve the data. It is a button-size type **BC2325** or **CR2325** battery and it can be changed when necessary. The oscilloscope will warn you with a "BAD BATTERY" message that the battery has to be changed. To access the battery, remove the small lid on the upper edge of the card. The battery can be changed even when the memory card is still installed in the oscilloscope.

INDEX

A

- Abridged Trigger Field, 16–17
- Accuracy
 - Amplitude Measurements, 157–160
 - Time Measurements, 159–162
- Accuracy DC, 6
- Acquisition, 133
 - Fast repetitive signals, 137–138
 - Sequence, 29–30, 141, 144
 - Single-shot, 23, 138–140
 - Slow signals, 140–141
- Acquisition Modes, 7
- Addition/subtraction, 38
- Aliasing. *See* WP02 FFT Processing
- Amplitude Measurements, 157–160
- Arithmetic, 37–38
 - See also* WP01 Waveform Processing
- Assistance, 1
- Automatic Calibration, 5, 12, 161–162
- Automatic Setup, 11, 49, 134
- Auxiliary Setups, 62
- Averaging, 37–38
 - See also* WP01 Waveform Processing
- Averaging, summed, 155

B

- Bandwidth Limiter, 25
- Batteries, 12
- Bi-level Trigger, 9, 79–81, 100–102

C

- Calibration, Automatic, 5, 12, 161–162
- Connectors
 - Accessory control, 131
 - Accessory power, 129, 130–131
 - External CK input, 131
 - External trigger (9424E), 132

- Sampling CK output, 131
- Trigger out, 131
- Trigger veto, 131
- Continuous Average. *See* WP01 Waveform Processing
- Continuous Sequence Mode, 75–76
- Cursors, 10, 39–42
 - Extended pulse parameters, 125
 - FFT analysis, 187
 - Pass/Fail testing, 116
 - Persistence Display, 72
 - Time, 40–43
 - Voltage, 39
 - XY mode, 69–70
- Customer Service, 1–2

D

- Display Layout, 15–18
- Display of Traces, 32–36
- Display Resolution, 10
- Displayed Trace Field, 17–18

E

- ENBW – Equivalent Noise Bandwidth. *See* WP02 FFT Processing
- Enhanced Resolution. *See* WP01 Waveform Processing
- Expansion. *See* Waveform Expansion
- Extended Pulse Parameters, 123
 - Cursors, 125
 - Display, 123
 - Parameters list, 127
 - Setup, 126
- External Clock Input, 75–76, 131
- External Time-base Control, 75–76
- Extrema. *See* WP01 Waveform Processing

F

Fast Fourier Transform. *See* WP02 FFT Processing
FASTGLITCH, 79, 92–97
FFT Algorithms. *See* WP02 FFT Processing
FFT Power Average. *See* WP02 FFT Processing
FIELDLOCK, 110
Front-panel Setups, 59–61, 145
Functions. *See* WP01 Waveform Processing
Fuses, 129

G

Glitch Detection, 7
Glitch Triggering. *See* Width-based Triggers
GPIB Port Selection, 62, 130
Grids, 38–39

H

Hard Copies, 10, 63–65
Hard Options, 62
HF Trigger Coupling, 26
Hold-off by Time or Number of Events, 78, 88–91, 99
Horizontal Controls, 22–27

I

Icon Field, 16
Intensity, 38
Interval Width Trigger, 94–97
See also Width-based Triggers

L

Leakage, spectral. *See* WP02 FFT Processing

M

Maintenance, 1
Memory Card, 201
 Autostore, 202
 Menus, 202
 Structure, 206
Memory Status Menu, 52–58, 147
Menu Field, 16
Message Field, 18
Multi Grid, 15
Multi Zoom Expansion, 34–36, 149–152
Multi-source Triggers, 79–84, 97
 Pattern, 79–81
 State Qualified, 79
 Time/Event Qualified, 79
 TV Trigger, 79

N

Nyquist Frequency. *See* WP02 FFT Processing

O

Overload, 19

P

Panel Status Menu, 50–52, 147
Parameters (Extended), 123
Pass/Fail Testing, 113
 Cursors, 116
 Display, 114
 Parameters list, 121
 Setup, 117
 Tolerance mask, 118
Pattern Trigger, 9, 79–81, 97–103
Persistence Display, 71
 Cursors, 72
 Selecting traces, 72
Picket Fence Effect. *See* WP02 FFT Processing

Plotting. *See* Hard Copies

Power Density Spectrum. *See* WP02 FFT Processing

Power Spectrum. *See* WP02 FFT Processing

Printing. *See* Hard Copies

Probe Calibrator, 12, 134

- Check, 136
- Connection, 133
- Specifications, 25

Pulse Parameters, 11, 43–47

- Information and warning symbols, 48, 122, 128
- Time measurements, 46–47
- Voltage measurements, 45–46

Pulse Parameters (Extended), 123

Pulse Width Trigger, 91–94

See also Width-based Triggers

R

RAN - Return Authorization Number, 2

Random Interleaved Sampling, 22–23, 137–138

Real-time Clock Field, 16

Recalling Front-panel Setups, 59–61, 145

Recalling Waveforms, 146–147

Remote Control, 5–6, 11–12

Remote Control and Interruption, 49

Reset, 132

Return Procedure, 2

Roll Mode, 23, 140–141

RS-232-C Connector, 130

RS-232-C Port Selection, 62, 130

RS-232-C Setup, 65–66

S

Safety Information, 13

Sampling Clock Output, 131

Sampling Frequency. *See* WP02 FFT Processing

Saving Front-panel Setups, 59–61, 145

Screen Dump, 38–39, 63–65

Sensitivity (Volts/div), 19–22

Sequence Mode, 141–144

Serial Number, 62

Service Procedure, 2

Signal Coupling, 19

Single-shot Acquisition, 23

Single-shot Acquisitions, 138–140

Single-source Triggers, 78–79, 88

- Hold-off, 78
- Width-based Trigger, 78–79

SMART Trigger Menu, 85–87

Soft Options, 62–63

Soft Version, 62–63

Special Modes, 75–76

- Continuous sequence mode, 76
- External time-base control, 75

Specifications, 6

- Bandwidth, 6
- Trigger, 7
- FASTGLITCH, 8
- SMART, 8
- Pattern, 9
- State-qualified, 9
- Time/Event-qualified, 9
- TV, 9–10

State-qualified Trigger, 9, 82, 102–104

Storing Waveforms, 73–74, 146–147

Summed Average, 11, 37–38, 155

See also WP01 Waveform Processing

T

Time and Frequency Field, 16
Time Base, 22–27
Time Measurements, 159–162
Time Setup Menu, 66–67
Time/Event-qualified Trigger, 9, 83,
105–108
Trigger, 4–5
 External (9424E), 132
 Out, 131
 SMART
 Applications, 77–85
 Hold-off, 78
 Pattern, 79–81
 State-qualified, 82
 Time/Event-qualified, 83
 TV trigger, 84
 Width-based triggering, 78–79
 Bi-level, 9, 100–101
 Pattern, 97–103
 Single-source, 88–99
 State-qualified, 102–106
 Time/Events-qualified, 105–108
 TV, 108–111
 Status, 31
 Veto, 131–132
Trigger Controls, Standard, 25–31
 Coupling, 26–27
 HF, 26
 Delay, 27
 Level, 27
 Mode, 28–32
 Slope, 27–28
Trigger Delay Field, 16
Trigger Graphics, 87
Trigger Level Indicator Fields, 18
Trigger Symbols, 31, 87
Trigger Time Stamps, 56–58
TV Trigger, 9, 84, 108–111
 FIELDLOCK, 110

Trigger on a particular field, 9, 109
Trigger on a particular line, 9, 109
Trigger on any line, 9, 109

V

Vertical Controls, 19–22
Voltage, Operating, 13, 129

W

Warranty, 1
Waveform Expansion, 32–36, 147–153,
160–162
Waveform Processing, 11, 36–39, 153–155
 See also WP01 Waveform Processing
 Arithmetic, 153–154
 Addition, 153–154
 Addition/subtraction, 38
 Identity, 38
 Negation, 38, 154
 Averaging, summed, 37–38
Width-based Triggers, 78–79, 91–96,
99–100
Windows. *See* WP02 FFT Processing
WP01 Waveform Processing
 Arithmetic, 168–169
 Continuous averaging, 167–168
 Enhanced resolution, 172–182
 Extrema, 170–171
 Floor, 170–171
 Functions, 171
 Absolute value, 171
 Derivative, 171
 Exponential, 171
 Integral, 171
 Logarithm, 171
 Square, 171
 Square root, 171
 Roof, 170–171
 Summed average, 164–167

Index

WP02 FFT Processing

- Aliasing, 194
- Cursors, 187
- ENBW - Equivalent Noise Bandwidth, 194
- Fast Fourier Transform, 183—186
- FFT algorithms, 188—190
- FFT examples, 191—193
- FFT power average, 186—187
- Glossary, 194—198
- Leakage, spectral, 193, 196
- Nyquist Frequency, 196
- Picket Fence Effect, 196
- Power Density Spectrum, 197

- Power Spectrum, 197
- Sampling Frequency, 197
- Windows, 185, 193, 194, 197—198

X

- XY Display, 68—71
 - Cursors, 69—70
 - Reference point, 70
 - Selecting traces, 69

Z

- Zoom. *See* Waveform Expansion

ADDRESSES

US SALES OFFICES

800-5-LeCroy (automatically connects you to your local sales office)

WORLDWIDE

Argentina: Search SA, (01) 394-5882

Australia: Scientific Devices Pty.Ltd,
(03) 579-3622

Austria: Dewetron Elek. Messgeräte GmbH,
(0316) 391804

Benelux: LeCroy B.V. *31-4902-89285

Brazil: A. Santos, (021) 233 5590

Canada: Rayonics, W. Ontario:
(416) 736-1600
Rayonics, E. Ontario/Manitoba:
(613) 521-8251
Rayonics, Quebec:
(514) 335-0105
Rayonics, W. Canada:
(604) 293-1854

Denmark: Lutronic, (42) 459764

Finland: Labtronic OY, (90) 847144

France: LeCroy Sarl (1) 69073897

Germany: LeCroy GmbH, (06221) 831001
(North) (0405) 42713

Greece: Hellenic S/R Ltd., (01) 721 1140

India: Electronic Ent., (022) 4137096

Israel: Ammo, (03) 453157

Italy: LeCroy S.r.l., Roma (06) 300-9700
Milano (02) 2940-5634
(02) 204 7082

Japan: LeCroy Japan,
Tokyo (0081) 3 376 9400
Osaka (0081) 6 330 0961

Korea: Samduk Science & Ind., Ltd.:
(02) 468 04914

Mexico: Nucleoelectronica SA:
(905) 593 6043

New Zealand: E.C. Gough Ltd.,
(03) 798-740

Norway: Avantec A/S, (02) 630520

Pakistan: Electronuclear Corp.,
(021) 418087

Portugal: M.T. Brandao, Lta.,
(02) 691116

Singapore: Singapore Electronics and
Eng. Ltd., (065) 481 8888

Spain: Tempel SA,
(36) 3323.4278

Sweden: MSS AB, (0764) 68100

Switzerland: LeCroy S.A.
(022) 719 21 11

Taiwan: Topward El. Inst., Ltd.,
(02) 601 8801

Thailand: Measuretronix Ltd.,
(02) 374 2516

United Kingdom: LeCroy Ltd.,
(0235) 33 114

LeCROY CORPORATE HEADQUARTERS

700 Chestnut Ridge Road
Chestnut Ridge, NY 10977-6499
Telephone: (914) 425-2000
TWX:(710) 577-2832
Fax: (914) 425-8967

LeCROY EUROPEAN HEADQUARTERS

2, rue du Pré-de-la-Fontaine
P.O. Box 341
1217 Meyrin 1/Geneva, Switzerland
Tel.: (022) 719 21 11 Telex: 419 058
Fax: (022) 782 39 15

LeCroy

Corporate Headquarters

700 Chestnut Ridge Road
Chestnut Ridge, NY 10977-6499
Tel: (914) 425-2000, TWX: 710-577-2832

European Headquarters

2, rue Pré-de-la-Fontaine
P.O. Box 341
1217 Meyrin 1/Geneva, Switzerland
Tel.: (022) 719 21 11, Telex: 419 058